

# 25-1

ÜRÜN KATALOĞU  
PRODUCT CATALOG



## INDUSTRIAL KITCHEN EQUIPMENT

COOLING

WASHING

FASTFOOD

CARRYING

INOX

HOT





# İÇİNDEKİLER INDEX

SYF/PG

**TEZGAH TİP SOĞUTUCU SERİSİ**  
COUNTER TYPE SERIES

08

**DİKEY TİP SOĞUTUCU SERİSİ**  
VERTICAL TYPE SERIES

28

**SETALTI SOĞUTUCU SERİSİ**  
LOW LEVEL SERIES

42

**HAZIRLIK BUZDOLAPLARI**  
MAKE UP SERIES

54

**ÖZEL SERİ SOĞUTUCULAR**  
SPECIAL COLDLINE

74

**BAR SERİSİ SOĞUTUCULAR**  
BAR SERIES COOLING LINE

94

**UNLU MAMÜL SOĞUTUCULAR**  
BAKERY COOLING LINE

102

**BUZ MAKİNELERİ**  
ICE CUBE MACHINE

116

**MODÜLER SOĞUK ODALAR**  
MODULAR COLD ROOMS

124

**YIKAMA EKİPMANLARI**  
DISWASHER EQUIPMENT

140

**FAST FOOD EKİPMANLARI**  
FAST FOOD EQUIPMENT

158

**TAŞIMA ÜNİTELERİ**  
CARRYING UNITS

182

**MODULER KAHVE BAR TEZGAHLARI**  
MODULAR CAFE BAR COUNTERS

202

**INOX SERVİS EKİPMANLARI**  
INOX SERVICE EQUIPMENT

234

**YARDIMCI PASLANMAZ ÜRÜNLER**  
AUXILIARY INOX PRODUCTS

282

**600 SERİ PİŞİRME EKİPMANLARI**  
600 SERIES HOT LINE

292

**730 SERİ PİŞİRME EKİPMANLARI**  
730 SERIES HOT LINE

320

**ÖZEL SERİ PİŞİRİCİLER**  
SPECIAL COOKING LINE

350



TEZGAH TİP BUZDOLAPLARI  
COUNTER TYPE REFRIGERATORS

DİKEY TİP BUZDOLAPLARI  
VERTICAL TYPE REFRIGERATORS

MAKE UP BUZDOLAPLARI YÜKSEK  
MAKE UP REFRIGERATORS - HIGH

PİŞİRİCİ ALTI BUZDOLAPLARI  
LOW LEVEL REFRIGERATORS

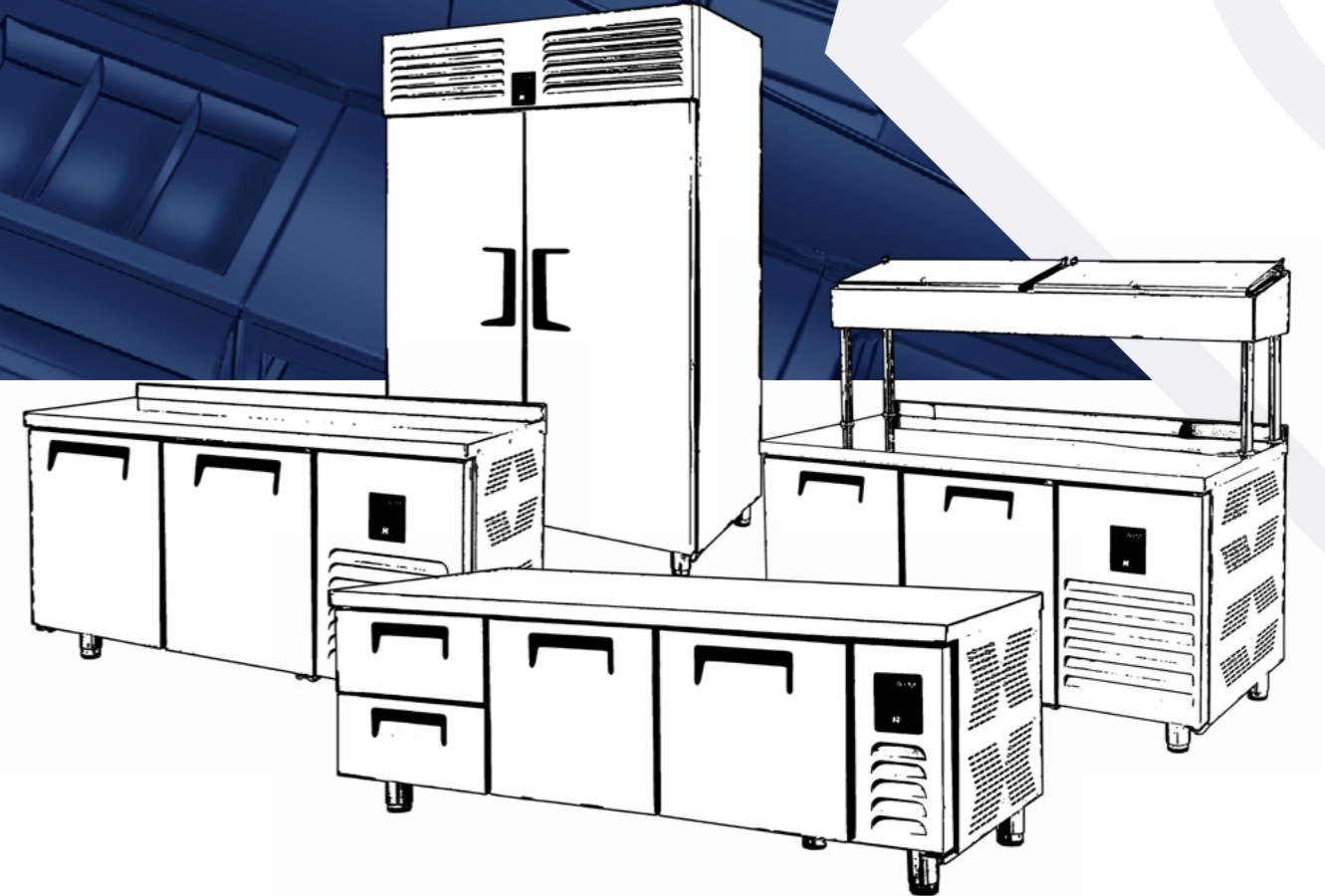

**AIM ENDÜSTRİYEL MUTFAK SAN. VE TİC. LTD. ŞTİ.**

Bu katalog içeriğinde yer alan tüm (yazı, resim, görüntü, fotoğraf) AIM'a ait olup, Fikir ve Sanat Eserleri Kanunu kapsamında korunmaktadır. Bu hakları ihlal eden kişiler, Fikir ve Sanat eserleri Kanunu ve 5237 sayılı Türk Ceza Kanununda yer alan hukuki ve cezai yaptırımlara tabi olurlar. AIM ilgili yasal işlem başlatma hakkına sahiptir.

AIM 257

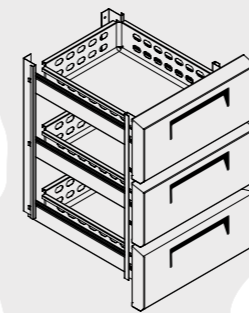
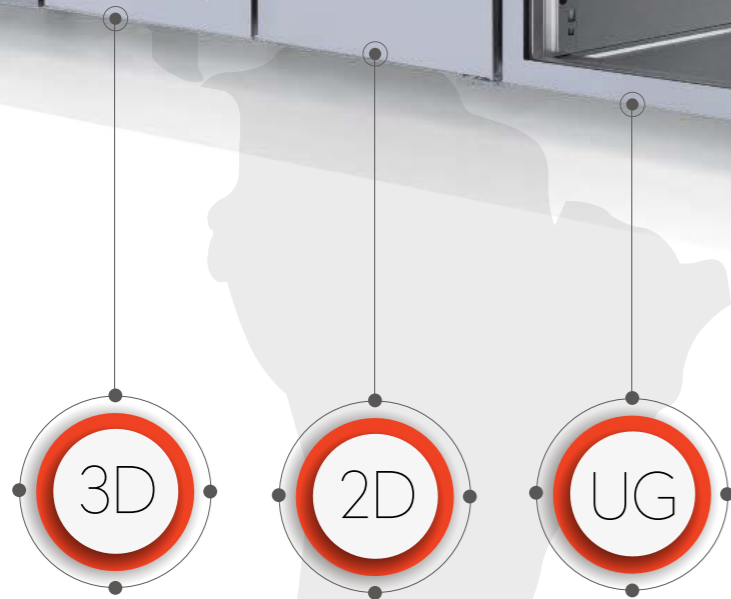
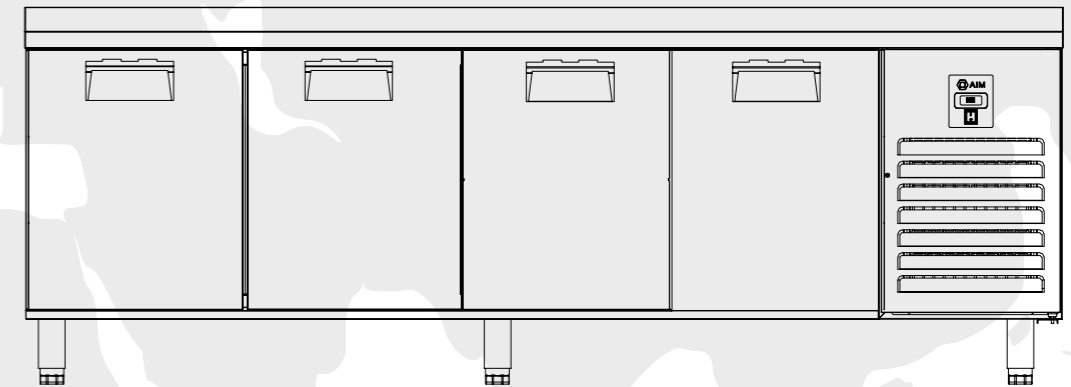

3D

+

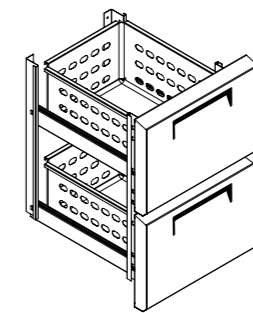

2D

+



UG

AIM 257+3D+2D+UG

# TEZGAH TİP SOĞUTUCU SERİSİ

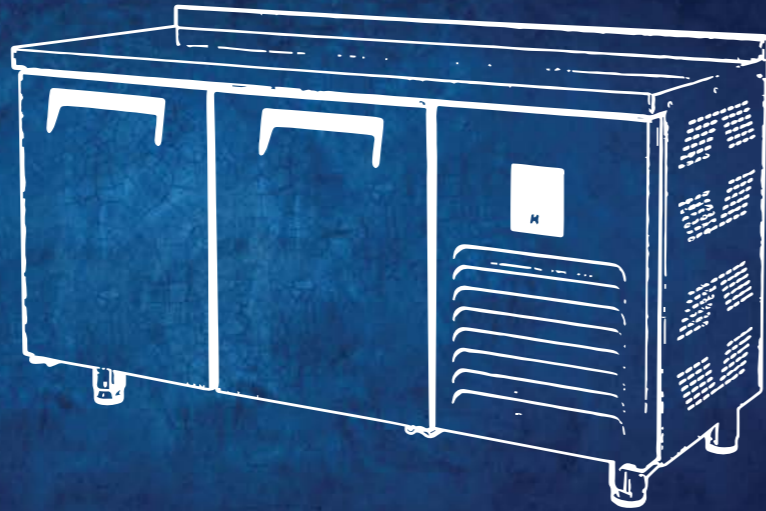

## COUNTER TYPE SERIES

### YENİ KONDENSER SİSTEMİ NEW CONDENSER SYSTEM



CLASSIC

Temizlik gerektirmeyen kondenser  
Stayclear Condenser



AIMCLEAR



### ENERJİ TASARRUFU SAVING ENERGY

Düşük enerji tüketimi sağlayan çevre dostu  
HFC içermeyen poliüretan izolasyon  
Eco friendly, HFC - free polyurethane insulation  
providing low energy consumption

### KUSURSUZ SOĞUTMA SİSTEMİ PERFECT COOLING SYSTEM



CLASSIC



AIMICE

Yekpare evaporatör ile daha verimli hava sirkülasyonu  
More efficient air circulation with one piece evaporator

### EKSTRA İÇ HACİM EXTRA INTERNAL VOLUME



CLASSIC



AIMEX

Yatay konumlandırılan evaporatör sayesinde kullanım kolaylığı ve ekstra iç hacim  
Easy to use and extra internal volume by the help of the horizontally positioned evaporator

### SICAK GAZ DEFROST İLE KARLANMAYAN EVAPARATÖR EVAPARATOR DOES NOT SNOW THROUGH HOT GAS DEFROST



CLASSIC

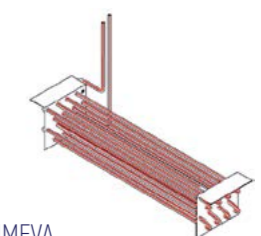

AIMEVA

AIM

AIM 106-107

TEZGAH TİP BUZDOLAPLARI - 1 KAPILI  
COUNTER TYPE REFRIGERATORS - W/1 DOOR

## TEKNİK DETAYLAR / TECHNICAL DETAILS

TR





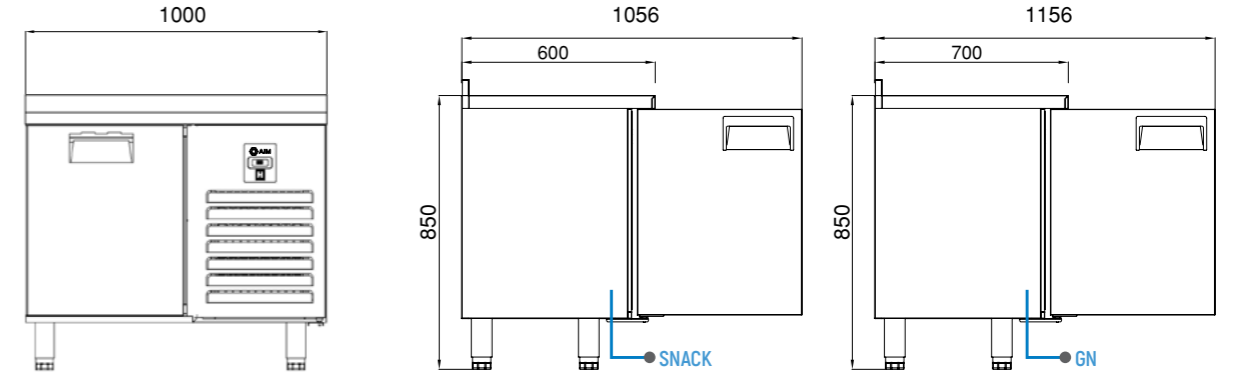

- Dış ortam sıcaklığı +43°C %65 nem oranı
- Eşit sıcaklık dağılımı için yeni tasarım
- Sıfır ODP enjekte 42 kg/m<sup>3</sup> çevre dostu poliüretan izolasyon
- Kolay okunur ekranlı dijital kontrol
- Ergonomik kapı ve kulpu sayesinde kolay açılma ve temizlik
- Patentli 'Icecool' soğutma sistemi ile mükemmel verim ve enerji sarfiyatı
- Sıcak gaz defrost sistemi
- Atık ısı geri kazanımlı kondanzasyon
- Tüm buzdolapların marine versiyonları mevcuttur.
- 1/2 Çekmece için; 1/1-150mm Gn kapasitesi.
- 1/3 Çekmece için; 1/1-100mm Gn kapasitesi.

EN

- Designed to operate in 43°C ambient %65 humidity
- New design for equal temperature distribution
- Zero ODP Injected 42 kg/m<sup>3</sup> Polyurethane Insulation
- Digital controller with easy read screen
- Ergonomic door and handle designed for ease of opening and cleaning
- Icecool refrigeration system designed to be most technologically advanced and energy efficient yet
- Hot gas defrost system
- Waste heat recovery condensate vaporiser system
- All refrigerators can be produced in marine version
- For 1/2 drawers; 1/1-150mm Gn capacity
- For 1/3 drawers; 1/1-100mm Gn capacity

AIM 106-107



| KOD / CODE | 🌡️        |  (MM) |  |  |  (kg) |  (KW) |  | PASLANMAZ TİPİ<br>S.S. TYPE | € |
|------------|-----------|--|---|---|--|--|--|-----------------------------|---|
| AIM 106R3  | -2 / +8   | 1000x600x850   | 125   | 230V - 50Hz   | 65   | 0,16   | R134A  | 304                         | - |
| AIM 106R4  | -2 / +8   | 1000x600x850   | 125   | 230V - 50Hz   | 65   | 0,16   | R134A  | 430                         | - |
| AIM 106F3  | -10 / -22 | 1000x600x850   | 125   | 230V - 50Hz   | 65   | 0,65   | R404A  | 304                         | - |
| AIM 106F4  | -10 / -22 | 1000x600x850   | 125   | 230V - 50Hz   | 65   | 0,65   | R404A  | 430                         | - |
| AIM 107R3  | -2 / +8   | 1000x700x850   | 140   | 230V - 50Hz   | 73   | 0,16   | R134A  | 304                         | - |
| AIM 107R4  | -2 / +8   | 1000x700x850   | 140   | 230V - 50Hz   | 73   | 0,16   | R134A  | 430                         | - |
| AIM 107F3  | -10 / -22 | 1000x700x850   | 140   | 230V - 50Hz   | 73   | 0,65   | R404A  | 304                         | - |
| AIM 107F4  | -10 / -22 | 1000x700x850   | 140   | 230V - 50Hz   | 73   | 0,65   | R404A  | 430                         | - |

R290 İstenildiği takdirde fiyatlara %3 ilave edilir. / For R290 Refrigerant gas, price increase is 3%.

## OPSİYONLAR / OPTIONS

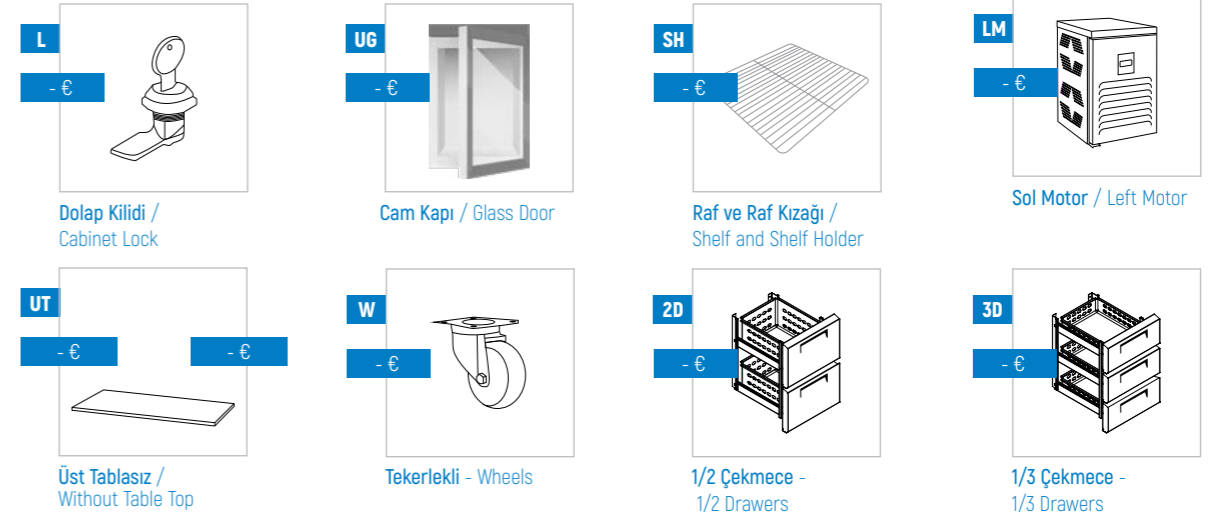

AIM

## AIM 156-157

TEZGAH TİP BUZDOLAPLARI - 2 KAPILI  
COUNTER TYPE REFRIGERATORS - W/2 DOORS

## TEKNİK DETAYLAR / TECHNICAL DETAILS

TR

- Dış ortam sıcaklığı +43°C %65 nem oranı
- Eşit sıcaklık dağılımı için yeni tasarım
- Sıfır ODP enjekte 42 kg/m<sup>3</sup> çevre dostu poliüretan izolasyon
- Kolay okunur ekranlı dijital kontrol
- Ergonomik kapı ve kulpu sayesinde kolay açılma ve temizlik
- Patentli 'Icecool' soğutma sistemi ile mükemmel verim ve enerji sarfiyatı
- Sıcak gaz defrost sistemi
- Atık ısı geri kazanımlı kondansasyon
- Tüm buzdolapların marine versiyonları mevcuttur.
- 1/2 Çekmece için; 1/1-150mm Gn kapasitesi.
- 1/3 Çekmece için; 1/1-100mm Gn kapasitesi.

EN

- Designed to operate in 43°C ambient %65 humidity
- New design for equal temperature distribution
- Zero ODP Injected 42 kg/m<sup>3</sup> Polyurethane Insulation
- Digital controller with easy read screen
- Ergonomic door and handle designed for ease of opening and cleaning
- Icecool refrigeration system designed to be most technologically advanced and energy efficient yet
- Hot gas defrost system
- Waste heat recovery condensate vaporiser system
- All refrigerators can be produced in marine version
- For 1/2 drawers; 1/1-150mm Gn capacity
- For 1/3 drawers; 1/1-100mm Gn capacity

AIM 156-157

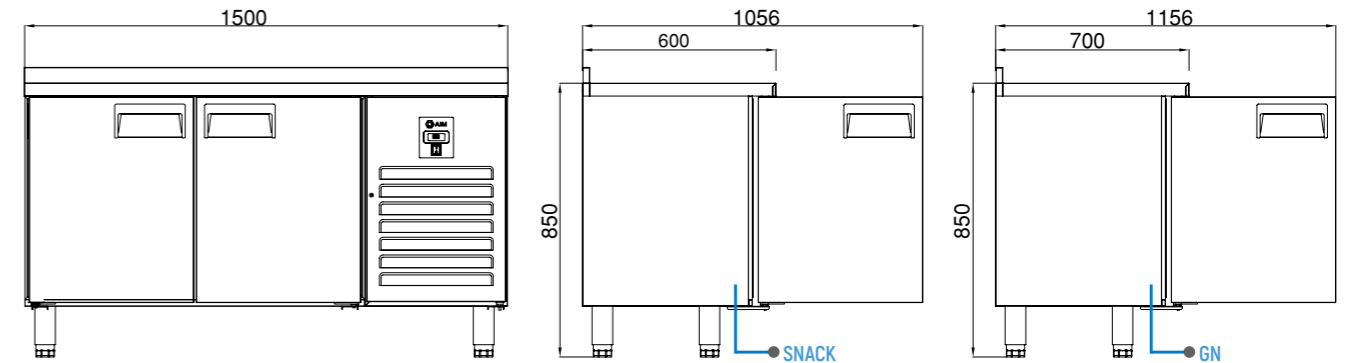

| KOD / CODE | °C        | (MM)         | lt  | 230V - 50Hz | kg  | (KW) | R134A | PASLANMAZ TİPİ<br>S.S. TYPE | € |
|------------|-----------|--------------|-----|-------------|-----|------|-------|-----------------------------|---|
| AIM 156R3  | -2 / +8   | 1500x600x850 | 275 | 230V - 50Hz | 95  | 0,32 | R134A | 304                         | - |
| AIM 156R4  | -2 / +8   | 1500x600x850 | 275 | 230V - 50Hz | 95  | 0,32 | R134A | 430                         | - |
| AIM 156F3  | -10 / -22 | 1500x600x850 | 275 | 230V - 50Hz | 95  | 0,68 | R404A | 304                         | - |
| AIM 156F4  | -10 / -22 | 1500x600x850 | 275 | 230V - 50Hz | 95  | 0,68 | R404A | 430                         | - |
| AIM 157R3  | -2 / +8   | 1500x700x850 | 330 | 230V - 50Hz | 100 | 0,32 | R134A | 304                         | - |
| AIM 157R4  | -2 / +8   | 1500x700x850 | 330 | 230V - 50Hz | 100 | 0,32 | R134A | 430                         | - |
| AIM 157F3  | -10 / -22 | 1500x700x850 | 330 | 230V - 50Hz | 100 | 0,68 | R404A | 304                         | - |
| AIM 157F4  | -10 / -22 | 1500x700x850 | 330 | 230V - 50Hz | 100 | 0,68 | R404A | 430                         | - |

R290 İstenildiği takdirde fiyatlara %3 ilave edilir. / For R290 Refrigerant gas, price increase is 3%.

## OPSİYONLAR / OPTIONS

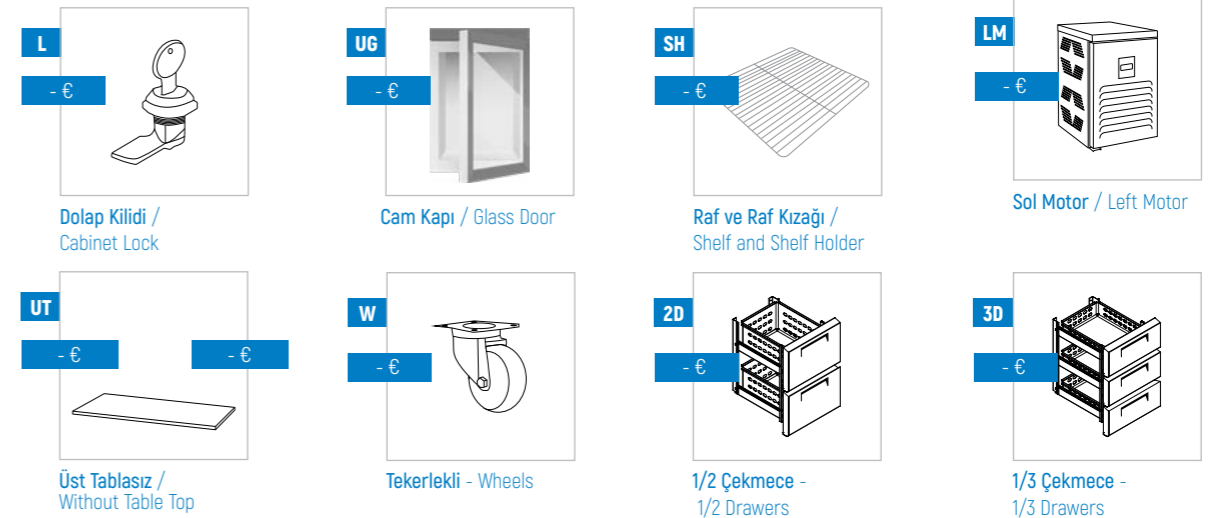

AIM

## AIM 156G-157G

TEZGAH TİP BUZDOLAPLARI - 2 CAM KAPILI  
COUNTER TYPE REFRIGERATORS - W/2 GLASS DOORS

## TEKNİK DETAYLAR / TECHNICAL DETAILS

TR

- Dış ortam sıcaklığı +43°C %65 nem oranı
- Eşit sıcaklık dağılımı için yeni tasarım
- Sıfır ODP enjekte 42 kg/m<sup>3</sup> çevre dostu poliüretan izolasyon
- Kolay okunur ekranlı dijital kontrol
- Ergonomik kapı ve kulpu sayesinde kolay açılma ve temizlik
- Patentli 'Icecool' soğutma sistemi ile mükemmel verim ve enerji sarfiyatı
- Sıcak gaz defrost sistemi
- Atık ısı geri kazanımlı kondanzasyon
- Tüm buzdolapların marine versiyonları mevcuttur.

EN

- Designed to operate in 43°C ambient %65 humidity
- New design for equal temperature distribution
- Zero ODP Injected 42 kg/m<sup>3</sup> Polyurethane Insulation
- Digital controller with easy read screen
- Ergonomic door and handle designed for ease of opening and cleaning
- Icecool refrigeration system designed to be most technologically advanced and energy efficient yet
- Hot gas defrost system
- Waste heat recovery condensate vaporiser system
- All refrigerators can be produced in marine version

AIM 156G-157G

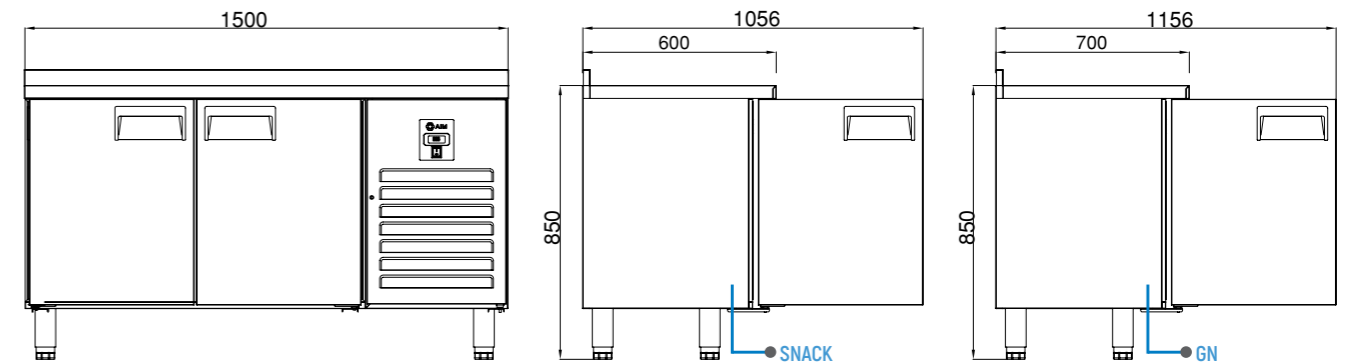

| KOD / CODE  | °C      | (MM)         | lit | 230V - 50Hz | kg  | (KW) | R134A | PASLANMAZ TİPİ<br>S.S. TYPE | € |
|-------------|---------|--------------|-----|-------------|-----|------|-------|-----------------------------|---|
| AIM 156R3-G | -2 / +8 | 1500x600x850 | 275 | 230V - 50Hz | 146 | 0,40 | R134A | 304                         | - |
| AIM 156R4-G | -2 / +8 | 1500x600x850 | 275 | 230V - 50Hz | 146 | 0,40 | R134A | 430                         | - |
| AIM 157R3-G | -2 / +8 | 1500x700x850 | 330 | 230V - 50Hz | 155 | 0,40 | R134A | 304                         | - |
| AIM 157R4-G | -2 / +8 | 1500x700x850 | 330 | 230V - 50Hz | 155 | 0,40 | R134A | 430                         | - |

R290 İstenildiği takdirde fiyatlara %3 ilave edilir. / For R290 Refrigerant gas, price increase is 3%.

## OPSİYONLAR / OPTIONS

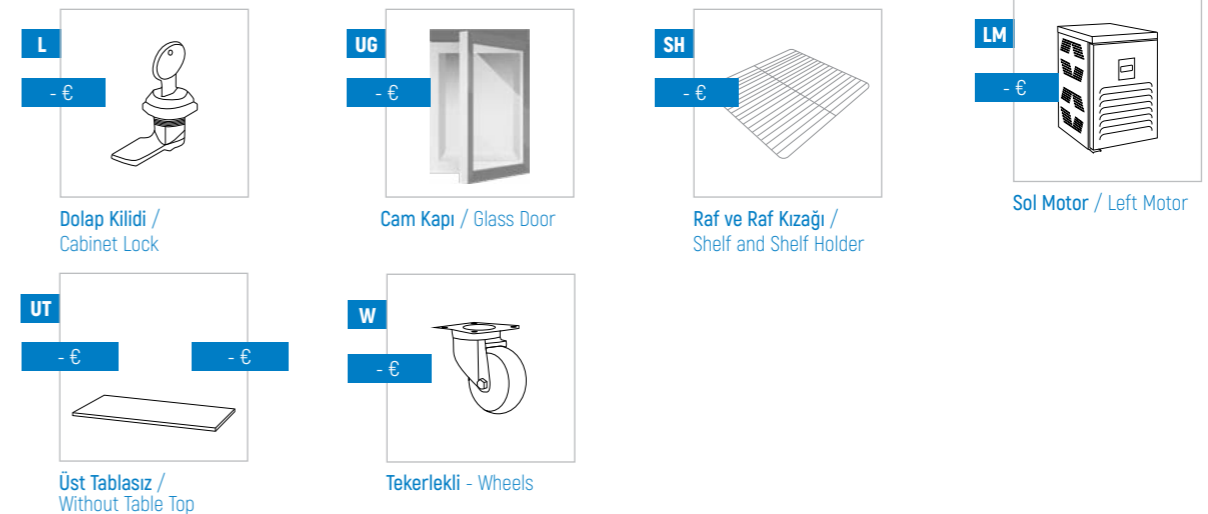

1/2 ÇEKMECE  
1/2 DRAWERS

## TEKNİK DETAYLAR / TECHNICAL DETAILS

## TR

- Dış ortam sıcaklığı +43°C %65 nem oranı
- Eşit sıcaklık dağılımı için yeni tasarım
- Sıfır ODP enjekte 42 kg/m<sup>3</sup> çevre dostu poliüretan izolasyon
- Kolay okunur ekranlı dijital kontrol
- Ergonomik kapı ve kulpu sayesinde kolay açılma ve temizlik
- Patentli 'Icecool' soğutma sistemi ile mükemmel verim ve enerji sarfiyatı
- Sıcak gaz defrost sistemi
- Atık ısı geri kazanımlı kondansasyon
- Tüm buzdolapların marine versiyonları mevcuttur.
- 1/2 Çekmece için; 1/1-150mm Gn kapasitesi.
- 1/3 Çekmece için; 1/1-100mm Gn kapasitesi.

## EN

- Designed to operate in 43°C ambient %65 humidity
- New design for equal temperature distribution
- Zero ODP Injected 42 kg/m<sup>3</sup> Polyurethane Insulation
- Digital controller with easy read screen
- Ergonomic door and handle designed for ease of opening and cleaning
- Icecool refrigeration system designed to be most technologically advanced and energy efficient yet
- Hot gas defrost system
- Waste heat recovery condensate vaporiser system
- All refrigerators can be produced in marine version
- For 1/2 drawers; 1/1-150mm Gn capacity
- For 1/3 drawers; 1/1-100mm Gn capacity

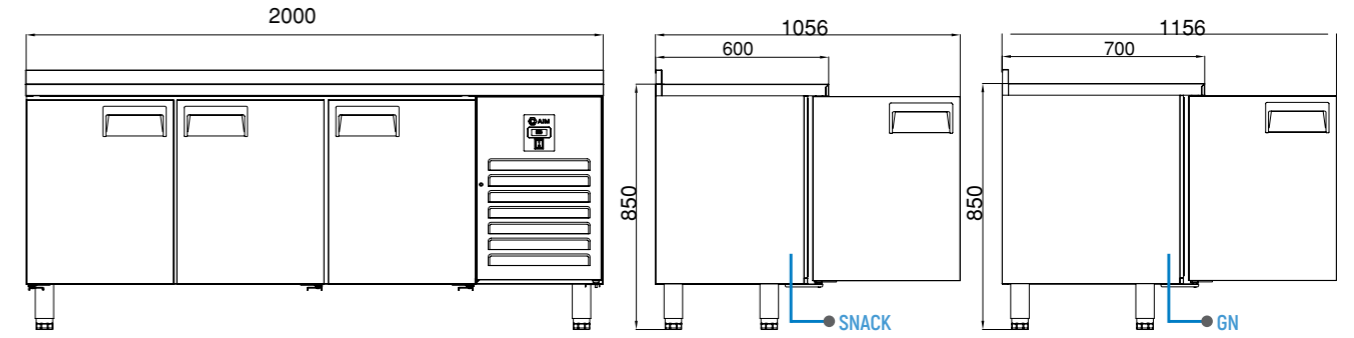

| KOD / CODE | °C        | (MM)         | it  | 230V - 50Hz | kg  | (KW) | R134A | PASLANMAZ TİPİ<br>S.S. TYPE | € |
|------------|-----------|--------------|-----|-------------|-----|------|-------|-----------------------------|---|
| AIM 206R3  | -2 / +8   | 2000x600x850 | 440 | 230V - 50Hz | 127 | 0,40 | R134A | 304                         | - |
| AIM 206R4  | -2 / +8   | 2000x600x850 | 440 | 230V - 50Hz | 127 | 0,40 | R134A | 430                         | - |
| AIM 206F3  | -10 / -22 | 2000x600x850 | 440 | 230V - 50Hz | 127 | 0,75 | R404A | 304                         | - |
| AIM 206F4  | -10 / -22 | 2000x600x850 | 440 | 230V - 50Hz | 127 | 0,75 | R404A | 430                         | - |
| AIM 207R3  | -2 / +8   | 2000x700x850 | 515 | 230V - 50Hz | 135 | 0,40 | R134A | 304                         | - |
| AIM 207R4  | -2 / +8   | 2000x700x850 | 515 | 230V - 50Hz | 135 | 0,40 | R134A | 430                         | - |
| AIM 207F3  | -10 / -22 | 2000x700x850 | 515 | 230V - 50Hz | 135 | 0,75 | R404A | 304                         | - |
| AIM 207F4  | -10 / -22 | 2000x700x850 | 515 | 230V - 50Hz | 135 | 0,75 | R404A | 430                         | - |

R290 R290 İstenildiği takdirde fiyatlara %3 ilave edilir. / For R290 Refrigerant gas, price increase is 3%.

## OPSİYONLAR / OPTIONS

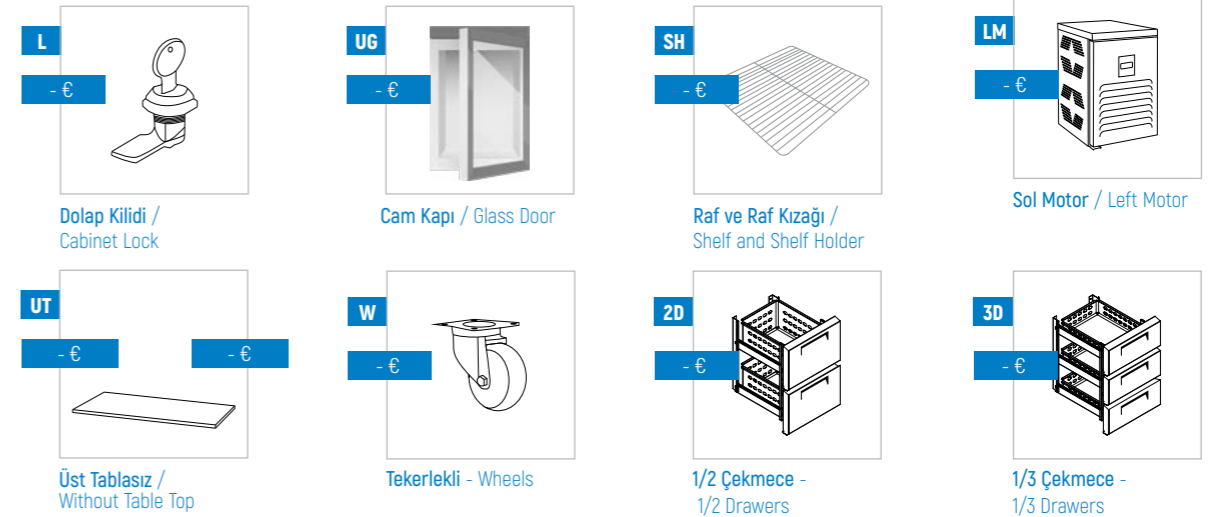

AIM

## AIM 206G-207G

TEZGAH TİP BUZDOLAPLARI - 3 CAM KAPILI  
COUNTER TYPE REFRIGERATORS - W/3 GLASS DOORS

## TEKNİK DETAYLAR / TECHNICAL DETAILS

TR

- Dış ortam sıcaklığı +43°C %65 nem oranı
- Eşit sıcaklık dağılımı için yeni tasarım
- Sıfır ODP enjekte 42 kg/m<sup>3</sup> çevre dostu poliüretan izolasyon
- Kolay okunur ekranlı dijital kontrol
- Ergonomik kapı ve kulpu sayesinde kolay açılma ve temizlik
- Patentli 'Icecool' soğutma sistemi ile mükemmel verim ve enerji sarfiyatı
- Sıcak gaz defrost sistemi
- Atık ısı geri kazanımlı kondansasyon
- Tüm buzdolapların marine versiyonları mevcuttur.

EN

- Designed to operate in 43°C ambient %65 humidity
- New design for equal temperature distribution
- Zero ODP Injected 42 kg/m<sup>3</sup> Polyurethane Insulation
- Digital controller with easy read screen
- Ergonomic door and handle designed for ease of opening and cleaning Icecool refrigeration system designed to be most technologically advanced and energy efficient yet
- Hot gas defrost system
- Waste heat recovery condensate vaporiser system
- All refrigerators can be produced in marine version

AIM 206G-207G

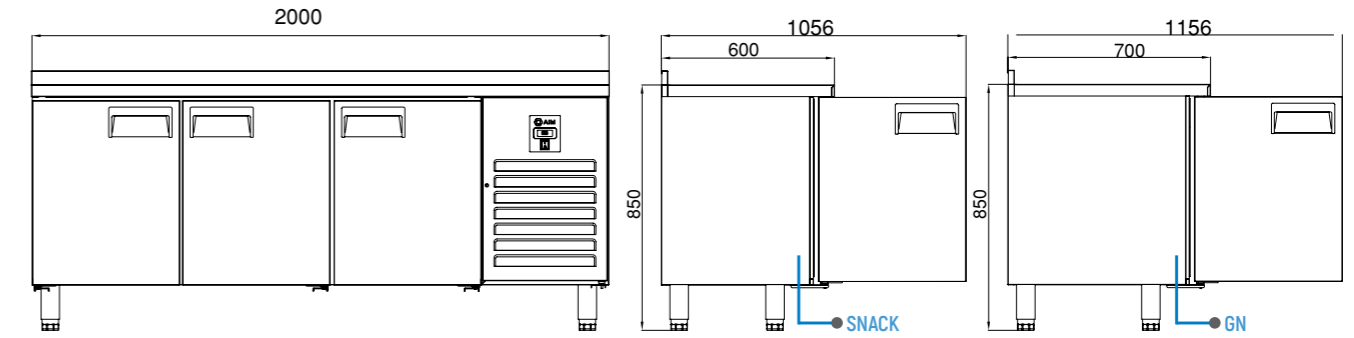

| KOD / CODE  | °C      | (MM)         | lit | 230V - 50Hz | kg  | (KW) | R134A | PASLANMAZ TİPİ<br>S.S. TYPE | € |
|-------------|---------|--------------|-----|-------------|-----|------|-------|-----------------------------|---|
| AIM 206R3-G | -2 / +8 | 2000x600x850 | 440 | 230V - 50Hz | 146 | 0,40 | R134A | 304                         | - |
| AIM 206R4-G | -2 / +8 | 2000x600x850 | 440 | 230V - 50Hz | 146 | 0,40 | R134A | 430                         | - |
| AIM 207R3-G | -2 / +8 | 2000x700x850 | 515 | 230V - 50Hz | 155 | 0,40 | R134A | 304                         | - |
| AIM 207R4-G | -2 / +8 | 2000x700x850 | 515 | 230V - 50Hz | 155 | 0,40 | R134A | 430                         | - |

R290 İstenildiği takdirde fiyatlara %3 ilave edilir. / For R290 Refrigerant gas, price increase is 3%.

## OPSİYONLAR / OPTIONS

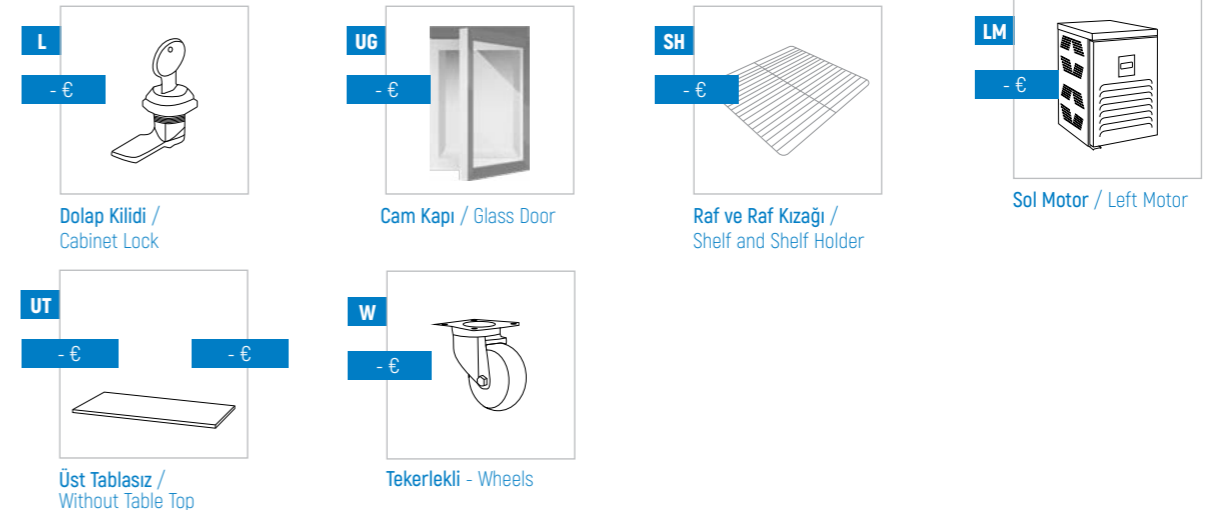

AIM

## AIM 256-257

TEZGAH TİP BUZDOLAPLARI - 4 KAPILI  
COUNTER TYPE REFRIGERATORS - W/4 DOORS

## TEKNİK DETAYLAR / TECHNICAL DETAILS

TR

- Dış ortam sıcaklığı +43°C %65 nem oranı
- Eşit sıcaklık dağılımı için yeni tasarım
- Sıfır ODP enjekte 42 kg/m<sup>3</sup> çevre dostu poliüretan izolasyon
- Kolay okunur ekranlı dijital kontrol
- Ergonomik kapı ve kulpu sayesinde kolay açılma ve temizlik
- Patentli 'Icecool' soğutma sistemi ile mükemmel verim ve enerji sarfiyatı
- Sıcak gaz defrost sistemi
- Atık ısı geri kazanımlı kondansasyon
- Tüm buzdolapların marine versiyonları mevcuttur.
- 1/2 Çekmece için; 1/1-150mm Gn kapasitesi.
- 1/3 Çekmece için; 1/1-100mm Gn kapasitesi.

EN

- Designed to operate in 43°C ambient %65 humidity
- New design for equal temperature distribution
- Zero ODP Injected 42 kg/m<sup>3</sup> Polyurethane Insulation
- Digital controller with easy read screen
- Ergonomic door and handle designed for ease of opening and cleaning
- Icecool refrigeration system designed to be most technologically advanced and energy efficient yet
- Hot gas defrost system
- Waste heat recovery condensate vaporiser system
- All refrigerators can be produced in marine version
- For 1/2 drawers; 1/1-150mm Gn capacity
- For 1/3 drawers; 1/1-100mm Gn capacity

AIM 256-257

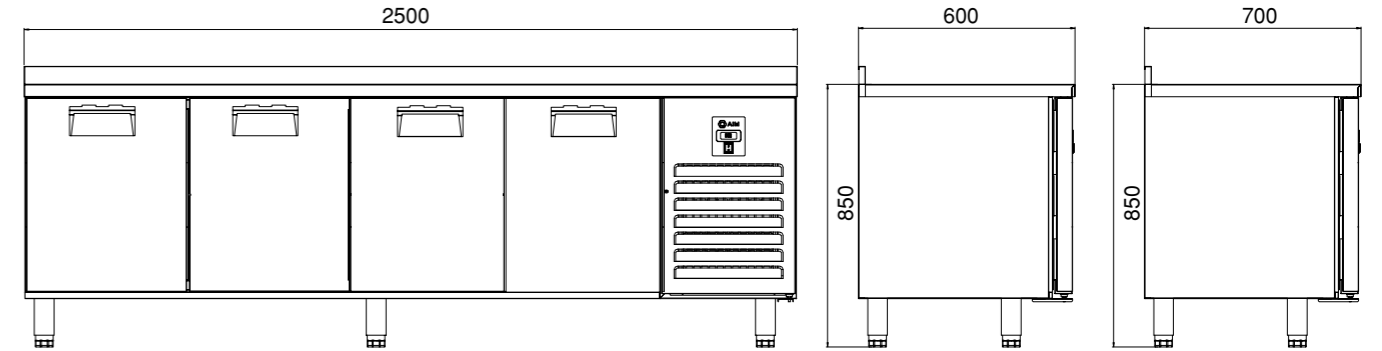

| KOD / CODE | °C        | (MM)         | It  | ⏻           | kg  | (KW) | ❄️    | PASLANMAZ TİPİ<br>S.S. TYPE | € |
|------------|-----------|--------------|-----|-------------|-----|------|-------|-----------------------------|---|
| AIM 256R3  | -2 / +8   | 2500x600x850 | 560 | 230V - 50Hz | 187 | 0,50 | R134A | 304                         | - |
| AIM 256R4  | -2 / +8   | 2500x600x850 | 560 | 230V - 50Hz | 187 | 0,50 | R134A | 430                         | - |
| AIM 256F3  | -10 / -22 | 2500x600x850 | 560 | 230V - 50Hz | 187 | 0,82 | R404A | 304                         | - |
| AIM 256F4  | -10 / -22 | 2500x600x850 | 560 | 230V - 50Hz | 187 | 0,82 | R404A | 430                         | - |
| AIM 257R3  | -2 / +8   | 2500x700x850 | 650 | 230V - 50Hz | 195 | 0,50 | R134A | 304                         | - |
| AIM 257R4  | -2 / +8   | 2500x700x850 | 650 | 230V - 50Hz | 195 | 0,50 | R134A | 430                         | - |
| AIM 257F3  | -10 / -22 | 2500x700x850 | 650 | 230V - 50Hz | 195 | 0,82 | R404A | 304                         | - |
| AIM 257F4  | -10 / -22 | 2500x700x850 | 650 | 230V - 50Hz | 195 | 0,82 | R404A | 430                         | - |

R290 İstenildiği takdirde fiyatlara %3 ilave edilir. / For R290 Refrigerant gas, price increase is 3%.

## OPSİYONLAR / OPTIONS

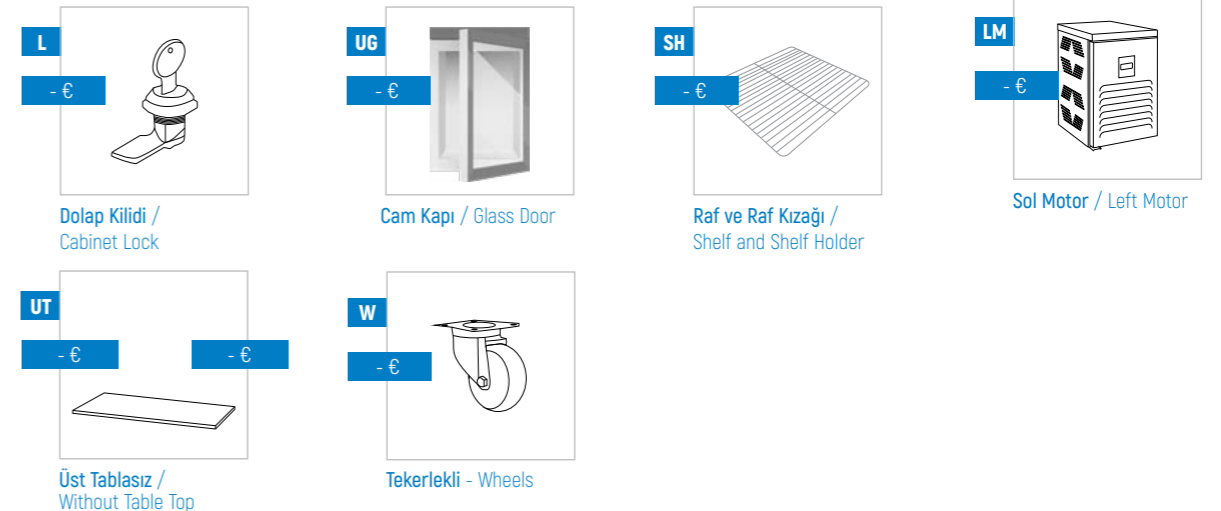

AIM

# AIM 256G-257G

TEZGAH TİP BUZDOLAPLARI - 4 CAM KAPILI  
COUNTER TYPE REFRIGERATORS - W/4 GLASS DOORS



## TEKNİK DETAYLAR / TECHNICAL DETAILS

TR

- Dış ortam sıcaklığı +43°C %65 nem oranı
- Eşit sıcaklık dağılımı için yeni tasarım
- Sıfır ODP enjekte 42 kg/m<sup>3</sup> çevre dostu poliüretan izolasyon
- Kolay okunur ekranlı dijital kontrol
- Ergonomik kapı ve kulpu sayesinde kolay açılma ve temizlik
- Patentli 'Icecool' soğutma sistemi ile mükemmel verim ve enerji sarfiyatı
- Sıcak gaz defrost sistemi
- Atık ısı geri kazanımlı kondansasyon
- Tüm buzdolapların marine versiyonları mevcuttur.

EN

- Designed to operate in 43°C ambient %65 humidity
- New design for equal temperature distribution
- Zero ODP Injected 42 kg/m<sup>3</sup> Polyurethane Insulation
- Digital controller with easy read screen
- Ergonomic door and handle designed for ease of opening and cleaning
- Icecool refrigeration system designed to be most technologically advanced and energy efficient yet
- Hot gas defrost system
- Waste heat recovery condensate vaporiser system
- All refrigerators can be produced in marine version

# AIM 256G-257G

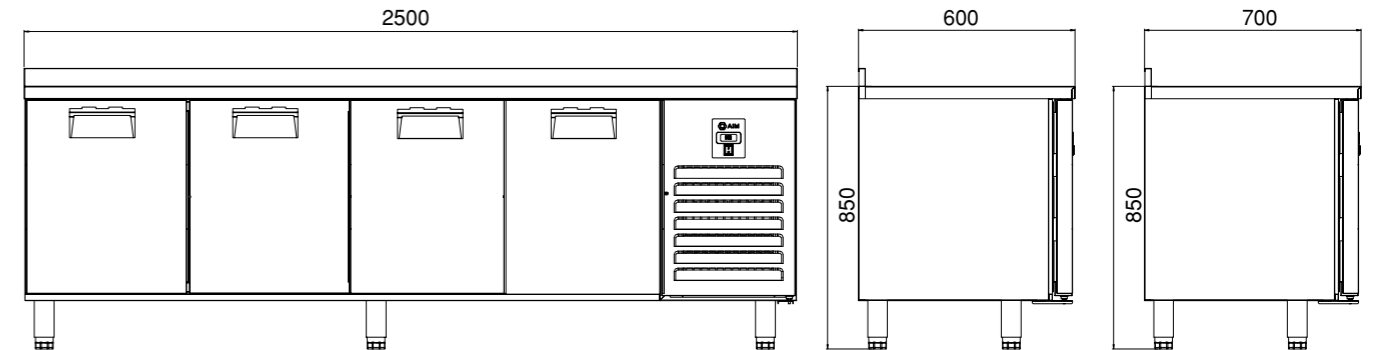

| KOD / CODE  | °C      | (MM)         | It  | Power       | kg  | (KW) | R134A | PASLANMAZ TİPİ<br>S.S. TYPE | € |
|-------------|---------|--------------|-----|-------------|-----|------|-------|-----------------------------|---|
| AIM 256R3-G | -2 / +8 | 2500x600x850 | 560 | 230V - 50Hz | 210 | 0,50 | R134A | 304                         | - |
| AIM 256R4-G | -2 / +8 | 2500x600x850 | 560 | 230V - 50Hz | 210 | 0,50 | R134A | 430                         | - |
| AIM 257R3-G | -2 / +8 | 2500x700x850 | 650 | 230V - 50Hz | 224 | 0,50 | R134A | 304                         | - |
| AIM 257R4-G | -2 / +8 | 2500x700x850 | 650 | 230V - 50Hz | 224 | 0,50 | R134A | 430                         | - |

R290 İstenildiği takdirde fiyatlara %3 ilave edilir. / For R290 Refrigerant gas, price increase is 3%.

## OPSIYONLAR / OPTIONS

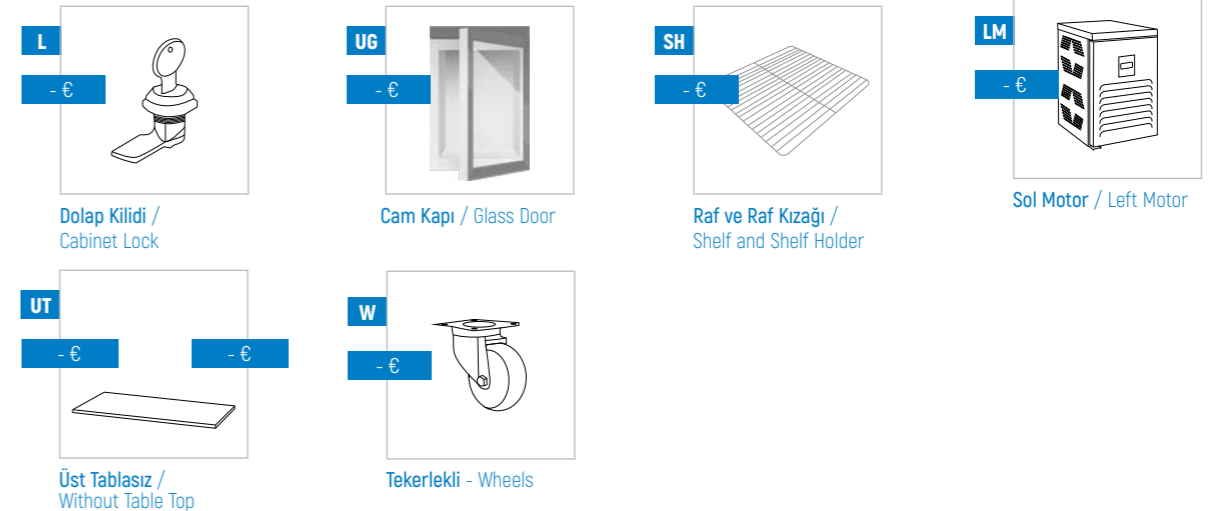

AIM

## AIM 126-127

TEZGAH TİP BUZDOLAPLARI - KISA MODEL  
COUNTER TYPE REFRIGERATORS - SHORT

## TEKNİK DETAYLAR / TECHNICAL DETAILS

TR

- Dış ortam sıcaklığı +43°C %65 nem oranı
- Eşit sıcaklık dağılımı için yeni tasarım
- Sıfır ODP enjekte 42 kg/m<sup>3</sup> çevre dostu poliüretan izolasyon
- Kolay okunur ekranlı dijital kontrol
- Ergonomik kapı ve kulpu sayesinde kolay açılma ve temizlik
- Patentli 'Icecool' soğutma sistemi ile mükemmel verim ve enerji sarfiyatı
- Sıcak gaz defrost sistemi
- Atık ısı geri kazanımlı kondansasyon
- Tüm buzdolapların marine versiyonları mevcuttur.
- 1/2 Çekmece için; 1/1-150mm Gn kapasitesi.
- 1/3 Çekmece için; 1/1-100mm Gn kapasitesi.

EN

- Designed to operate in 43°C ambient %65 humidity
- New design for equal temperature distribution
- Zero ODP Injected 42 kg/m<sup>3</sup> Polyurethane Insulation
- Digital controller with easy read screen
- Ergonomic door and handle designed for ease of opening and cleaning
- Icecool refrigeration system designed to be most technologically advanced and energy efficient yet
- Hot gas defrost system
- Waste heat recovery condensate vaporiser system
- All refrigerators can be produced in marine version
- For 1/2 drawers; 1/1-150mm Gn capacity
- For 1/3 drawers; 1/1-100mm Gn capacity

AIM 126-127

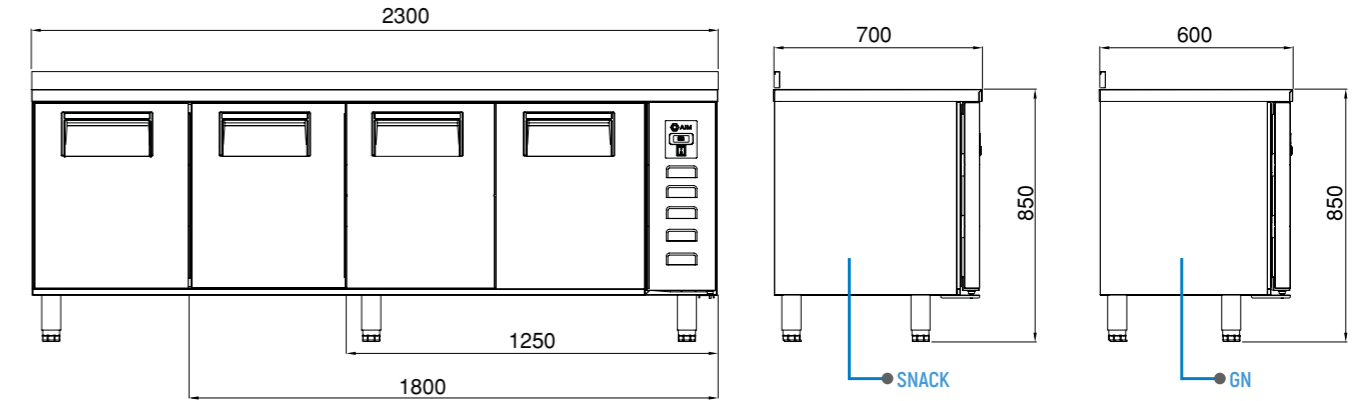

| KOD / CODE | °C      | (MM)         | lit | 230V - 50Hz | kg  | (KW) | R134A | PASLANMAZ TİPİ<br>S.S. TYPE | € |
|------------|---------|--------------|-----|-------------|-----|------|-------|-----------------------------|---|
| AIM 126R3  | -2 / +8 | 1250x600x850 | 275 | 230V - 50Hz | 95  | 0,32 | R134A | 304                         | - |
| AIM 126R4  | -2 / +8 | 1250x600x850 | 275 | 230V - 50Hz | 95  | 0,32 | R134A | 430                         | - |
| AIM 127R3  | -2 / +8 | 1250x700x850 | 330 | 230V - 50Hz | 100 | 0,32 | R134A | 304                         | - |
| AIM 127R4  | -2 / +8 | 1250x700x850 | 330 | 230V - 50Hz | 100 | 0,32 | R134A | 430                         | - |
| AIM 186R3  | -2 / +8 | 1800x600x850 | 440 | 230V - 50Hz | 127 | 0,34 | R134A | 304                         | - |
| AIM 186R4  | -2 / +8 | 1800x600x850 | 440 | 230V - 50Hz | 127 | 0,34 | R134A | 430                         | - |
| AIM 187R3  | -2 / +8 | 1800x700x850 | 515 | 230V - 50Hz | 135 | 0,34 | R134A | 304                         | - |
| AIM 187R4  | -2 / +8 | 1800x700x850 | 515 | 230V - 50Hz | 135 | 0,34 | R134A | 430                         | - |
| AIM 236R3  | -2 / +8 | 2300x600x850 | 560 | 230V - 50Hz | 187 | 0,50 | R134A | 304                         | - |
| AIM 236R4  | -2 / +8 | 2300x600x850 | 560 | 230V - 50Hz | 187 | 0,50 | R134A | 430                         | - |
| AIM 237R3  | -2 / +8 | 2300x700x850 | 650 | 230V - 50Hz | 195 | 0,50 | R134A | 304                         | - |
| AIM 237R4  | -2 / +8 | 2300x700x850 | 650 | 230V - 50Hz | 195 | 0,50 | R134A | 430                         | - |

R290 İstenildiği takdirde fiyatlara %3 ilave edilir. / For R290 Refrigerant gas, price increase is 3%.

## OPSİYONLAR / OPTIONS

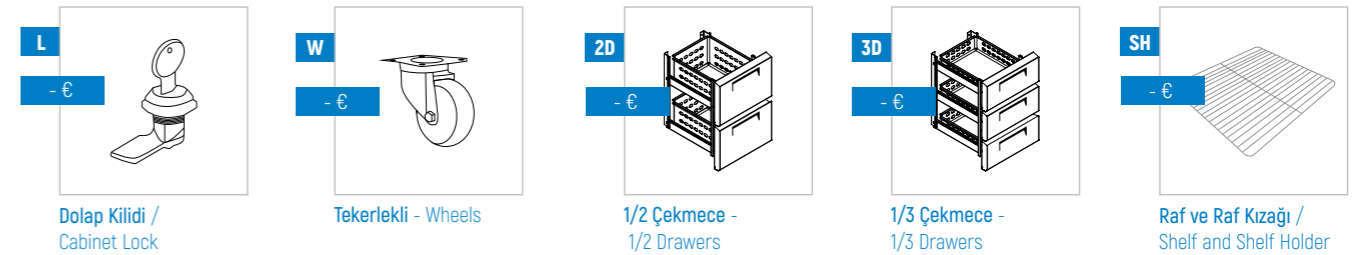

|                                  | 2 KAPILI / 2 DOORS | 3 KAPILI / 3 DOORS | 4 KAPILI / 4 DOORS |
|----------------------------------|--------------------|--------------------|--------------------|
| ÜST TABLASIZ / WITHOUT TABLE TOP | -€<br>-€           | -€<br>-€           | -€<br>-€           |

AIM

## AIM 156S-157S

TEZGAH TİP EYYELİ BUZDOLABI - EYYELİ  
COUNTER TYPE REFRIGERATORS - WITH SINK UNIT

| KOD / CODE  | °C      | (MM)         | lt  | 230V - 50Hz | kg  | (kW) | R134A | PASLANMAZ TİPİ<br>S.S. TYPE | € |
|-------------|---------|--------------|-----|-------------|-----|------|-------|-----------------------------|---|
| AIM 156R3-S | -2 / +8 | 1500x600x850 | 275 | 230V - 50Hz | 95  | 0,32 | R134A | 304                         | - |
| AIM 156R4-S | -2 / +8 | 1500x600x850 | 275 | 230V - 50Hz | 95  | 0,32 | R134A | 430                         | - |
| AIM 157R3-S | -2 / +8 | 1500x700x850 | 330 | 230V - 50Hz | 100 | 0,32 | R134A | 304                         | - |
| AIM 157R4-S | -2 / +8 | 1500x700x850 | 330 | 230V - 50Hz | 100 | 0,32 | R134A | 430                         | - |
| AIM 206R3-S | -2 / +8 | 2000x600x850 | 515 | 230V - 50Hz | 127 | 0,36 | R134A | 304                         | - |
| AIM 206R4-S | -2 / +8 | 2000x600x850 | 515 | 230V - 50Hz | 127 | 0,36 | R134A | 430                         | - |
| AIM 207R3-S | -2 / +8 | 2000x700x850 | 515 | 230V - 50Hz | 135 | 0,36 | R134A | 304                         | - |
| AIM 207R4-S | -2 / +8 | 2000x700x850 | 515 | 230V - 50Hz | 135 | 0,36 | R134A | 430                         | - |
| AIM 256R3-S | -2 / +8 | 2500x600x850 | 560 | 230V - 50Hz | 187 | 0,63 | R134A | 304                         | - |
| AIM 256R4-S | -2 / +8 | 2500x600x850 | 560 | 230V - 50Hz | 187 | 0,63 | R134A | 430                         | - |
| AIM 257R3-S | -2 / +8 | 2500x700x850 | 650 | 230V - 50Hz | 195 | 0,63 | R134A | 304                         | - |
| AIM 257R4-S | -2 / +8 | 2500x700x850 | 650 | 230V - 50Hz | 195 | 0,63 | R134A | 430                         | - |

R290 İstenildiği takdirde fiyatlara %3 ilave edilir. / For R290 Refrigerant gas, price increase is 3%.

## TEKNİK DETAYLAR / TECHNICAL DETAILS

TR

- Dış ortam sıcaklığı +43°C %65 nem oranı
- Eşit sıcaklık dağılımı için yeni tasarım
- Sıfır ODP enjekte 42 kg/m<sup>3</sup> çevre dostu poliüretan izolasyon
- Kolay okunur ekranlı dijital kontrol
- Ergonomik kapı ve kulpu sayesinde kolay açılma ve temizlik
- Patentli 'Icecool' soğutma sistemi ile mükemmel verim ve enerji sarfiyatı
- Sıcak gaz defrost sistemi
- Atık ısı geri kazanımlı kondansasyon
- Tüm buzdolapların marine versiyonları mevcuttur.
- 1/2 Çekmece için; 1/1-150mm Gn kapasitesi.
- 1/3 Çekmece için; 1/1-100mm Gn kapasitesi.

EN

- Designed to operate in 43°C ambient %65 humidity
- New design for equal temperature distribution
- Zero ODP Injected 42 kg/m<sup>3</sup> Polyurethane Insulation
- Digital controller with easy read screen
- Ergonomic door and handle designed for ease of opening and cleaning
- Icecool refrigeration system designed to be most technologically advanced and energy efficient yet
- Hot gas defrost system
- Waste heat recovery condensate vaporiser system
- All refrigerators can be produced in marine version
- For 1/2 drawers; 1/1-150mm Gn capacity
- For 1/3 drawers; 1/1-100mm Gn capacity

AIM 156S-157S

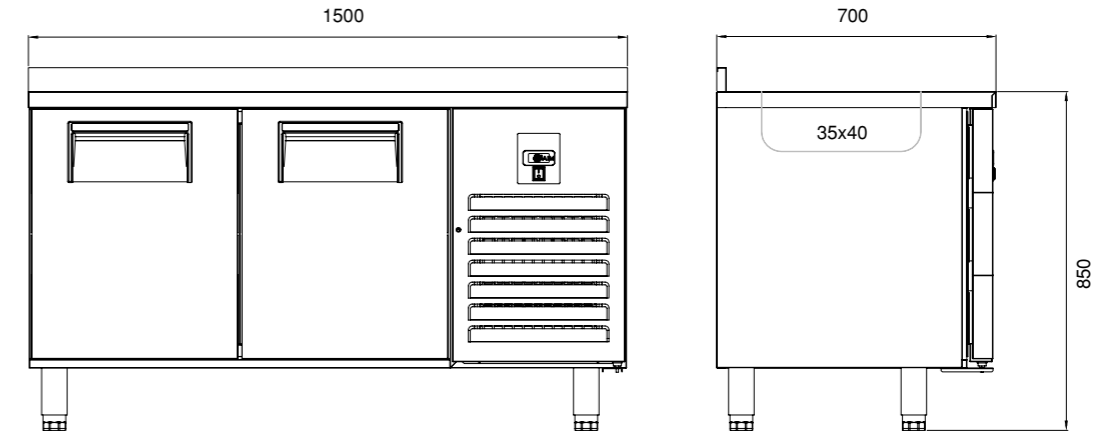

## OPSİYONLAR / OPTIONS

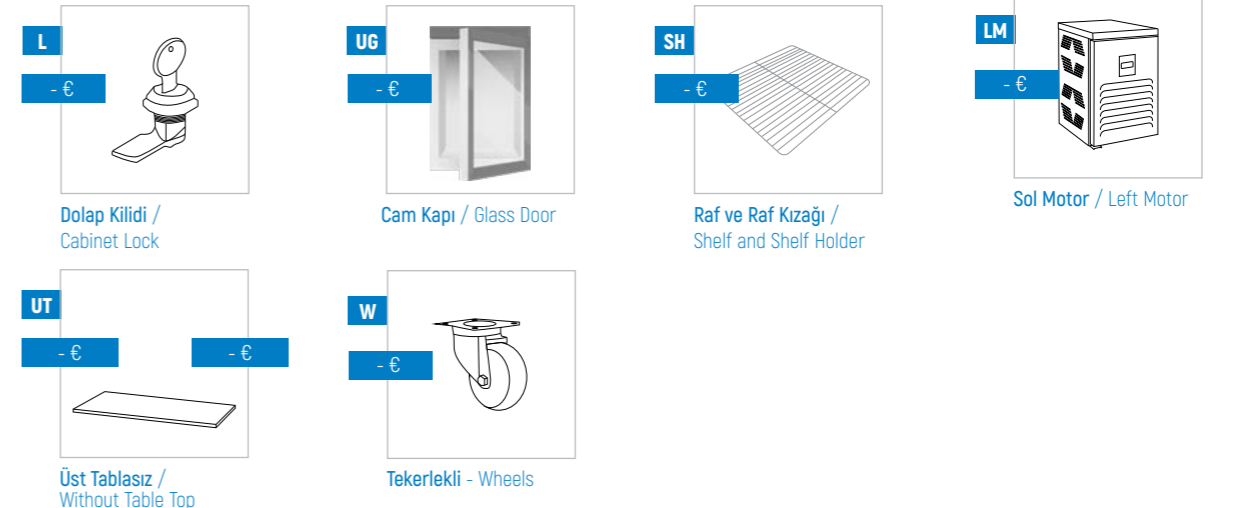

# DİK TİP SOĞUTUCU SERİSİ

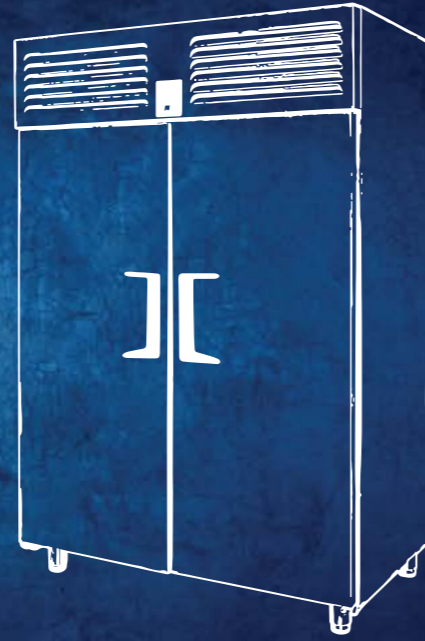

## VERTICAL TYPE SERIES



### YENİ KONDENSER SİSTEMİ NEW CONDENSER SYSTEM



CLASSIC

Temizlik gerektirmeyen kondenser  
Stayclear Condenser



AIMCLEAR



### ENERJİ TASARRUFU SAVING ENERGY

Düşük enerji tüketimi sağlayan çevre dostu  
HFC içermeyen poliüretan izolasyon  
Eco friendly, HFC - free polyurethane insulation  
providing low energy consumption

### KUSURSUZ SOĞUTMA SİSTEMİ PERFECT COOLING SYSTEM

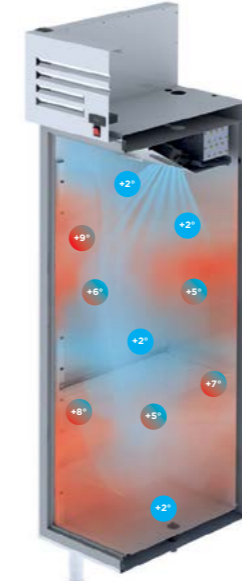

CLASSIC

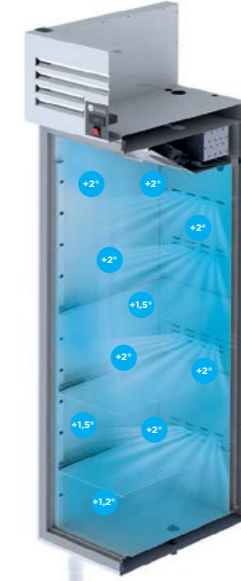

AIMCE

Arka sac sayesinde her rafta homojen ısı dağılımı  
Homogeneous heat distribution on each shelf thanks to custom design rear sheet

### SICAK GAZ DEFOST İLE KARLANMAYAN EVAPARATÖR EVAPARATOR DOES NOT SNOW THROUGH HOT GAS DEFROST



CLASSIC

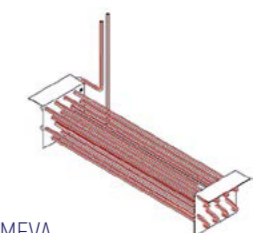

AIMEVA

AIM

AIM 40

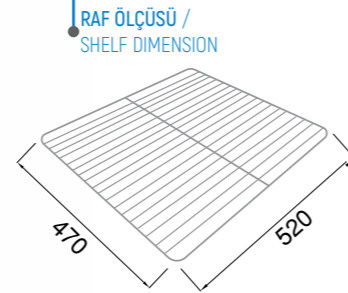
DİKEY TİP BUZDOLAPLARI - 1 KAPILI - SLİM TİP  
VERTICAL TYPE REFRIGERATORS - W/1 DOOR - SLİM TYPE

## TEKNİK DETAYLAR / TECHNICAL DETAILS

TR

- Dış ortam sıcaklığı +43°C %65 nem oranı
- Eşit sıcaklık dağılımı için yeni tasarım
- Sıfır ODP enjekte 42 kg/m<sup>3</sup> çevre dostu poliüretan izolasyon
- Kolay okunur ekranlı dijital kontrol
- Ergonomik kapı ve kulpu sayesinde kolay açılma ve temizlik
- Patentli 'Icecool' soğutma sistemi ile mükemmel verim ve enerji sarfiyatı
- Sıcak gaz defrost sistemi
- Atık ısı geri kazanımlı kondansasyon
- Tüm buzdolapların marine versiyonları mevcuttur.
- Marine versiyonları 'Icecool marine' sistemi, marine ayak ve raflar içerir.

EN

- Designed to operate in 43°C ambient %65 humidity
- New design for equal temperature distribution
- Zero ODP Injected 42 kg/m<sup>3</sup> Polyurethane Insulation
- Digital controller with easy read screen
- Ergonomic door and handle designed for ease of opening and cleaning
- Icecool refrigeration system designed to be most technologically advanced and energy efficient yet
- Hot gas defrost system
- Waste heat recovery condensate vaporiser system
- All refrigerators can be produced in marine version
- Marine version includes 'Icecool marine' system, legs and shelves

AIM 40

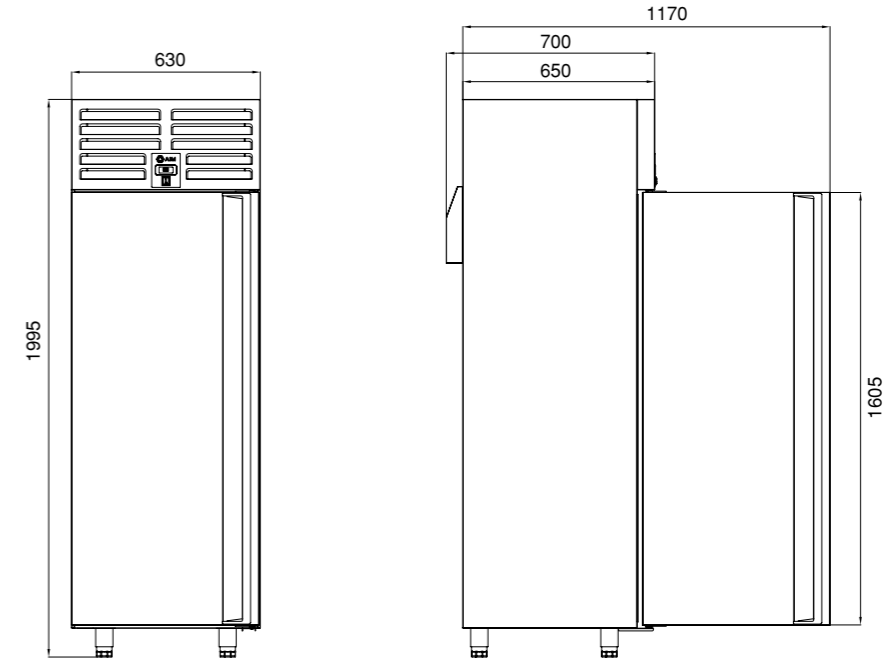

| KOD / CODE | °C        | (MM)         | it  | 230V - 50Hz | kg  | (KW) | R     | PASLANMAZ TİPİ<br>S.S. TYPE | € |
|------------|-----------|--------------|-----|-------------|-----|------|-------|-----------------------------|---|
| AIM 40SR3  | -2 / +8   | 630x650x1995 | 400 | 230V - 50Hz | 104 | 0,32 | R134A | 304                         | - |
| AIM 40SR4  | -2 / +8   | 630x650x1995 | 400 | 230V - 50Hz | 104 | 0,32 | R134A | 430                         | - |
| AIM 40SF3  | -10 / -22 | 630x650x1995 | 400 | 230V - 50Hz | 104 | 0,70 | R404A | 304                         | - |
| AIM 40SF4  | -10 / -22 | 630x650x1995 | 400 | 230V - 50Hz | 104 | 0,70 | R404A | 430                         | - |

R290 İstenildiği takdirde fiyatlara %3 ilave edilir. / For R290 Refrigerant gas, price increase is 3%.

## OPSİYONLAR / OPTIONS

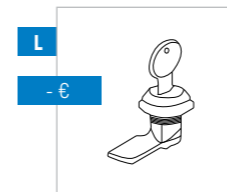
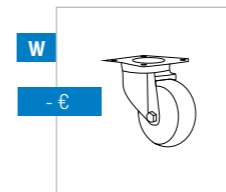
Dolap Kilidi /  
Cabinet Lock

Tekerekli - Wheels

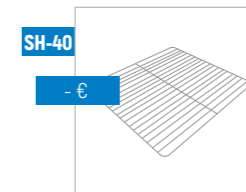
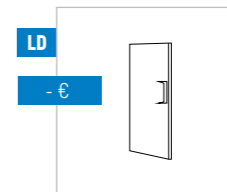
Raf ve Raf Kızağı /  
Shelf and Shelf Holder

Sol Kapı / Left Door

AIM

AIM 70

DİKEY TİP BUZDOLAPLARI - 1 KAPILI  
VERTICAL TYPE REFRIGERATORS - W/1 DOOR

## TEKNİK DETAYLAR / TECHNICAL DETAILS

TR

- Dış ortam sıcaklığı +43°C %65 nem oranı
- Eşit sıcaklık dağılımı için yeni tasarım
- Sıfır ODP enjekte 42 kg/m<sup>3</sup> çevre dostu poliüretan izolasyon
- Kolay okunur ekranlı dijital kontrol
- Ergonomik kapı ve kulpu sayesinde kolay açılma ve temizlik
- Patentli 'Icecool' soğutma sistemi ile mükemmel verim ve enerji sarfiyatı
- Sıcak gaz defrost sistemi
- Atık ısı geri kazanımlı kondansasyon
- Tüm buzdolapların marine versiyonları mevcuttur.
- Marine versiyonları 'Icecool marine' sistemi, marine ayak ve raflar içerir.

EN

- Designed to operate in 43°C ambient %65 humidity
- New design for equal temperature distribution
- Zero ODP Injected 42 kg/m<sup>3</sup> Polyurethane Insulation
- Digital controller with easy read screen
- Ergonomic door and handle designed for ease of opening and cleaning
- Icecool refrigeration system designed to be most technologically advanced and energy efficient yet
- Hot gas defrost system
- Waste heat recovery condensate vaporiser system
- All refrigerators can be produced in marine version
- Marine version includes 'Icecool marine' system, legs and shelves

AIM 70

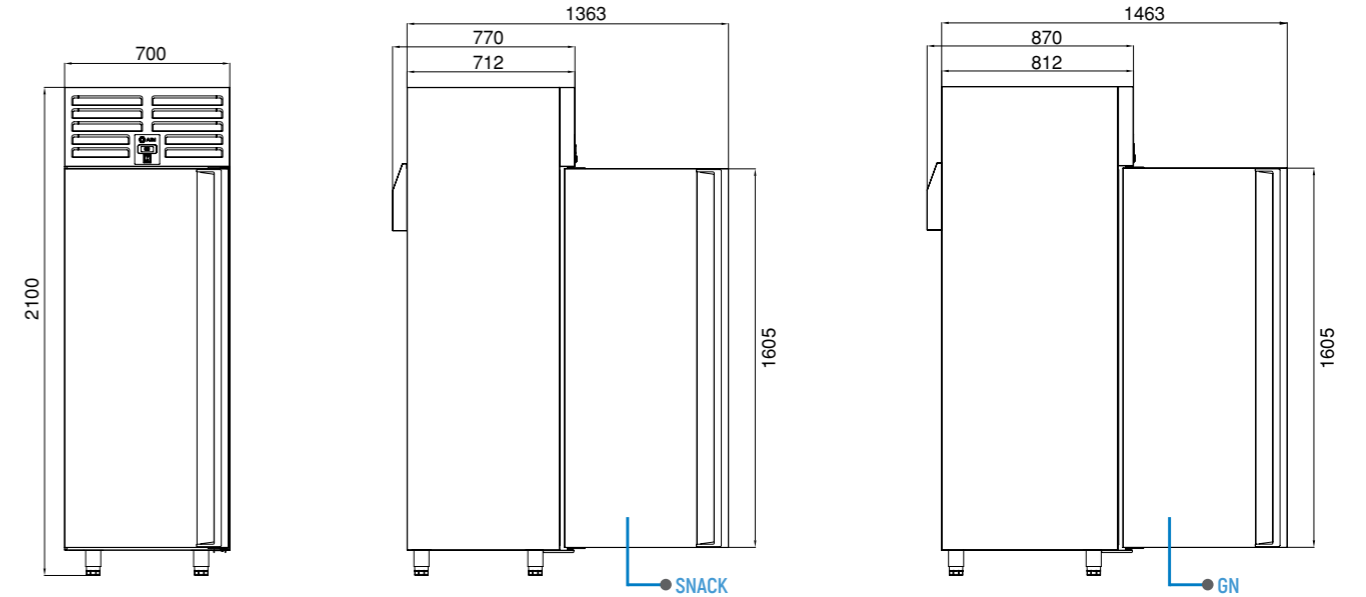

| KOD / CODE | °C        | (MM)         | lt  | 230V - 50Hz | kg  | (KW) | R134A / R404A | PASLANMAZ TİPİ / S.S. TYPE | € |
|------------|-----------|--------------|-----|-------------|-----|------|---------------|----------------------------|---|
| AIM 70SR3  | -2 / +8   | 700x770x2100 | 520 | 230V - 50Hz | 116 | 0,32 | R134A         | 304                        | - |
| AIM 70SR4  | -2 / +8   | 700x770x2100 | 520 | 230V - 50Hz | 116 | 0,32 | R134A         | 430                        | - |
| AIM 70SF3  | -10 / -22 | 700x770x2100 | 520 | 230V - 50Hz | 116 | 0,70 | R404A         | 304                        | - |
| AIM 70SF4  | -10 / -22 | 700x770x2100 | 520 | 230V - 50Hz | 116 | 0,70 | R404A         | 430                        | - |
| AIM 70GR3  | -2 / +8   | 700x870x2100 | 610 | 230V - 50Hz | 124 | 0,32 | R134A         | 304                        | - |
| AIM 70GR4  | -2 / +8   | 700x870x2100 | 610 | 230V - 50Hz | 124 | 0,32 | R134A         | 430                        | - |
| AIM 70GF3  | -10 / -22 | 700x870x2100 | 610 | 230V - 50Hz | 124 | 0,70 | R404A         | 304                        | - |
| AIM 70GF4  | -10 / -22 | 700x870x2100 | 610 | 230V - 50Hz | 124 | 0,70 | R404A         | 430                        | - |

R290 istenildiği takdirde fiyatlara %3 ilave edilir. / For R290 Refrigerant gas, price increase is 3%.

## OPSİYONLAR / OPTIONS

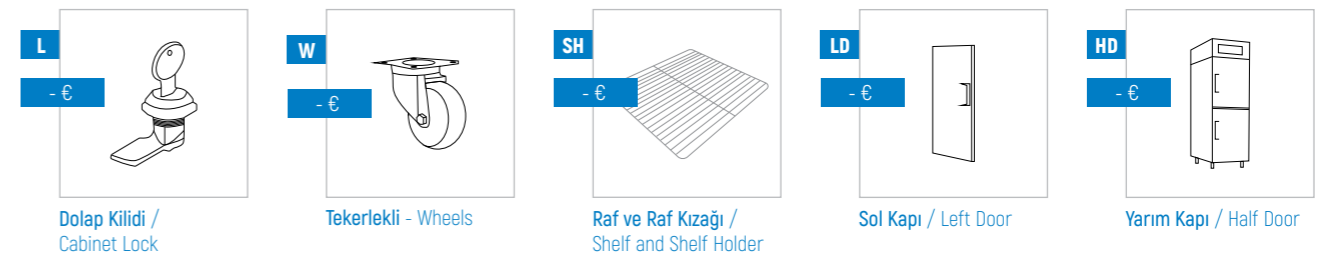

AIM

AIM 70G

DİKEY TİP BUZDOLAPLARI - 1 CAM KAPILI  
VERTICAL TYPE REFRIGERATORS - W/1 GLASS DOOR

## TEKNİK DETAYLAR / TECHNICAL DETAILS

TR

- Dış ortam sıcaklığı +43°C %65 nem oranı
- Eşit sıcaklık dağılımı için yeni tasarım
- Sıfır ODP enjekte 42 kg/m<sup>3</sup> çevre dostu poliüretan izolasyon
- Kolay okunur ekranlı dijital kontrol
- Ergonomik kapı ve kulpu sayesinde kolay açılma ve temizlik
- Patentli 'Icecool' soğutma sistemi ile mükemmel verim ve enerji sarfiyatı
- Sıcak gaz defrost sistemi
- Atık ısı geri kazanımlı kondansasyon
- Tüm buzdolapların marine versiyonları mevcuttur.
- Marine versiyonları 'Icecool marine' sistemi, marine ayak ve raflar içerir.

EN

- Designed to operate in 43°C ambient %65 humidity
- New design for equal temperature distribution
- Zero ODP Injected 42 kg/m<sup>3</sup> Polyurethane Insulation
- Digital controller with easy read screen
- Ergonomic door and handle designed for ease of opening and cleaning
- Icecool refrigeration system designed to be most technologically advanced and energy efficient yet
- Hot gas defrost system
- Waste heat recovery condensate vaporiser system
- All refrigerators can be produced in marine version
- Marine version includes 'Icecool marine' system, legs and shelves

AIM 70G

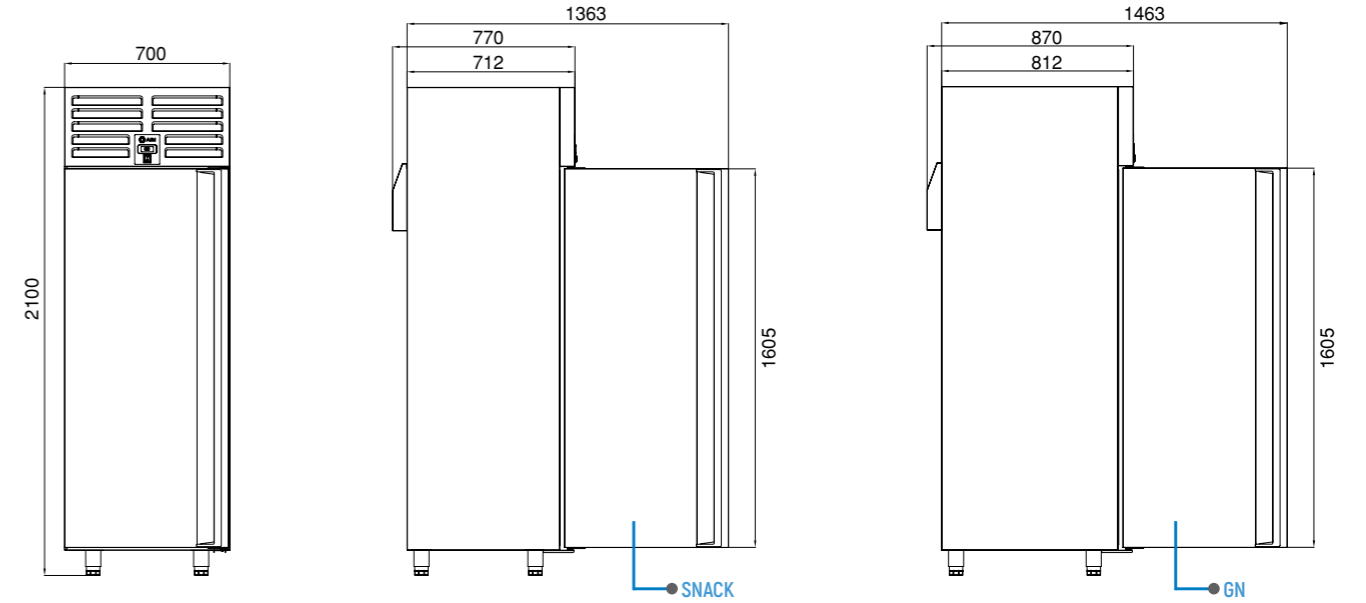

| KOD / CODE  | °C        | mm           | lt  | Power       | kg  | (KW) | Compressor | PASLANMAZ TİPİ<br>S.S. TYPE | € |
|-------------|-----------|--------------|-----|-------------|-----|------|------------|-----------------------------|---|
| AIM 70SR3-G | -2 / +8   | 700x770x2100 | 520 | 230V - 50Hz | 126 | 0,32 | R134A      | 304                         | - |
| AIM 70SR4-G | -2 / +8   | 700x770x2100 | 520 | 230V - 50Hz | 126 | 0,32 | R134A      | 430                         | - |
| AIM 70SF3-G | -10 / -22 | 700x770x2100 | 520 | 230V - 50Hz | 126 | 0,70 | R404A      | 304                         | - |
| AIM 70SF4-G | -10 / -22 | 700x770x2100 | 520 | 230V - 50Hz | 126 | 0,70 | R404A      | 430                         | - |
| AIM 70GR3-G | -2 / +8   | 700x870x2100 | 610 | 230V - 50Hz | 133 | 0,32 | R134A      | 304                         | - |
| AIM 70GR4-G | -2 / +8   | 700x870x2100 | 610 | 230V - 50Hz | 133 | 0,32 | R134A      | 430                         | - |
| AIM 70GF3-G | -10 / -22 | 700x870x2100 | 610 | 230V - 50Hz | 133 | 0,70 | R404A      | 304                         | - |
| AIM 70GF4-G | -10 / -22 | 700x870x2100 | 610 | 230V - 50Hz | 133 | 0,70 | R404A      | 430                         | - |

R290 İstenildiği takdirde fiyatlara %3 ilave edilir. / For R290 Refrigerant gas, price increase is 3%.

## OPSİYONLAR / OPTIONS

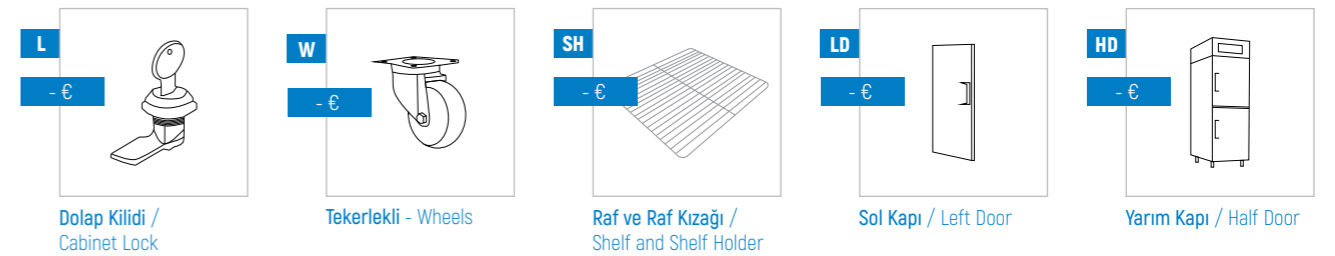

AIM

AIM 14

DİKEY TİP BUZDOLAPLARI - 2 KAPILI  
VERTICAL TYPE REFRIGERATORS - W/2 DOORS

## TEKNİK DETAYLAR / TECHNICAL DETAILS

TR

- Dış ortam sıcaklığı +43°C %65 nem oranı
- Eşit sıcaklık dağılımı için yeni tasarım
- Sıfır ODP enjekte 42 kg/m<sup>3</sup> çevre dostu poliüretan izolasyon
- Kolay okunur ekranlı dijital kontrol
- Ergonomik kapı ve kulpu sayesinde kolay açılma ve temizlik
- Patentli 'Icecool' soğutma sistemi ile mükemmel verim ve enerji sarfiyatı
- Sıcak gaz defrost sistemi
- Atık ısı geri kazanımlı kondansasyon
- Tüm buzdolapların marine versiyonları mevcuttur.
- Marine versiyonları 'Icecool marine' sistemi, marine ayak ve raflar içerir.

EN

- Designed to operate in 43°C ambient %65 humidity
- New design for equal temperature distribution
- Zero ODP Injected 42 kg/m<sup>3</sup> Polyurethane Insulation
- Digital controller with easy read screen
- Ergonomic door and handle designed for ease of opening and cleaning
- Icecool refrigeration system designed to be most technologically advanced and energy efficient yet
- Hot gas defrost system
- Waste heat recovery condensate vaporiser system
- All refrigerators can be produced in marine version
- Marine version includes 'Icecool marine' system, legs and shelves

AIM 14

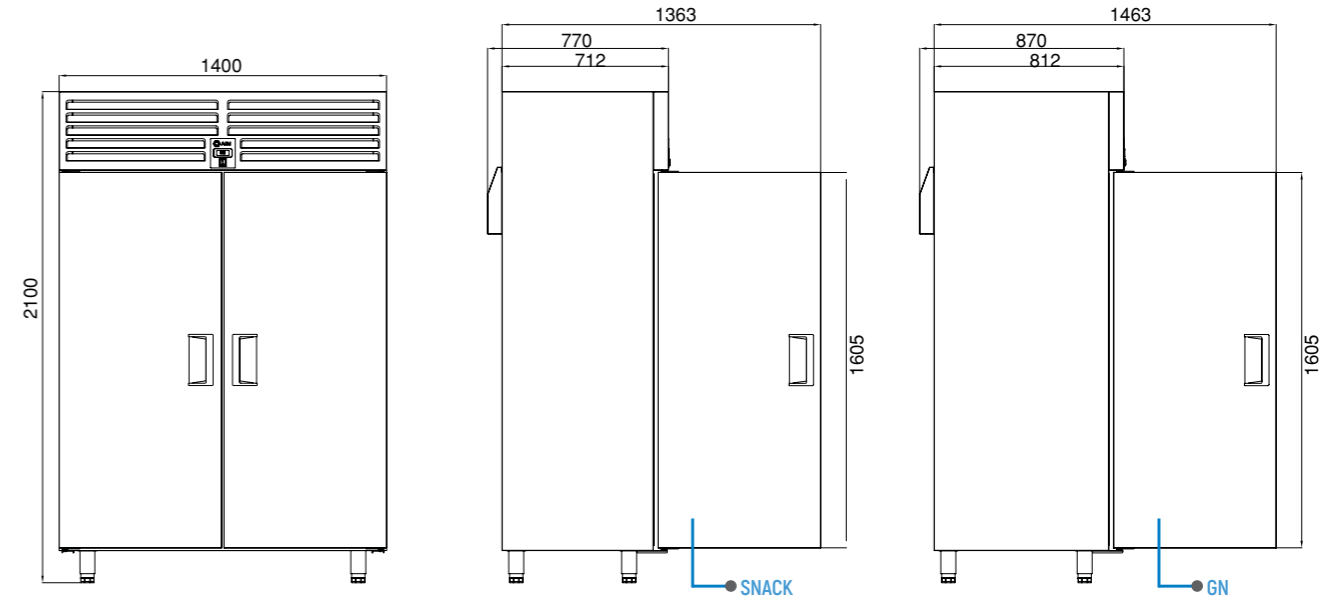

| KOD / CODE | °C        | (MM)          | lt   | 230V - 50Hz | kg  | (KW) | R134A / R404A | PASLANMAZ TİPİ<br>S.S. TYPE | € |
|------------|-----------|---------------|------|-------------|-----|------|---------------|-----------------------------|---|
| AIM 14SR3  | -2 / +8   | 1400x770x2100 | 1150 | 230V - 50Hz | 175 | 0,76 | R134A         | 304                         | - |
| AIM 14SR4  | -2 / +8   | 1400x770x2100 | 1150 | 230V - 50Hz | 175 | 0,76 | R134A         | 430                         | - |
| AIM 14SF3  | -10 / -22 | 1400x770x2100 | 1150 | 230V - 50Hz | 175 | 0,98 | R404A         | 304                         | - |
| AIM 14SF4  | -10 / -22 | 1400x770x2100 | 1150 | 230V - 50Hz | 175 | 0,98 | R404A         | 430                         | - |
| AIM 14GR3  | -2 / +8   | 1400x870x2100 | 1340 | 230V - 50Hz | 190 | 0,76 | R134A         | 304                         | - |
| AIM 14GR4  | -2 / +8   | 1400x870x2100 | 1340 | 230V - 50Hz | 190 | 0,76 | R134A         | 430                         | - |
| AIM 14GF3  | -10 / -22 | 1400x870x2100 | 1340 | 230V - 50Hz | 190 | 0,98 | R404A         | 304                         | - |
| AIM 14GF4  | -10 / -22 | 1400x870x2100 | 1340 | 230V - 50Hz | 190 | 0,98 | R404A         | 430                         | - |

R290 İstenildiği takdirde fiyatlara %3 ilave edilir. / For R290 Refrigerant gas, price increase is 3%.

## OPSİYONLAR / OPTIONS

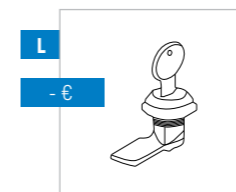

Dolap Kilidi / Cabinet Lock

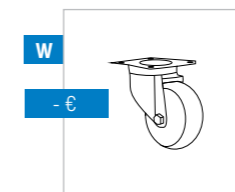

Tekertepli - Wheels

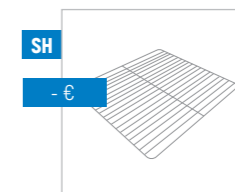
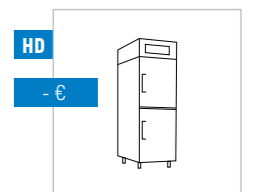
Raf ve Raf Kızağı /  
Shelf and Shelf Holder

Yarım Kapı / Half Door

AIM

AIM 14G

DİKEY TİP BUZDOLAPLARI - 2 CAM KAPILI  
VERTICAL TYPE REFRIGERATORS - W/2 GLASS DOORS

## TEKNİK DETAYLAR / TECHNICAL DETAILS

TR

- Dış ortam sıcaklığı +43°C %65 nem oranı
- Eşit sıcaklık dağılımı için yeni tasarım
- Sıfır ODP enjekte 42 kg/m<sup>3</sup> çevre dostu poliüretan izolasyon
- Kolay okunur ekranlı dijital kontrol
- Ergonomik kapı ve kulpu sayesinde kolay açılma ve temizlik
- Patentli 'Icecool' soğutma sistemi ile mükemmel verim ve enerji sarfiyatı
- Sıcak gaz defrost sistemi
- Atık ısı geri kazanımlı kondansasyon
- Tüm buzdolapların marine versiyonları mevcuttur.
- Marine versiyonları 'Icecool marine' sistemi, marine ayak ve raflar içerir.

EN

- Designed to operate in 43°C ambient %65 humidity
- New design for equal temperature distribution
- Zero ODP Injected 42 kg/m<sup>3</sup> Polyurethane Insulation
- Digital controller with easy read screen
- Ergonomic door and handle designed for ease of opening and cleaning
- Icecool refrigeration system designed to be most technologically advanced and energy efficient yet
- Hot gas defrost system
- Waste heat recovery condensate vaporiser system
- All refrigerators can be produced in marine version
- Marine version includes 'Icecool marine' system, legs and shelves

AIM 14G

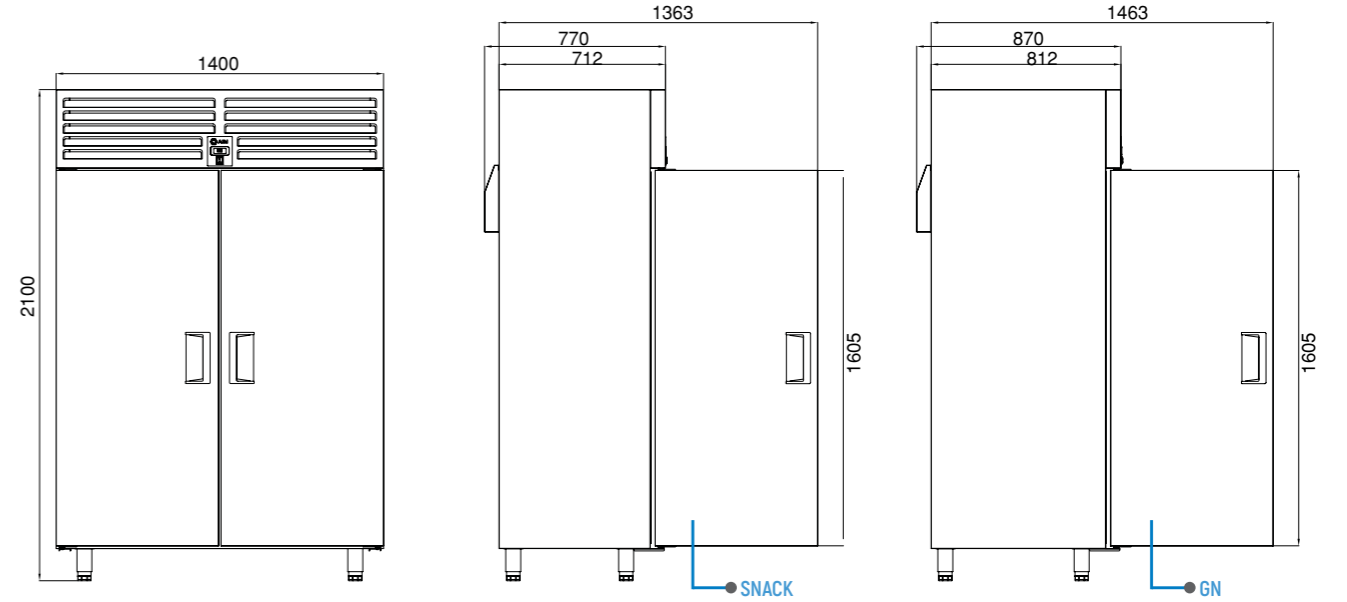

| KOD / CODE  | °C        | (MM)          | lt   | 230V - 50Hz | kg  | (KW) | R134A / R404A | PASLANMAZ TİPİ<br>S.S. TYPE | € |
|-------------|-----------|---------------|------|-------------|-----|------|---------------|-----------------------------|---|
| AIM 14SR3-G | -2 / +8   | 1400x770x2100 | 1150 | 230V - 50Hz | 224 | 0,76 | R134A         | 304                         | - |
| AIM 14SR4-G | -2 / +8   | 1400x770x2100 | 1150 | 230V - 50Hz | 224 | 0,76 | R134A         | 430                         | - |
| AIM 14SF3-G | -10 / -22 | 1400x770x2100 | 1150 | 230V - 50Hz | 224 | 0,98 | R404A         | 304                         | - |
| AIM 14SF4-G | -10 / -22 | 1400x770x2100 | 1150 | 230V - 50Hz | 224 | 0,98 | R404A         | 430                         | - |
| AIM 14GR3-G | -2 / +8   | 1400x870x2100 | 1340 | 230V - 50Hz | 237 | 0,76 | R134A         | 304                         | - |
| AIM 14GR4-G | -2 / +8   | 1400x870x2100 | 1340 | 230V - 50Hz | 237 | 0,76 | R134A         | 430                         | - |
| AIM 14GF3-G | -10 / -22 | 1400x870x2100 | 1340 | 230V - 50Hz | 237 | 0,98 | R404A         | 304                         | - |
| AIM 14GF4-G | -10 / -22 | 1400x870x2100 | 1340 | 230V - 50Hz | 237 | 0,98 | R404A         | 430                         | - |

R290 İstenildiği takdirde fiyatlara %3 ilave edilir. / For R290 Refrigerant gas, price increase is 3%.

## OPSİYONLAR / OPTIONS

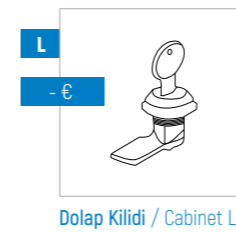

Dolap Kilidi / Cabinet Lock

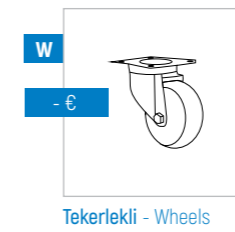

Tekerlekli - Wheels

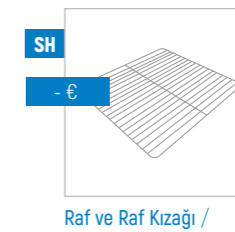
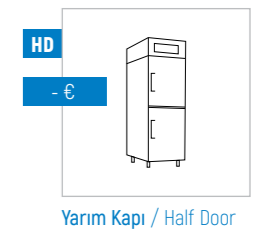
Raf ve Raf Kızağı /  
Shelf and Shelf Holder

Yarım Kapı / Half Door



# AIM 70 COMBI

DİKEY KOMBİ TİP BUZDOLAPLARI - 2 KAPILI  
VERTICAL COMBI TYPE REFRIGERATORS - W/2 DOORS

-2 °C  
+8 °C

-10 °C  
-22 °C



## TEKNİK DETAYLAR / TECHNICAL DETAILS

TR

- Dış ortam sıcaklığı +43°C %65 nem oranı
- Eşit sıcaklık dağılımı için yeni tasarım
- Sıfır ODP enjekte 42 kg/m<sup>3</sup> çevre dostu poliüretan izolasyon
- Kolay okunur ekranlı dijital kontrol
- Ergonomik kapı ve kulpu sayesinde kolay açılma ve temizlik
- Patentli 'Icecool' soğutma sistemi ile mükemmel verim ve enerji sarfiyatı
- Sıcak gaz defrost sistemi
- Atık ısı geri kazanımlı kondansasyon
- Tüm buzdolapların marine versiyonları mevcuttur.
- Marine versiyonları 'Icecool marine' sistemi, marine ayak ve raflar içerir.

EN

- Designed to operate in 43°C ambient %65 humidity
- New design for equal temperature distribution
- Zero ODP Injected 42 kg/m<sup>3</sup> Polyurethane Insulation
- Digital controller with easy read screen
- Ergonomic door and handle designed for ease of opening and cleaning
- Icecool refrigeration system designed to be most technologically advanced and energy efficient yet
- Hot gas defrost system
- Waste heat recovery condensate vaporiser system
- All refrigerators can be produced in marine version
- Marine version includes 'Icecool marine' system, legs and shelves

## AIM 70 COMBI

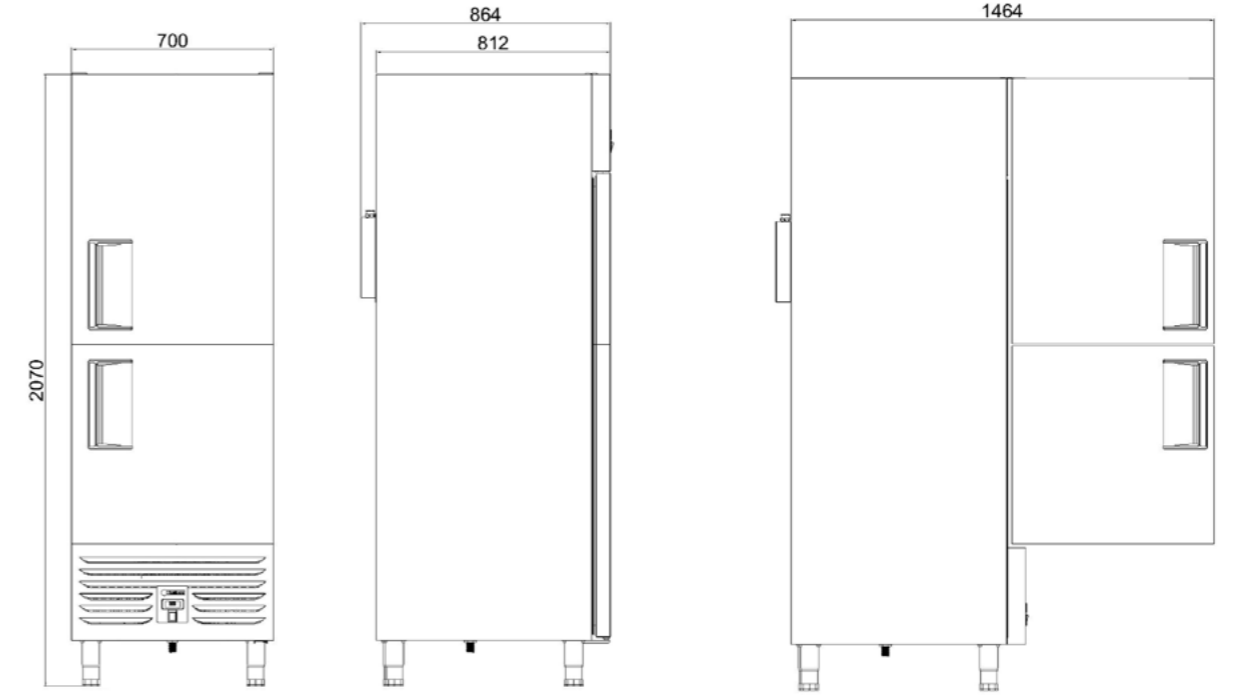

## OPSİYONLAR / OPTIONS

L

- €

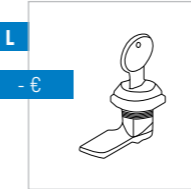

Dolap Kilidi /  
Cabinet Lock

W

- €



Tekerlekli - Wheels

SH

- €

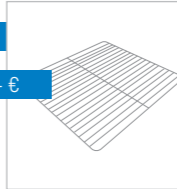

Raf ve Raf Kızağı /  
Shelf and Shelf Holder

| KOD / CODE | 🌡️                   | 📏 (MM)       | 📏 (mm) | 🔌           | 📊 (kg) | ⚡ (kW) | ❄️   | PASLANMAZ TİPİ<br>S.S. TYPE | € |
|------------|----------------------|--------------|--------|-------------|--------|--------|------|-----------------------------|---|
| AIM 70CRF3 | -2 / +8<br>-10 / -22 | 700x864x2070 | 610    | 230V - 50Hz | 125    | 0,65   | R290 | 304                         | - |
| AIM 70CRF4 | -2 / +8<br>-10 / -22 | 700x864x2070 | 610    | 230V - 50Hz | 125    | 0,65   | R290 | 430                         | - |

R290 istenildiği takdirde fiyatlara %3 ilave edilir. / For R290 Refrigerant gas, price increase is 3%.

# SETALTI SOĞUTUCU SERİSİ

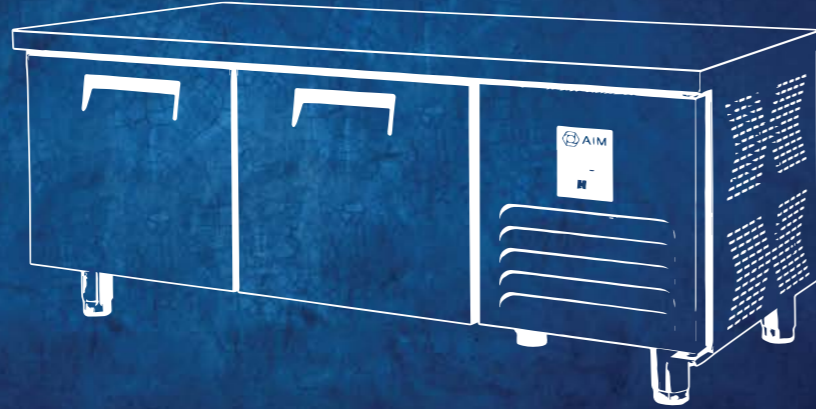

## LOW LEVEL SERIES



### YENİ KONDENSER SİSTEMİ NEW CONDENSER SYSTEM

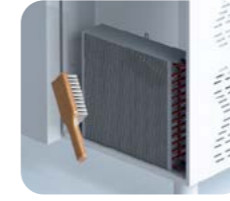

CLASSIC

Temizlik gerektirmeyen kondenser  
Stayclear Condenser



AIMCLEAR



### ENERJİ TASARRUFU SAVING ENERGY

Düşük enerji tüketimi sağlayan çevre dostu  
HFC içermeyen poliüretan izolasyon  
Eco friendly, HFC - free polyurethane insulation  
providing low energy consumption

### KUSURSUZ ISI KONTROLÜ PERFECT HEAT CONTROL



CLASSIC



AIM HEAT

Set altı ek izolasyon çözümümüz ile, ısı kontrolü kusursuz şekilde sağlanır  
With our under counter insulation solution, temperature control is provided perfectly

### SICAK GAZ DEFROST İLE KARLANMAYAN EVAPARATÖR HOT GAS DEFROST SYSTEM PROVIDES NON-FROSTING EVAPORATOR



CLASSIC

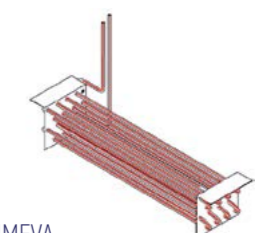

AIMEVA

AIM

## AIM 146L-147L

PIŞIRICI ALTI BUZDOLAPLARI - 2 KAPILI  
LOW LEVEL REFRIGERATORS - W/2 DOORS80mm Üst Tabla İzolasyon Kalınlığı  
80mm Insulation Thickness on top1/1 Çekmece  
1/1 Drawers

## TEKNİK DETAYLAR / TECHNICAL DETAILS

TR

- Dış ortam sıcaklığı +43°C %65 nem oranı
- Eşit sıcaklık dağılımı için yeni tasarım
- Sıfır ODP enjekte 42 kg/m<sup>3</sup> çevre dostu poliüretan izolasyon
- Kolay okunur ekranlı dijital kontrol
- Ergonomik kapı ve kulpu sayesinde kolay açılma ve temizlik
- Patentli 'Icecool' soğutma sistemi ile mükemmel verim ve enerji sarfiyatı
- Sıcak gaz defrost sistemi
- Atık ısı geri kazanımlı kondansasyon
- Tüm buzdolapların marine versiyonları mevcuttur.
- 1/1 Çekmece için; 1/1-200mm Gn kapasitesi.
- 1/2 Çekmece için; 1/1-100mm Gn kapasitesi.

EN

- Designed to operate in 43°C ambient %65 humidity
- New design for equal temperature distribution
- Zero ODP Injected 42 kg/m<sup>3</sup> Polyurethane Insulation
- Digital controller with easy read screen
- Ergonomic door and handle designed for ease of opening and cleaning
- Icecool refrigeration system designed to be most technologically advanced and energy efficient yet
- Hot gas defrost system
- Waste heat recovery condensate vaporiser system
- All refrigerators can be produced in marine version
- For 1/1 drawers; 1/1-200mm Gn capacity
- For 1/2 drawers; 1/1-100mm Gn capacity

AIM 146L-147L

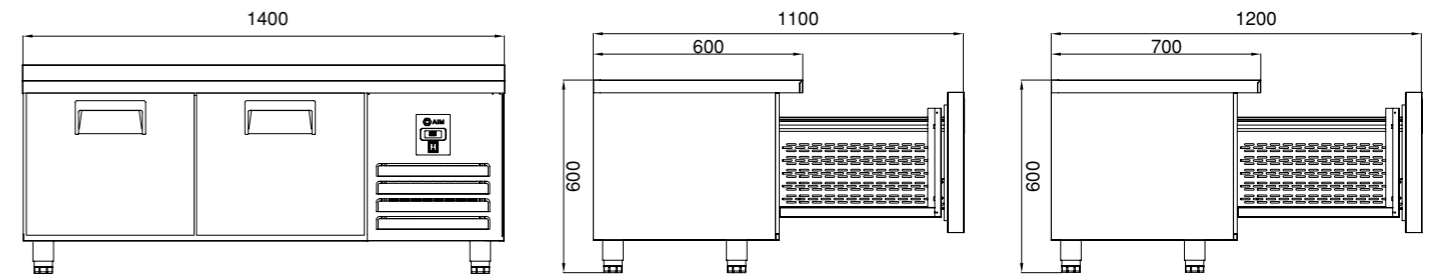

| KOD / CODE | °C        | (MM)         | lt  | 230V - 50Hz | kg | (KW) | R134A / R404A | PASLANMAZ TİPİ<br>S.S. TYPE | € |
|------------|-----------|--------------|-----|-------------|----|------|---------------|-----------------------------|---|
| AIM 146LR3 | -2 / +8   | 1400x600x600 | 190 | 230V - 50Hz | 90 | 0,32 | R134A         | 304                         | - |
| AIM 146LR4 | -2 / +8   | 1400x600x600 | 190 | 230V - 50Hz | 90 | 0,32 | R134A         | 430                         | - |
| AIM 146LF3 | -10 / -22 | 1400x600x600 | 190 | 230V - 50Hz | 90 | 0,68 | R404A         | 304                         | - |
| AIM 146LF4 | -10 / -22 | 1400x600x600 | 190 | 230V - 50Hz | 90 | 0,68 | R404A         | 430                         | - |
| AIM 147LR3 | -2 / +8   | 1400x700x600 | 220 | 230V - 50Hz | 95 | 0,32 | R134A         | 304                         | - |
| AIM 147LR4 | -2 / +8   | 1400x700x600 | 220 | 230V - 50Hz | 95 | 0,32 | R134A         | 430                         | - |
| AIM 147LF3 | -10 / -22 | 1400x700x600 | 220 | 230V - 50Hz | 95 | 0,68 | R404A         | 304                         | - |
| AIM 147LF4 | -10 / -22 | 1400x700x600 | 220 | 230V - 50Hz | 95 | 0,68 | R404A         | 430                         | - |

R290 İstenildiği takdirde fiyatlara %3 ilave edilir. / For R290 Refrigerant gas, price increase is 3%.

## OPSİYONLAR / OPTIONS

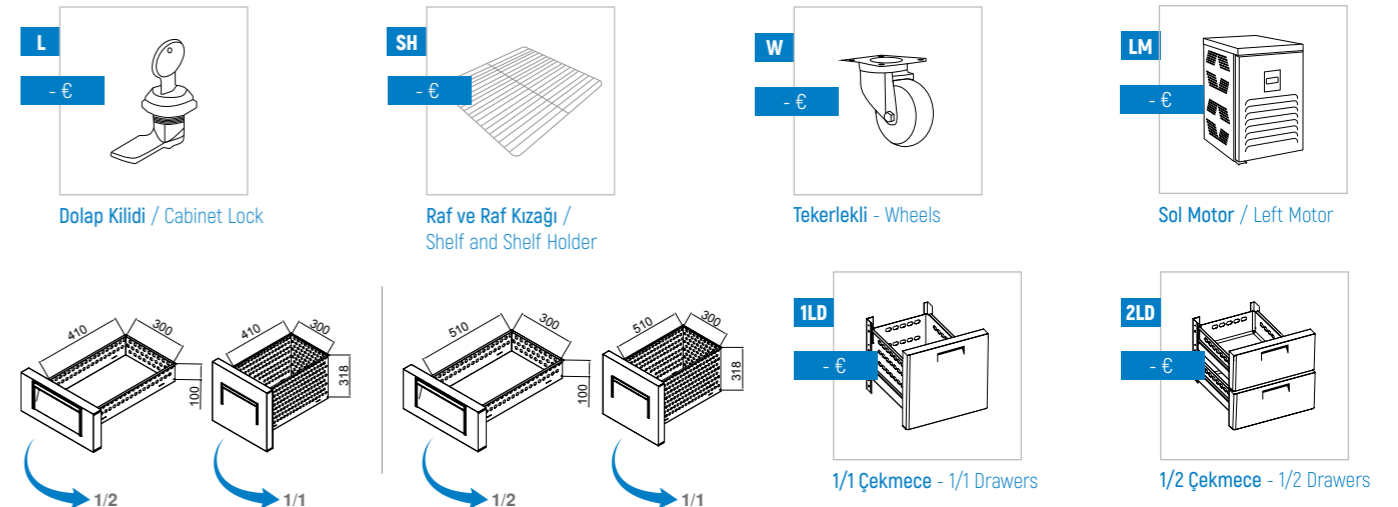

AIM

## AIM 206L-207L

PİŞİRİCİ ALTI BUZDOLAPLARI - 3 KAPILI  
LOW LEVEL REFRIGERATORS - W/3 DOORS80mm Üst Tabla İzolasyon Kalınlığı  
80mm Insulation Thickness on top1/1 Çekmece  
1/1 Drawers

## TEKNİK DETAYLAR / TECHNICAL DETAILS

TR

- Dış ortam sıcaklığı +43°C %65 nem oranı
- Eşit sıcaklık dağılımı için yeni tasarım
- Sıfır ODP enjekte 42 kg/m<sup>3</sup> çevre dostu poliüretan izolasyon
- Kolay okunur ekranlı dijital kontrol
- Ergonomik kapı ve kulpu sayesinde kolay açılma ve temizlik
- Patentli 'Icecool' soğutma sistemi ile mükemmel verim ve enerji sarfiyatı
- Sıcak gaz defrost sistemi
- Atık ısı geri kazanımlı kondansasyon
- Tüm buzdolapların marine versiyonları mevcuttur.
- 1/1 Çekmece için; 1/1-200mm Gn kapasitesi.
- 1/2 Çekmece için; 1/1-100mm Gn kapasitesi.

EN

- Designed to operate in 43°C ambient %65 humidity
- New design for equal temperature distribution
- Zero ODP Injected 42 kg/m<sup>3</sup> Polyurethane Insulation
- Digital controller with easy read screen
- Ergonomic door and handle designed for ease of opening and cleaning
- Icecool refrigeration system designed to be most technologically advanced and energy efficient yet
- Hot gas defrost system
- Waste heat recovery condensate vaporiser system
- All refrigerators can be produced in marine version
- For 1/1 drawers; 1/1-200mm Gn capacity
- For 1/2 drawers; 1/1-100mm Gn capacity

AIM 206L-207L

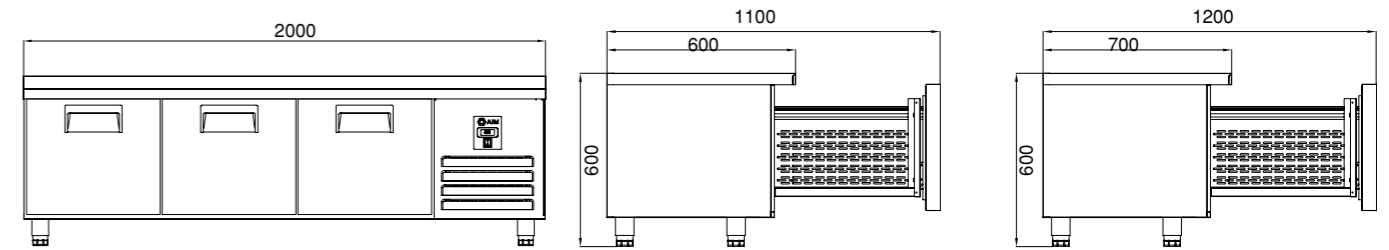

| KOD / CODE | °C        | (MM)         | It  | ⏻           | kg  | (KW) | ❄️    | PASLANMAZ TİPİ<br>S.S. TYPE | € |
|------------|-----------|--------------|-----|-------------|-----|------|-------|-----------------------------|---|
| AIM 206LR3 | -2 / +8   | 2000x600x600 | 280 | 230V - 50Hz | 120 | 0,34 | R134A | 304                         | - |
| AIM 206LR4 | -2 / +8   | 2000x600x600 | 280 | 230V - 50Hz | 120 | 0,34 | R134A | 430                         | - |
| AIM 206LF3 | -10 / -22 | 2000x600x600 | 280 | 230V - 50Hz | 120 | 0,75 | R404A | 304                         | - |
| AIM 206LF4 | -10 / -22 | 2000x600x600 | 280 | 230V - 50Hz | 120 | 0,75 | R404A | 430                         | - |
| AIM 207LR3 | -2 / +8   | 2000x700x600 | 330 | 230V - 50Hz | 128 | 0,34 | R134A | 304                         | - |
| AIM 207LR4 | -2 / +8   | 2000x700x600 | 330 | 230V - 50Hz | 128 | 0,34 | R134A | 430                         | - |
| AIM 207LF3 | -10 / -22 | 2000x700x600 | 330 | 230V - 50Hz | 128 | 0,75 | R404A | 304                         | - |
| AIM 207LF4 | -10 / -22 | 2000x700x600 | 330 | 230V - 50Hz | 128 | 0,75 | R404A | 430                         | - |

R290 İstenildiği takdirde fiyatlara %3 ilave edilir. / For R290 Refrigerant gas, price increase is 3%.

## OPSİYONLAR / OPTIONS

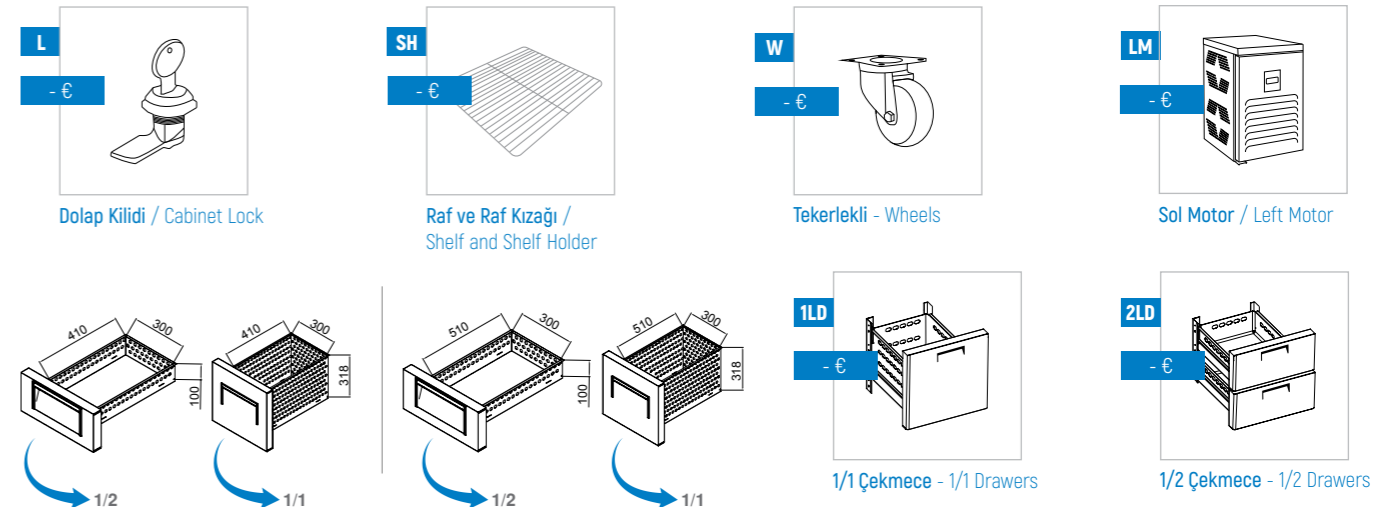

AIM

## AIM 246L-247L

PIŞIRICI ALTI BUZDOLAPLARI - 4 KAPILI  
LOW LEVEL REFRIGERATORS - W/4 DOORS80mm Üst Tabla İzolasyon Kalınlığı  
80mm Insulation Thickness on top

## TEKNİK DETAYLAR / TECHNICAL DETAILS

TR

- Dış ortam sıcaklığı +43°C %65 nem oranı
- Eşit sıcaklık dağılımı için yeni tasarım
- Sıfır ODP enjekte 42 kg/m<sup>3</sup> çevre dostu poliüretan izolasyon
- Kolay okunur ekranlı dijital kontrol
- Ergonomik kapı ve kulpu sayesinde kolay açılma ve temizlik
- Patentli 'Icecool' soğutma sistemi ile mükemmel verim ve enerji sarfiyatı
- Sıcak gaz defrost sistemi
- Atık ısı geri kazanımlı kondansasyon
- Tüm buzdolapların marine versiyonları mevcuttur.
- 1/1 Çekmece için; 1/1-200mm Gn kapasitesi.
- 1/2 Çekmece için; 1/1-100mm Gn kapasitesi.

EN

- Designed to operate in 43°C ambient %65 humidity
- New design for equal temperature distribution
- Zero ODP Injected 42 kg/m<sup>3</sup> Polyurethane Insulation
- Digital controller with easy read screen
- Ergonomic door and handle designed for ease of opening and cleaning
- Icecool refrigeration system designed to be most technologically advanced and energy efficient yet
- Hot gas defrost system
- Waste heat recovery condensate vaporiser system
- All refrigerators can be produced in marine version
- For 1/1 drawers; 1/1-200mm Gn capacity
- For 1/2 drawers; 1/1-100mm Gn capacity

AIM 246L-247L

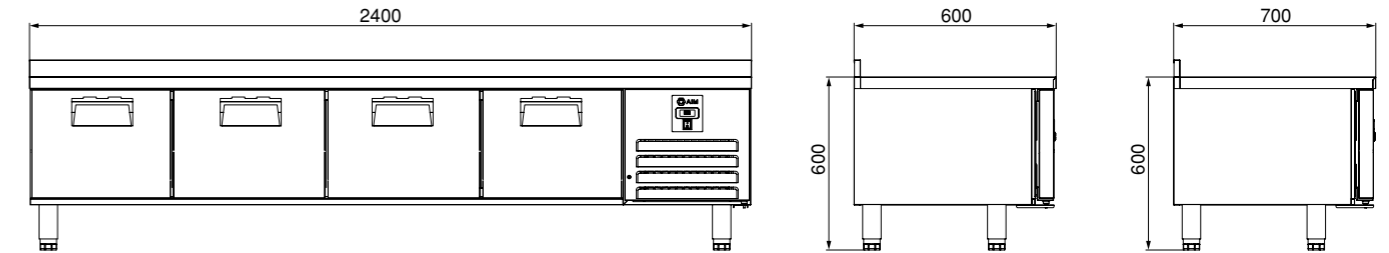

| KOD / CODE | °C        | (MM)         | lt  | ⏻           | kg  | (WATT) | ❄️    | PASLANMAZ TİPİ<br>S.S. TYPE | € |
|------------|-----------|--------------|-----|-------------|-----|--------|-------|-----------------------------|---|
| AIM 246LR3 | -2 / +8   | 2400x600x600 | 370 | 230V - 50Hz | 168 | 0,50   | R134A | 304                         | - |
| AIM 246LR4 | -2 / +8   | 2400x600x600 | 370 | 230V - 50Hz | 168 | 0,50   | R134A | 430                         | - |
| AIM 246LF3 | -10 / -22 | 2400x600x600 | 370 | 230V - 50Hz | 168 | 0,82   | R404A | 304                         | - |
| AIM 246LF4 | -10 / -22 | 2400x600x600 | 370 | 230V - 50Hz | 168 | 0,82   | R404A | 430                         | - |
| AIM 247LR3 | -2 / +8   | 2400x700x600 | 450 | 230V - 50Hz | 177 | 0,50   | R134A | 304                         | - |
| AIM 247LR4 | -2 / +8   | 2400x700x600 | 450 | 230V - 50Hz | 177 | 0,50   | R134A | 430                         | - |
| AIM 247LF3 | -10 / -22 | 2400x700x600 | 450 | 230V - 50Hz | 177 | 0,82   | R404A | 304                         | - |
| AIM 247LF4 | -10 / -22 | 2400x700x600 | 450 | 230V - 50Hz | 177 | 0,82   | R404A | 430                         | - |

R290 İstenildiği takdirde fiyatlara %3 ilave edilir. / For R290 Refrigerant gas, price increase is 3%.

## OPSİYONLAR / OPTIONS

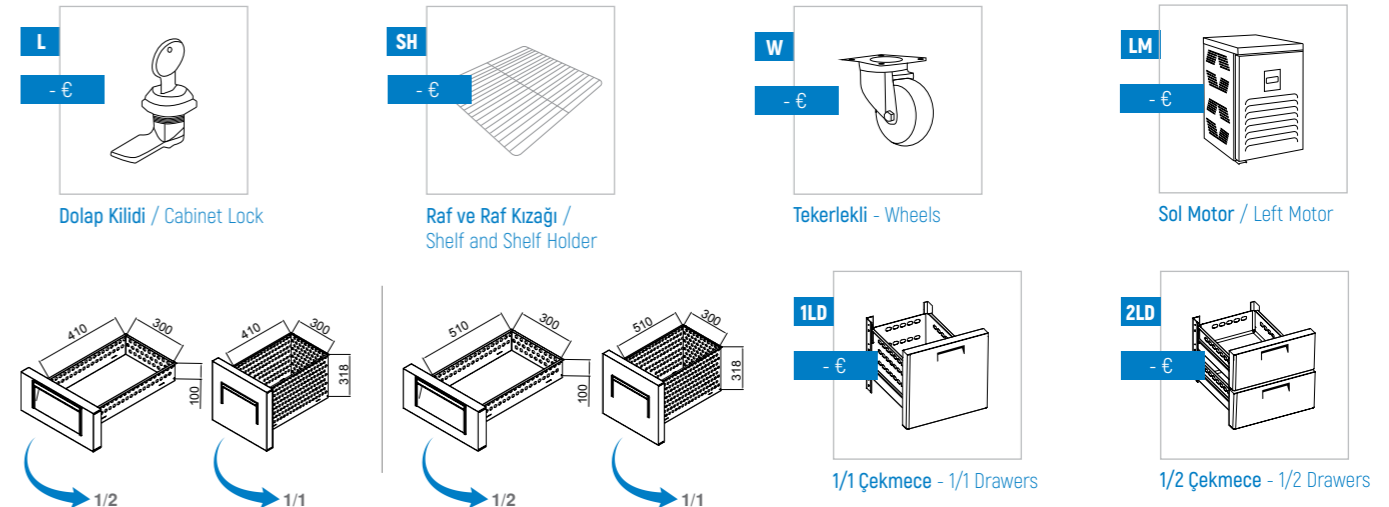

AIM

## AIM 126L-127L

PIŞIRICI ALTI BUZDOLAPLARI - 2 KAPILI - KISA  
LOW LEVEL REFRIGERATORS - W/2 DOORS - SHORT

80mm Üst Tabla İzolasyon Kalınlığı  
80mm Insulation Thickness on top



1/1 Çekmece  
1/1 Drawers



| KOD / CODE | °C      | (MM)         | It  | 230V - 50Hz | kg | (KW) | R134A | PASLANMAZ TİPİ<br>S.S. TYPE | € |
|------------|---------|--------------|-----|-------------|----|------|-------|-----------------------------|---|
| AIM 126LR3 | -2 / +8 | 1200x600x600 | 190 | 230V - 50Hz | 90 | 0,32 | R134A | 304                         | - |
| AIM 126LR4 | -2 / +8 | 1200x600x600 | 190 | 230V - 50Hz | 90 | 0,32 | R134A | 430                         | - |
| AIM 127LR3 | -2 / +8 | 1200x700x600 | 220 | 230V - 50Hz | 95 | 0,32 | R134A | 304                         | - |
| AIM 127LR4 | -2 / +8 | 1200x700x600 | 220 | 230V - 50Hz | 95 | 0,32 | R134A | 430                         | - |

R290 İstenildiği takdirde fiyatlara %3 ilave edilir. / For R290 Refrigerant gas, price increase is 3%.

## TEKNİK DETAYLAR / TECHNICAL DETAILS

TR

- Dış ortam sıcaklığı +43°C %65 nem oranı
- Eşit sıcaklık dağılımı için yeni tasarım
- Sıfır ODP enjekte 42 kg/m<sup>3</sup> çevre dostu poliüretan izolasyon
- Kolay okunur ekranlı dijital kontrol
- Ergonomik kapı ve kulpu sayesinde kolay açılma ve temizlik
- Patentli 'Icecool' soğutma sistemi ile mükemmel verim ve enerji sarfiyatı
- Sıcak gaz defrost sistemi
- Atık ısı geri kazanımlı kondansasyon
- Tüm buzdolapların marine versiyonları mevcuttur.
- 1/1 Çekmece için; 1/1-200mm Gn kapasitesi.
- 1/2 Çekmece için; 1/1-100mm Gn kapasitesi.

EN

- Designed to operate in 43°C ambient %65 humidity
- New design for equal temperature distribution
- Zero ODP Injected 42 kg/m<sup>3</sup> Polyurethane Insulation
- Digital controller with easy read screen
- Ergonomic door and handle designed for ease of opening and cleaning
- Icecool refrigeration system designed to be most technologically advanced and energy efficient yet
- Hot gas defrost system
- Waste heat recovery condensate vaporiser system
- All refrigerators can be produced in marine version
- For 1/1 drawers; 1/1-200mm Gn capacity
- For 1/2 drawers; 1/1-100mm Gn capacity

AIM 126L-127L

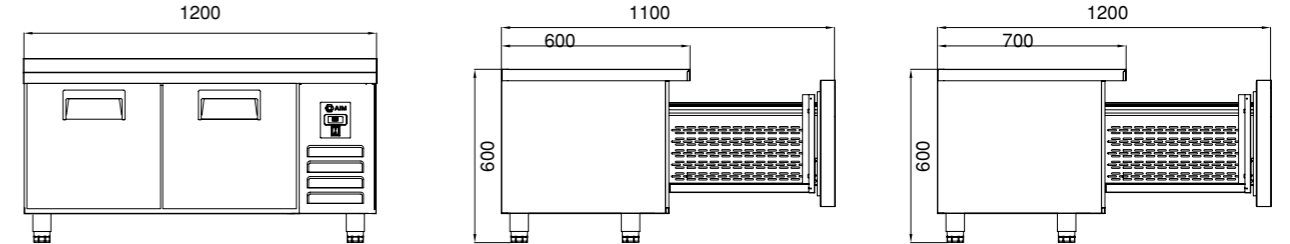

## OPSİYONLAR / OPTIONS

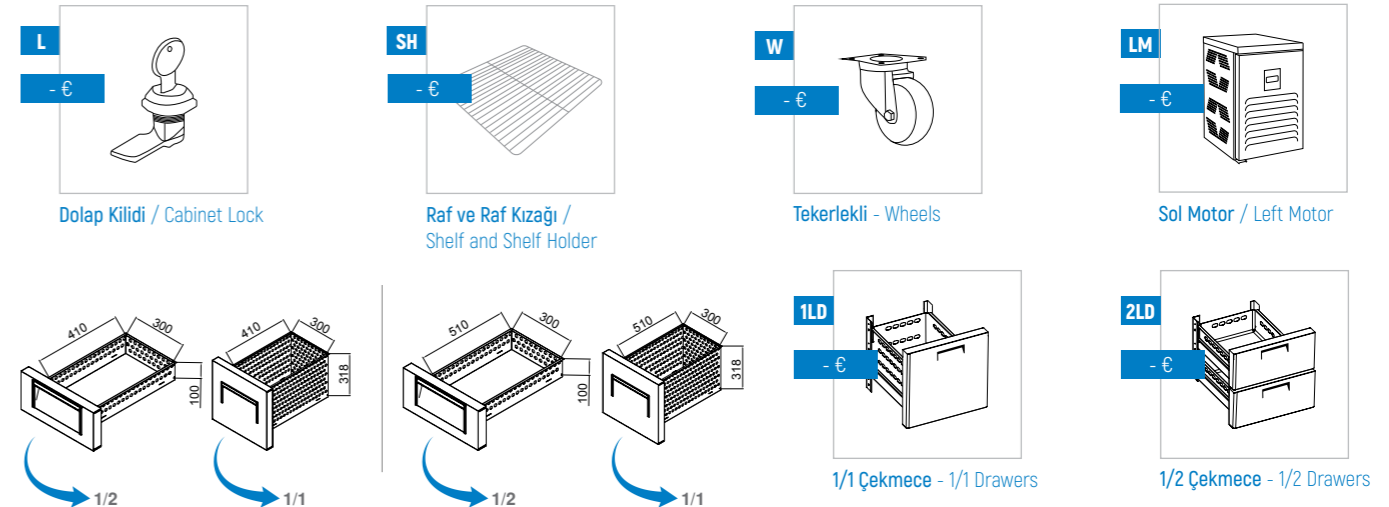

AIM

## AIM 166L-167L

PIŞIRICI ALTI BUZDOLAPLARI - 3 KAPILI - KISA  
LOW LEVEL REFRIGERATORS - W/3 KAPILI - SHORT

80mm Üst Tabla İzolasyon Kalınlığı  
80mm Insulation Thickness on top



1/1 Çekmece  
1/1 Drawers



| KOD / CODE | °C      | (MM)         | It  | ⏻           | kg  | (KW) | ⚡     | PASLANMAZ TİPİ<br>S.S. TYPE | € |
|------------|---------|--------------|-----|-------------|-----|------|-------|-----------------------------|---|
| AIM 166LR3 | -2 / +8 | 1600x600x600 | 280 | 230V - 50Hz | 118 | 0,40 | R134A | 304                         | - |
| AIM 166LR4 | -2 / +8 | 1600x600x600 | 280 | 230V - 50Hz | 118 | 0,40 | R134A | 430                         | - |
| AIM 167LR3 | -2 / +8 | 1600x700x600 | 330 | 230V - 50Hz | 125 | 0,40 | R134A | 304                         | - |
| AIM 167LR4 | -2 / +8 | 1600x700x600 | 330 | 230V - 50Hz | 125 | 0,40 | R134A | 430                         | - |

R290 İstenildiği takdirde fiyatlara %3 ilave edilir. / For R290 Refrigerant gas, price increase is 3%.

## TEKNİK DETAYLAR / TECHNICAL DETAILS

TR

- Dış ortam sıcaklığı +43°C %65 nem oranı
- Eşit sıcaklık dağılımı için yeni tasarım
- Sıfır ODP enjekte 42 kg/m<sup>3</sup> çevre dostu poliüretan izolasyon
- Kolay okunur ekranlı dijital kontrol
- Ergonomik kapı ve kulpu sayesinde kolay açılma ve temizlik
- Patentli 'Icecool' soğutma sistemi ile mükemmel verim ve enerji sarfiyatı
- Sıcak gaz defrost sistemi
- Atık ısı geri kazanımlı kondansasyon
- Tüm buzdolapların marine versiyonları mevcuttur.
- 1/1 Çekmece için; 1/1-200mm Gn kapasitesi.
- 1/2 Çekmece için; 1/1-100mm Gn kapasitesi.

EN

- Designed to operate in 43°C ambient %65 humidity
- New design for equal temperature distribution
- Zero ODP Injected 42 kg/m<sup>3</sup> Polyurethane Insulation
- Digital controller with easy read screen
- Ergonomic door and handle designed for ease of opening and cleaning
- Icecool refrigeration system designed to be most technologically advanced and energy efficient yet
- Hot gas defrost system
- Waste heat recovery condensate vaporiser system
- All refrigerators can be produced in marine version
- For 1/1 drawers; 1/1-200mm Gn capacity
- For 1/2 drawers; 1/1-100mm Gn capacity

AIM 166L-167L

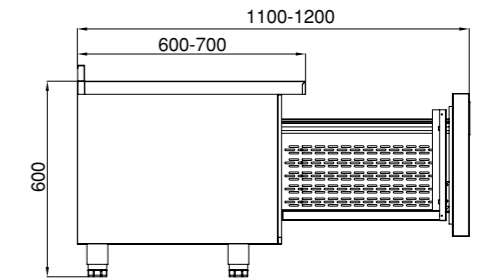
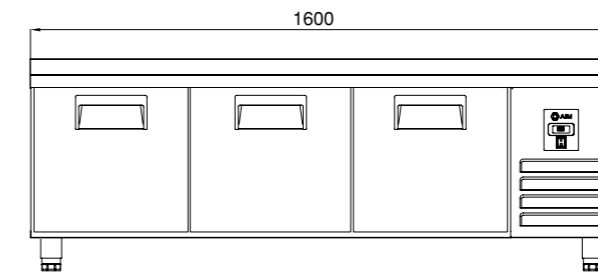

## OPSİYONLAR / OPTIONS

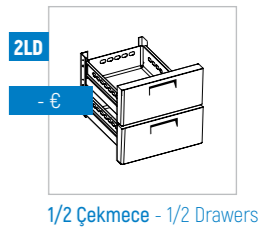
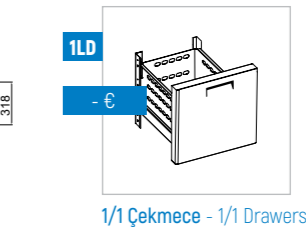
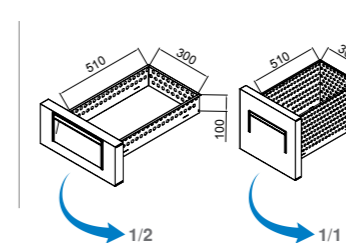
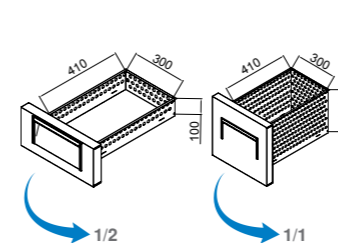
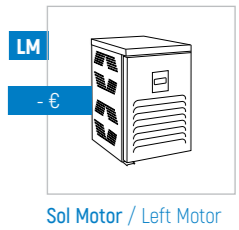
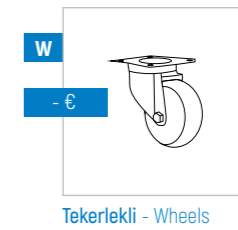
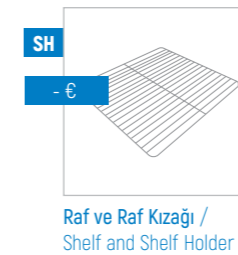
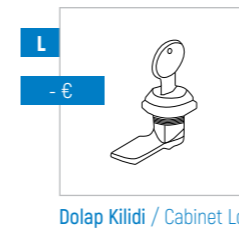

# HAZIRLIK BUZDOLAPLARI

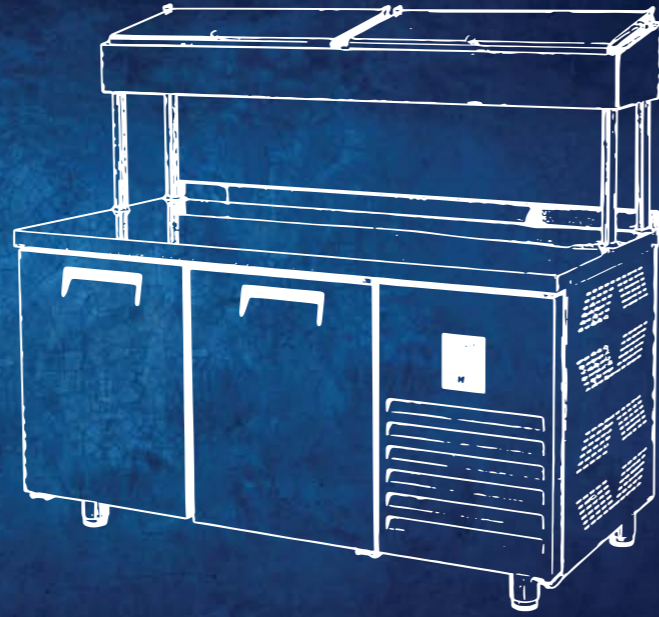

## MAKE-UP SERIES

### YENİ KONDENSER SİSTEMİ NEW CONDENSER SYSTEM

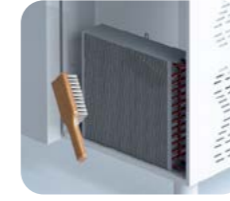

CLASSIC



AIMCLEAR

Temizlik gerektirmeyen kondenser  
Stayclear Condenser

### ENERJİ TASARRUFU SAVING ENERGY



Düşük enerji tüketimi sağlayan çevre dostu HFC içermeyen poliüretan izolasyon  
Eco friendly, HFC - free polyurethane insulation providing low energy consumption

### SICAK GAZ DEFOST İLE KARLANMAYAN EVAPARATÖR EVAPARATOR DOES NOT SNOW THROUGH HOT GAS DEFROST

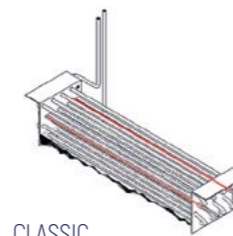

CLASSIC

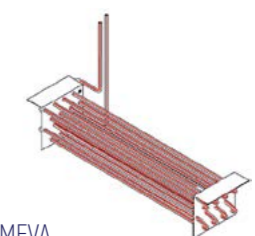

AIMEVA

AIM

## AIM 156M-157M

MAKE UP BUZDOLAPLARI - 2 KAPILI - YÜKSEK  
MAKE UP REFRIGERATORS - W/2 DOORS - HIGH1/2 Çekmece  
1/2 Drawers

| KOD / CODE | °C      | (MM)              | lt  | ⏻           | kg  | (KW) | ❄️    | PASLANMAZ TİPİ<br>S.S. TYPE | € |
|------------|---------|-------------------|-----|-------------|-----|------|-------|-----------------------------|---|
| AIM 156M3  | -2 / +8 | 1500x600x850/1430 | 275 | 230V - 50Hz | 116 | 0,32 | R134A | 304                         | - |
| AIM 156M4  | -2 / +8 | 1500x600x850/1430 | 275 | 230V - 50Hz | 116 | 0,32 | R134A | 430                         | - |
| AIM 157M3  | -2 / +8 | 1500x700x850/1430 | 330 | 230V - 50Hz | 123 | 0,32 | R134A | 304                         | - |
| AIM 157M4  | -2 / +8 | 1500x700x850/1430 | 330 | 230V - 50Hz | 123 | 0,32 | R134A | 430                         | - |

R290 İstenildiği takdirde fiyatlara %3 ilave edilir. / For R290 Refrigerant gas, price increase is 3%.

www.aimgastro.com

## TEKNİK DETAYLAR / TECHNICAL DETAILS

TR

- Dış ortam sıcaklığı +43°C %65 nem oranı
- Eşit sıcaklık dağılımı için yeni tasarım
- Sıfır ODP enjekte 42 kg/m<sup>3</sup> çevre dostu poliüretan izolasyon
- Kolay okunur ekranlı dijital kontrol
- Ergonomik kapı ve kulpu sayesinde kolay açılma ve temizlik
- Patentli 'Icecool' soğutma sistemi ile mükemmel verim ve enerji sarfiyatı
- Sıcak gaz defrost sistemi
- Atık ısı geri kazanımlı kondanzasyon
- Tüm buzdolapların marine versiyonları mevcuttur.
- 8 Adet 1/4-100 Gn kapasitesi.

EN

- Designed to operate in 43°C ambient %65 humidity
- New design for equal temperature distribution
- Zero ODP Injected 42 kg/m<sup>3</sup> Polyurethane Insulation
- Digital controller with easy read screen
- Ergonomic door and handle designed for ease of opening and cleaning
- Icecool refrigeration system designed to be most technologically advanced and energy efficient yet
- Hot gas defrost system
- Waste heat recovery condensate vaporiser system
- All refrigerators can be produced in marine version
- 8 No's 1/4-100mm Gn capacity

## AIM 156M-157M

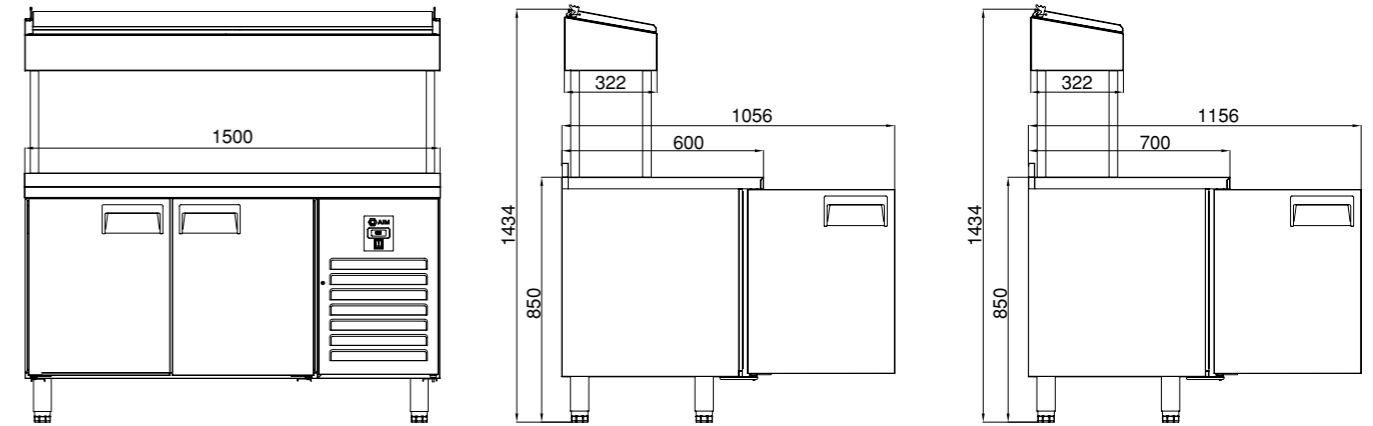

## OPSİYONLAR / OPTIONS

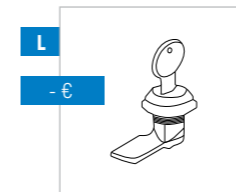

Dolap Kilidi / Cabinet Lock

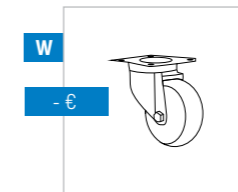

Tekerlekli - Wheels

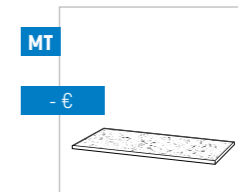

Mermer Tabla / Marble Top

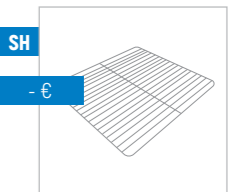
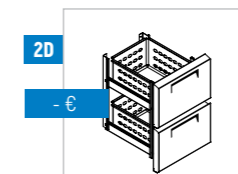
Raf ve Raf Kızağı /  
Shelf and Shelf HolderGastronom kuvvetler fiyata dahil değildir.  
Gn containers are not included in the price.

1/2 Çekmece - 1/2 Drawers

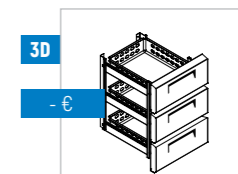

1/3 Çekmece - 1/3 Drawers

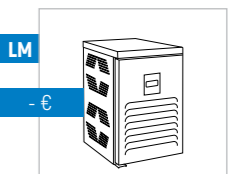

Sol Motor / Left Motor

www.aimgastro.com

## AIM 206M-207M

MAKE UP BUZDOLAPLARI - 3 KAPILI - YÜKSEK  
MAKE UP REFRIGERATORS - W/3 DOORS - HIGH



1/2 Çekmece  
1/2 Drawers



| KOD / CODE | °C      | (MM)              | lit | ⏻           | kg  | (KW) | ❄️    | PASLANMAZ TİPİ<br>S.S. TYPE | € |
|------------|---------|-------------------|-----|-------------|-----|------|-------|-----------------------------|---|
| AIM 206M3  | -2 / +8 | 2000x600x850/1430 | 440 | 230V - 50Hz | 195 | 0,40 | R134A | 304                         | - |
| AIM 206M4  | -2 / +8 | 2000x600x850/1430 | 440 | 230V - 50Hz | 195 | 0,40 | R134A | 430                         | - |
| AIM 207M3  | -2 / +8 | 2000x700x850/1430 | 515 | 230V - 50Hz | 205 | 0,40 | R134A | 304                         | - |
| AIM 207M4  | -2 / +8 | 2000x700x850/1430 | 515 | 230V - 50Hz | 205 | 0,40 | R134A | 430                         | - |

R290 İstenildiği takdirde fiyatlara %3 ilave edilir. / For R290 Refrigerant gas, price increase is 3%.

## TEKNİK DETAYLAR / TECHNICAL DETAILS

TR

- Dış ortam sıcaklığı +43°C %65 nem oranı
- Eşit sıcaklık dağılımı için yeni tasarım
- Sıfır ODP enjekte 42 kg/m<sup>3</sup> çevre dostu poliüretan izolasyon
- Kolay okunur ekranlı dijital kontrol
- Ergonomik kapı ve kulpu sayesinde kolay açılma ve temizlik
- Patentli 'Icecool' soğutma sistemi ile mükemmel verim ve enerji sarfiyatı
- Sıcak gaz defrost sistemi
- Atık ısı geri kazanımlı kondanzasyon
- Tüm buzdolapların marine versiyonları mevcuttur.
- 12 Adet 1/4-100 Gn kapasitesi.

EN

- Designed to operate in 43°C ambient %65 humidity
- New design for equal temperature distribution
- Zero ODP Injected 42 kg/m<sup>3</sup> Polyurethane Insulation
- Digital controller with easy read screen
- Ergonomic door and handle designed for ease of opening and cleaning
- Icecool refrigeration system designed to be most technologically advanced and energy efficient yet
- Hot gas defrost system
- Waste heat recovery condensate vaporiser system
- All refrigerators can be produced in marine version
- 12 No's 1/4-100mm Gn capacity

AIM 206M-207M

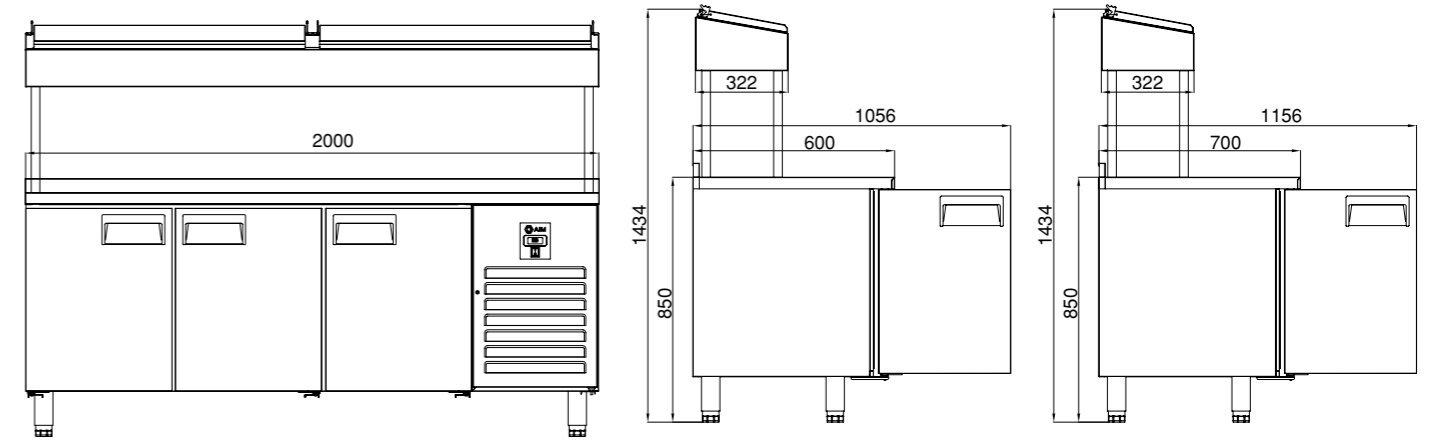

## OPSİYONLAR / OPTIONS

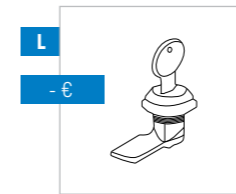

Dolap Kilidi / Cabinet Lock

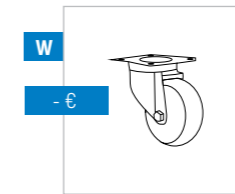

Tekerlekli - Wheels

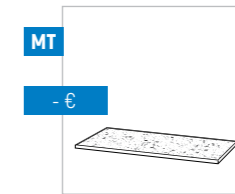

Mermer Tabla / Marble Top

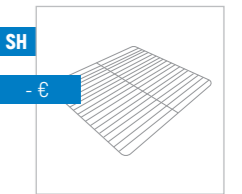
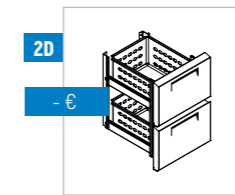
Raflar ve Raflar Kızağı /  
Shelf and Shelf HolderGastronom kuvvetler fiyata dahil değildir.  
Gn containers are not included in the price.

1/2 Çekmece - 1/2 Drawers

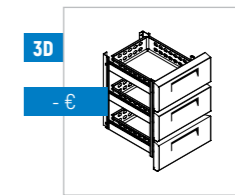

1/3 Çekmece - 1/3 Drawers

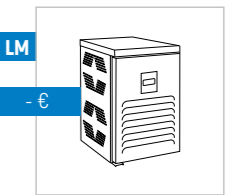

Sol Motor / Left Motor

AIM

## AIM 256M-257M

MAKE UP BUZDOLAPLARI - 4 KAPILI - YÜKSEK  
MAKE UP REFRIGERATORS - W/4 DOORS - HIGH1/2 Çekmece  
1/2 Drawers

| KOD / CODE | °C      | (MM)              | It  | Power       | kg  | (KW) | R134A | PASLANMAZ TİPİ<br>S.S. TYPE | € |
|------------|---------|-------------------|-----|-------------|-----|------|-------|-----------------------------|---|
| AIM 256M3  | -2 / +8 | 2500x600x850/1430 | 560 | 230V - 50Hz | 198 | 0,50 | R134A | 304                         | - |
| AIM 256M4  | -2 / +8 | 2500x600x850/1430 | 560 | 230V - 50Hz | 198 | 0,50 | R134A | 430                         | - |
| AIM 257M3  | -2 / +8 | 2500x700x850/1430 | 650 | 230V - 50Hz | 209 | 0,50 | R134A | 304                         | - |
| AIM 257M4  | -2 / +8 | 2500x700x850/1430 | 650 | 230V - 50Hz | 209 | 0,50 | R134A | 430                         | - |

R290 İstenildiği takdirde fiyatlara %3 ilave edilir. / For R290 Refrigerant gas, price increase is 3%.

## TEKNİK DETAYLAR / TECHNICAL DETAILS

TR

- Dış ortam sıcaklığı +43°C %65 nem oranı
- Eşit sıcaklık dağılımı için yeni tasarım
- Sıfır ODP enjekte 42 kg/m<sup>3</sup> çevre dostu poliüretan izolasyon
- Kolay okunur ekranlı dijital kontrol
- Ergonomik kapı ve kulpu sayesinde kolay açılma ve temizlik
- Patentli 'Icecool' soğutma sistemi ile mükemmel verim ve enerji sarfiyatı
- Sıcak gaz defrost sistemi
- Atık ısı geri kazanımlı kondanzasyon
- Tüm buzdolapların marine versiyonları mevcuttur.
- 15 Adet 1/4-100 Gn kapasitesi.



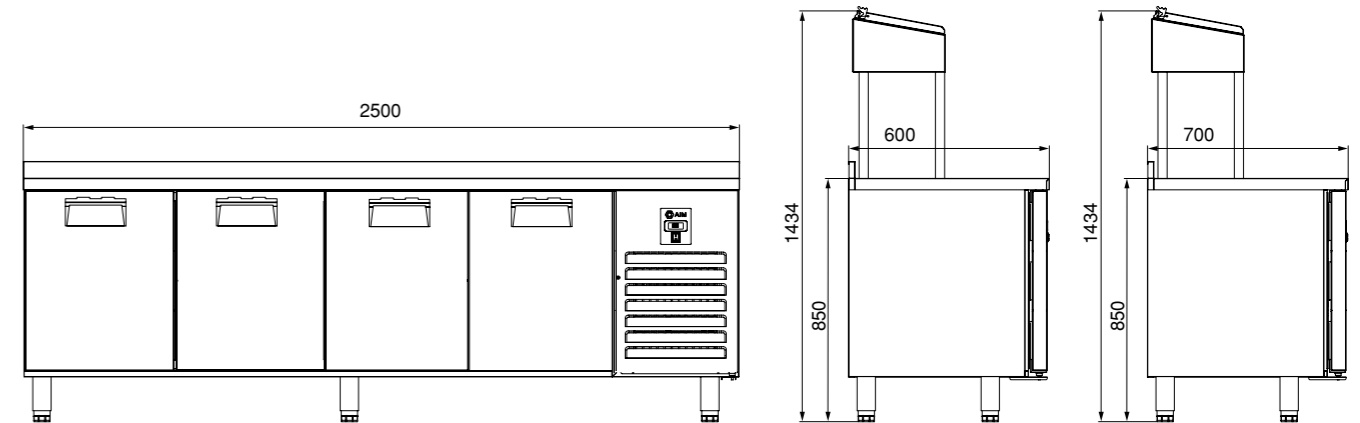

EN

- Designed to operate in 43°C ambient %65 humidity
- New design for equal temperature distribution
- Zero ODP Injected 42 kg/m<sup>3</sup> Polyurethane Insulation
- Digital controller with easy read screen
- Ergonomic door and handle designed for ease of opening and cleaning
- Icecool refrigeration system designed to be most technologically advanced and energy efficient yet
- Hot gas defrost system
- Waste heat recovery condensate vaporiser system
- All refrigerators can be produced in marine version
- 15 No's 1/4-100mm Gn capacity

## AIM 256M-257M

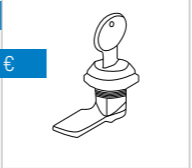

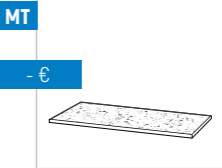
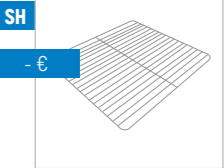
## OPSİYONLAR / OPTIONS

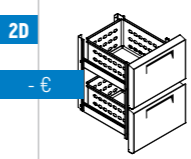
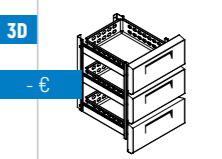
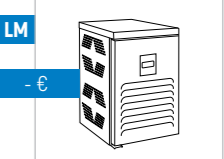
|   |  |  |   |
|---|--|--|---|
| <p><b>L</b></p> <p>- €</p>  <p>Dolap Kilidi / Cabinet Lock</p>                                     | <p><b>W</b></p> <p>- €</p>  <p>Tekerlekli - Wheels</p>        | <p><b>MT</b></p> <p>- €</p>  <p>Mermer Tabla / Marble Top</p> | <p><b>SH</b></p> <p>- €</p>  <p>Raf ve Raf Kızağı / Shelf and Shelf Holder</p> |
|  <p>Gastronom kuvetler fiyata dahil değildir.<br/>Gn containers are not included in the price.</p> | <p><b>2D</b></p> <p>- €</p>  <p>1/2 Çekmece - 1/2 Drawers</p> | <p><b>3D</b></p> <p>- €</p>  <p>1/3 Çekmece - 1/3 Drawers</p> | <p><b>LM</b></p> <p>- €</p>  <p>Sol Motor / Left Motor</p>                     |

AIM

## AIM 157MS

MAKE UP BUZDOLAPLARI - 2 KAPILI - KISA  
MAKE UP REFRIGERATORS - W/2 DOORS - SHORT

## TEKNİK DETAYLAR / TECHNICAL DETAILS

TR

- Dış ortam sıcaklığı +43°C %65 nem oranı
- Eşit sıcaklık dağılımı için yeni tasarım
- Sıfır ODP enjekte 42 kg/m<sup>3</sup> çevre dostu poliüretan izolasyon
- Kolay okunur ekranlı dijital kontrol
- Ergonomik kapı ve kulpu sayesinde kolay açılma ve temizlik
- Patentli 'Icecool' soğutma sistemi ile mükemmel verim ve enerji sarfiyatı
- Sıcak gaz defrost sistemi
- Atık ısı geri kazanımlı kondanzasyon
- Tüm buzdolapların marine versiyonları mevcuttur.
- **8 Adet 1/4-100 Gn kapasitesi.**

EN

- Designed to operate in 43°C ambient %65 humidity
- New design for equal temperature distribution
- Zero ODP Injected 42 kg/m<sup>3</sup> Polyurethane Insulation
- Digital controller with easy read screen
- Ergonomic door and handle designed for ease of opening and cleaning
- Icecool refrigeration system designed to be most technologically advanced and energy efficient yet
- Hot gas defrost system
- Waste heat recovery condensate vaporiser system
- All refrigerators can be produced in marine version
- **8 No's 1/4-100mm Gn capacity**

## AIM 157MS

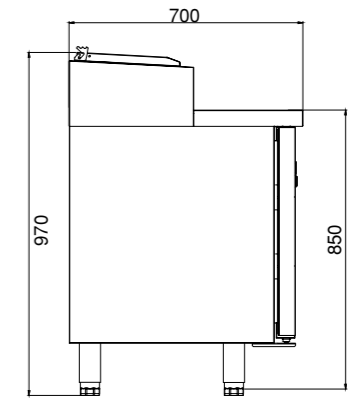
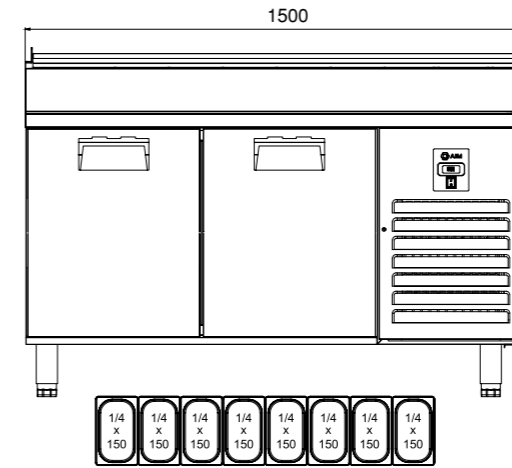

## OPSİYONLAR / OPTIONS

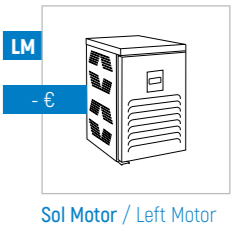
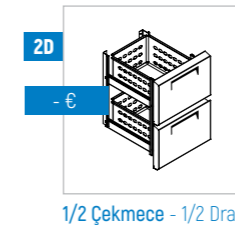
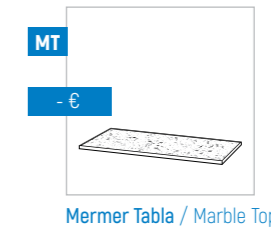
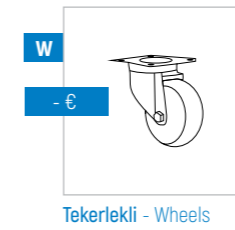
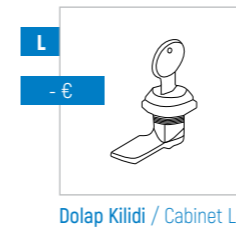

| KOD / CODE | °C      | (MM)             | lt  | 230V - 50Hz | kg  | (KW) | R134A | PASLANMAZ TİPİ<br>S.S. TYPE | € |
|------------|---------|------------------|-----|-------------|-----|------|-------|-----------------------------|---|
| AIM 157MS3 | -2 / +8 | 1500x700x850/970 | 330 | 230V - 50Hz | 123 | 0,32 | R134A | 304                         | - |
| AIM 157MS4 | -2 / +8 | 1500x700x850/970 | 330 | 230V - 50Hz | 123 | 0,32 | R134A | 430                         | - |

R290 İstenildiği takdirde fiyatlara %3 ilave edilir. / For R290 Refrigerant gas, price increase is 3%.

Gastronom kuvvetler fiyata dahil değildir.  
Gn containers are not included in the price.

1/2 Çekmece - 1/2 Drawers

1/3 Çekmece - 1/3 Drawers

Sol Motor / Left Motor

AIM

## AIM 207MS

MAKE UP BUZDOLAPLARI - 3 KAPILI - KISA  
MAKE UP REFRIGERATORS - W/3 DOORS - SHORT

## TEKNİK DETAYLAR / TECHNICAL DETAILS

TR

- Dış ortam sıcaklığı +43°C %65 nem oranı
- Eşit sıcaklık dağılımı için yeni tasarım
- Sıfır ODP enjekte 42 kg/m<sup>3</sup> çevre dostu poliüretan izolasyon
- Kolay okunur ekranlı dijital kontrol
- Ergonomik kapı ve kulpu sayesinde kolay açılma ve temizlik
- Patentli 'Icecool' soğutma sistemi ile mükemmel verim ve enerji sarfiyatı
- Sıcak gaz defrost sistemi
- Atık ısı geri kazanımlı kondanzasyon
- Tüm buzdolapların marine versiyonları mevcuttur.
- 11 Adet 1/4-100 Gn kapasitesi.

EN

- Designed to operate in 43°C ambient %65 humidity
- New design for equal temperature distribution
- Zero ODP Injected 42 kg/m<sup>3</sup> Polyurethane Insulation
- Digital controller with easy read screen
- Ergonomic door and handle designed for ease of opening and cleaning
- Icecool refrigeration system designed to be most technologically advanced and energy efficient yet
- Hot gas defrost system
- Waste heat recovery condensate vaporiser system
- All refrigerators can be produced in marine version
- 11 No's 1/4-100mm Gn capacity

AIM 207MS

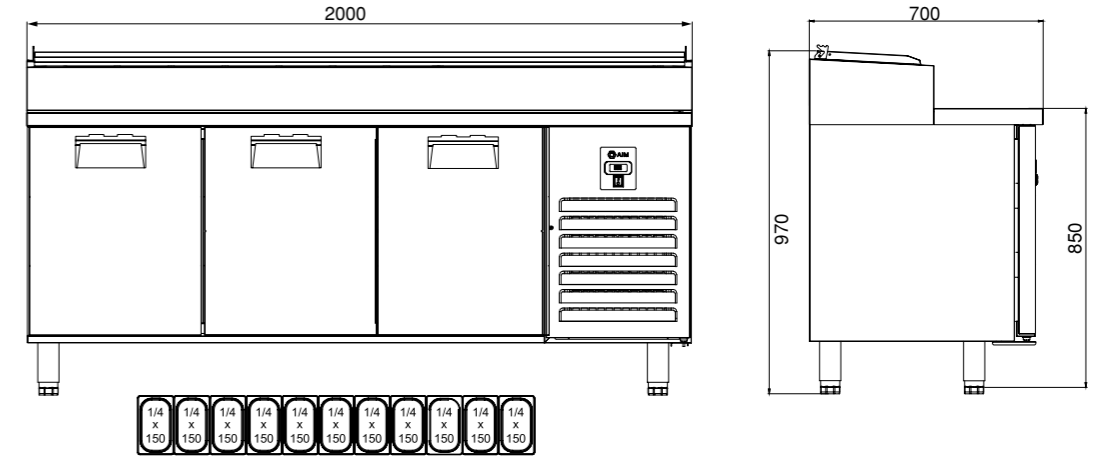

## OPSİYONLAR / OPTIONS

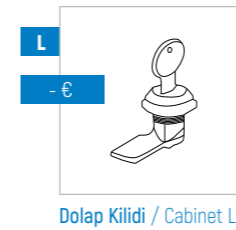

Dolap Kilidi / Cabinet Lock

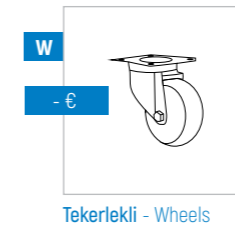

Tekerlekli - Wheels

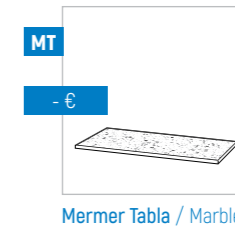

Mermer Tabla / Marble Top

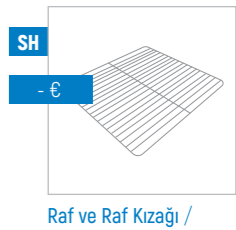
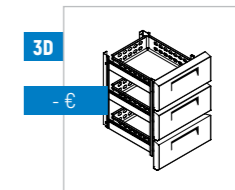
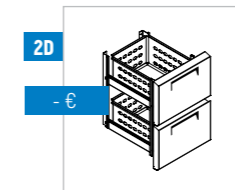
Raf ve Raf Kızağı /  
Shelf and Shelf HolderGastronom kuvvetler fiyata dahil değildir.  
Gn containers are not included in the price.

1/3 Çekmece - 1/3 Drawers

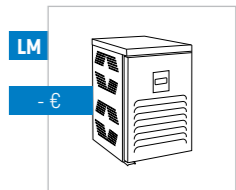

Sol Motor / Left Motor

| KOD / CODE | °C      | (MM)         | it  | 230V - 50Hz | kg  | (KW) | R134A | PASLANMAZ TİPİ<br>S.S. TYPE | € |
|------------|---------|--------------|-----|-------------|-----|------|-------|-----------------------------|---|
| AIM 207MS3 | -2 / +8 | 2000x700x970 | 515 | 230V - 50Hz | 205 | 0,36 | R134A | 304                         | - |
| AIM 207MS4 | -2 / +8 | 2000x700x970 | 515 | 230V - 50Hz | 205 | 0,36 | R134A | 430                         | - |

R290 İstenildiği takdirde fiyatlara %3 ilave edilir. / For R290 Refrigerant gas, price increase is 3%.

AIM

## AIM 257MS

MAKE UP BUZDOLAPLARI - 4 KAPILI - KISA  
MAKE UP REFRIGERATORS - W/4 DOORS - SHORT

| KOD / CODE | °C      | (MM)         | lit | ⏻           | kg  | [KW] | ❄️    | PASLANMAZ TİPİ<br>S.S. TYPE | € |
|------------|---------|--------------|-----|-------------|-----|------|-------|-----------------------------|---|
| AIM 257MS3 | -2 / +8 | 2500x700x970 | 650 | 230V - 50Hz | 209 | 0,50 | R134A | 304                         | - |
| AIM 257MS4 | -2 / +8 | 2500x700x970 | 650 | 230V - 50Hz | 209 | 0,50 | R134A | 430                         | - |

R290 R290 İstenildiği takdirde fiyatlara %3 ilave edilir. / For R290 Refrigerant gas, price increase is 3%.

## TEKNİK DETAYLAR / TECHNICAL DETAILS

TR

- Dış ortam sıcaklığı +43°C %65 nem oranı
- Eşit sıcaklık dağılımı için yeni tasarım
- Sıfır ODP enjekte 42 kg/m<sup>3</sup> çevre dostu poliüretan izolasyon
- Kolay okunur ekranlı dijital kontrol
- Ergonomik kapı ve kulpu sayesinde kolay açılma ve temizlik
- Patentli 'Icecool' soğutma sistemi ile mükemmel verim ve enerji sarfiyatı
- Sıcak gaz defrost sistemi
- Atık ısı geri kazanımlı kondanzasyon
- Tüm buzdolapların marine versiyonları mevcuttur.
- 14 Adet 1/4-100 Gn kapasitesi.

EN

- Designed to operate in 43°C ambient %65 humidity
- New design for equal temperature distribution
- Zero ODP Injected 42 kg/m<sup>3</sup> Polyurethane Insulation
- Digital controller with easy read screen
- Ergonomic door and handle designed for ease of opening and cleaning
- Icecool refrigeration system designed to be most technologically advanced and energy efficient yet
- Hot gas defrost system
- Waste heat recovery condensate vaporiser system
- All refrigerators can be produced in marine version
- 14 No's 1/4-100mm Gn capacity

AIM 257MS

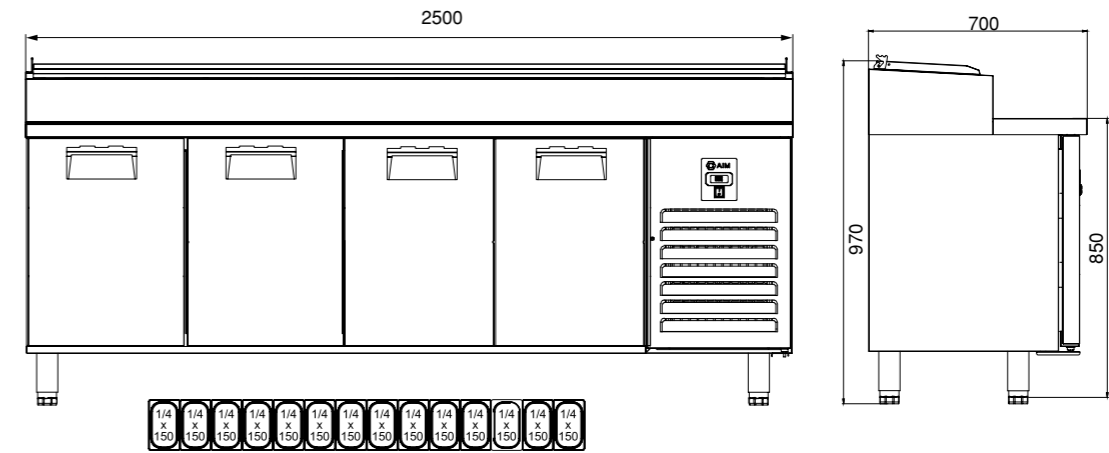

## OPSIYONLAR / OPTIONS

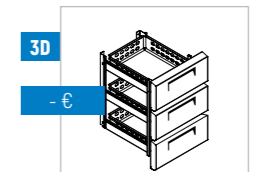
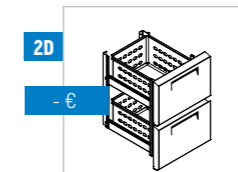
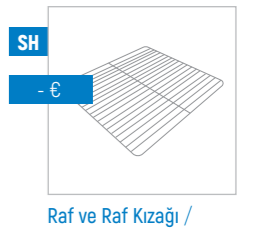
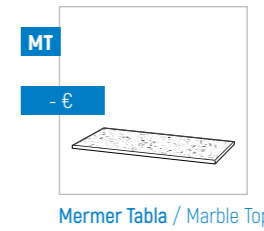
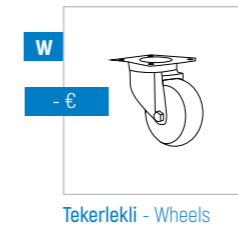
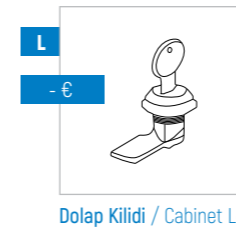
Gastronom küvetler fiyata dahil değildir.  
Gn containers are not included in the price.

1/2 Çekmece - 1/2 Drawers

1/3 Çekmece - 1/3 Drawers

Sol Motor / Left Motor

AIM

## AIM 157SB

MAKE UP BUZDOLAPLARI - MERMERLİ  
MAKE UP REFRIGERATORS - W/MARBLE

## TEKNİK DETAYLAR / TECHNICAL DETAILS

TR

- Dış ortam sıcaklığı +43°C %65 nem oranı
- Eşit sıcaklık dağılımı için yeni tasarım
- Sıfır ODP enjekte 42 kg/m<sup>3</sup> çevre dostu poliüretan izolasyon
- Kolay okunur ekranlı dijital kontrol
- Ergonomik kapı ve kulpu sayesinde kolay açılma ve temizlik
- Patentli 'Icecool' soğutma sistemi ile mükemmel verim ve enerji sarfiyatı
- Sıcak gaz defrost sistemi
- Atık ısı geri kazanımlı kondanzasyon
- Tüm buzdolapların marine versiyonları mevcuttur.

EN

- Designed to operate in 43°C ambient %65 humidity
- New design for equal temperature distribution
- Zero ODP Injected 42 kg/m<sup>3</sup> Polyurethane Insulation
- Digital controller with easy read screen
- Ergonomic door and handle designed for ease of opening and cleaning
- Icecool refrigeration system designed to be most technologically advanced and energy efficient yet
- Hot gas defrost system
- Waste heat recovery condensate vaporiser system
- All refrigerators can be produced in marine version

## AIM 157SB

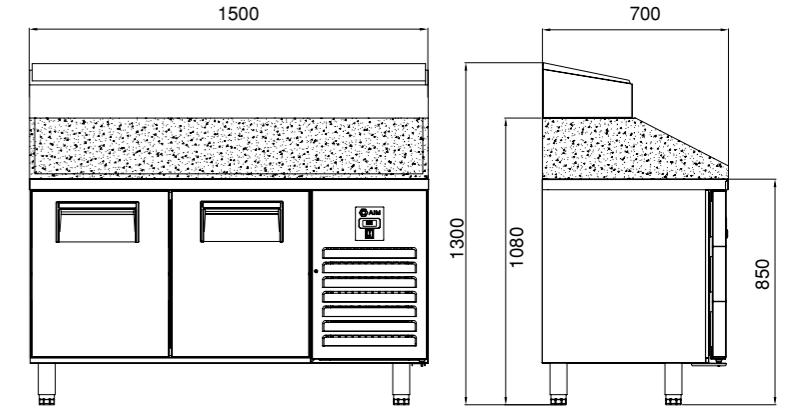
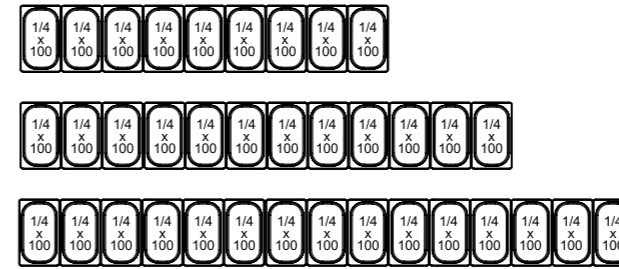

## OPSİYONLAR / OPTIONS

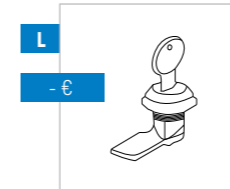
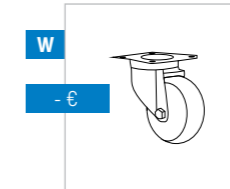
Dolap Kilidi /  
Cabinet Lock

Tekerlekli - Wheels

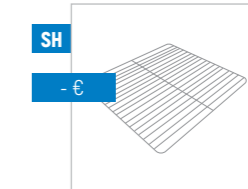
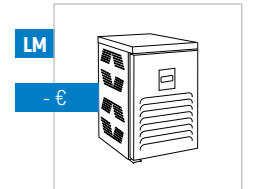
Raf ve Raf Kızağı /  
Shelf and Shelf Holder

Sol Motor / Left Motor

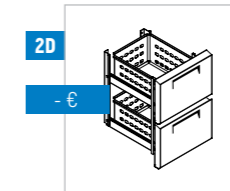
Gastronom küvetler fiyata dahil değildir.  
Gn containers are not included in the price.

1/2 Çekmece - 1/2 Drawers

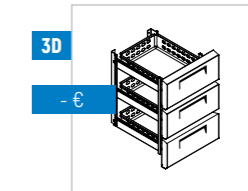

1/3 Çekmece - 1/3 Drawers

| KOD / CODE   | °C      | (MM)             | It  | 230V - 50Hz | kg  | (kW)  | R134A | GN 1/4-150 | PASLANMAZ TİPİ S.S. TYPE | € |
|--------------|---------|------------------|-----|-------------|-----|-------|-------|------------|--------------------------|---|
| AIM 157M3-SB | -2 / +8 | 1500x700x850/140 | 330 | 230V - 50Hz | 146 | 0,321 | R134A | 9          | 304                      | - |
| AIM 157M4-SB | -2 / +8 | 1500x700x850/140 | 330 | 230V - 50Hz | 146 | 0,321 | R134A | 9          | 430                      | - |
| AIM 207M3-SB | -2 / +8 | 2000x700x850/140 | 515 | 230V - 50Hz | 247 | 0,336 | R134A | 12         | 304                      | - |
| AIM 207M4-SB | -2 / +8 | 2000x700x850/140 | 515 | 230V - 50Hz | 247 | 0,336 | R134A | 12         | 430                      | - |
| AIM 257M3-SB | -2 / +8 | 2500x700x850/140 | 650 | 230V - 50Hz | 262 | 0,501 | R134A | 15         | 304                      | - |
| AIM 257M4-SB | -2 / +8 | 2500x700x850/140 | 650 | 230V - 50Hz | 262 | 0,501 | R134A | 15         | 430                      | - |

R290 R290 İstenildiği takdirde fiyatlara %3 ilave edilir. / For R290 Refrigerant gas, price increase is 3%.

AIM

## AIM 158 40X60

MAKE UP BUZDOLAPLARI - MERMERLİ  
MAKE UP REFRIGERATORS - W/MARBLE

150 GL

Setüstü saladbar fiyatı ayrıca belirtilmiştir.  
Saladbar price is extra

158M4



## TEKNİK DETAYLAR / TECHNICAL DETAILS

TR

- Dış ortam sıcaklığı +43°C %65 nem oranı
- Eşit sıcaklık dağılımı için yeni tasarım
- Sıfır ODP enjekte 42 kg/m<sup>3</sup> çevre dostu poliüretan izolasyon
- Kolay okunur ekranlı dijital kontrol
- Ergonomik kapı ve kulpu sayesinde kolay açılma ve temizlik
- Patentli 'Icecool' soğutma sistemi ile mükemmel verim ve enerji sarfiyatı
- Sıcak gaz defrost sistemi
- Atık ısı geri kazanımlı kondansasyon
- Tüm buzdolapların marine versiyonları mevcuttur.

EN

- Designed to operate in 43°C ambient %65 humidity
- New design for equal temperature distribution
- Zero ODP Injected 42 kg/m<sup>3</sup> Polyurethane Insulation
- Digital controller with easy read screen
- Ergonomic door and handle designed for ease of opening and cleaning
- Icecool refrigeration system designed to be most technologically advanced and energy efficient yet
- Hot gas defrost system
- Waste heat recovery condensate vaporiser system
- All refrigerators can be produced in marine version

## AIM 158 40X60

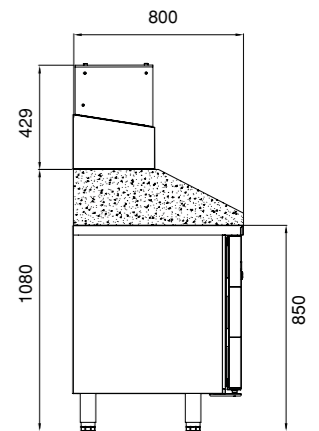
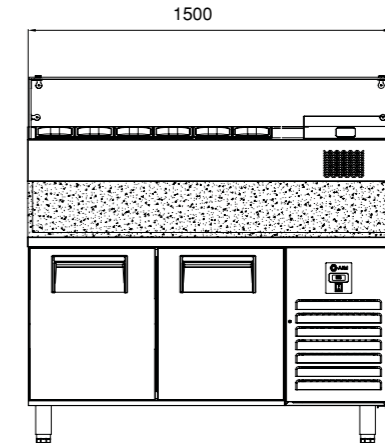
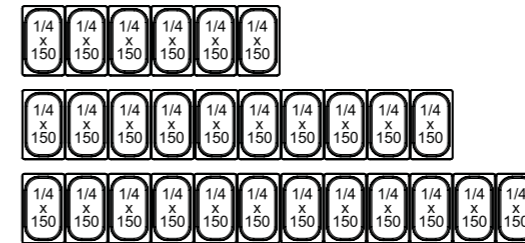

## OPSİYONLAR / OPTIONS

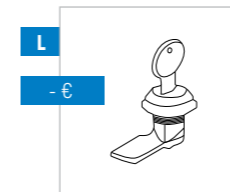

- €

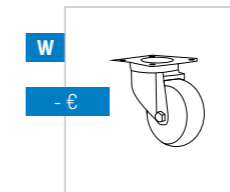

- €

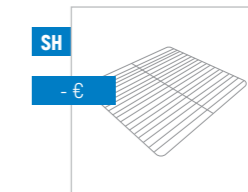

- €

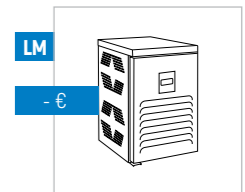

- €

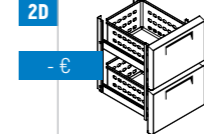

- €

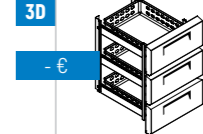

- €

Gastronom küvetler fiyata dahil değildir.  
Gn containers are not included in the price.

1/2 Çekmece - 1/2 Drawers

1/3 Çekmece - 1/3 Drawers

| KOD / CODE | °C      | (MM)               | lt  | 230V - 50Hz | kg  | (KW)  | R134A | GN 1/4-150 | PASLANMAZ TİPİ S.S. TYPE | € |
|------------|---------|--------------------|-----|-------------|-----|-------|-------|------------|--------------------------|---|
| AIM 158M3  | -2 / +8 | 1500x800x1080/1500 | 330 | 230V - 50Hz | 146 | 0,321 | R134A | 6          | 304                      | - |
| AIM 158M4  | -2 / +8 | 1500x800x1080/1500 | 330 | 230V - 50Hz | 146 | 0,321 | R134A | 6          | 430                      | - |
| AIM 208M3  | -2 / +8 | 2000x800x1080/1500 | 515 | 230V - 50Hz | 247 | 0,336 | R134A | 10         | 304                      | - |
| AIM 208M4  | -2 / +8 | 2000x800x1080/1500 | 515 | 230V - 50Hz | 247 | 0,336 | R134A | 10         | 430                      | - |
| AIM 150 GL | -2 / +8 | 1500x340x440       | -   | 230V - 50Hz | 247 | 0,2   | R134A | 6          | 430                      | - |
| AIM 200 GL | -2 / +8 | 2000x340x440       | -   | 230V - 50Hz | 247 | 0,2   | R134A | 10         | 430                      | - |
| AIM 250 GL | -2 / +8 | 2500x340x440       | -   | 230V - 50Hz | 262 | 0,2   | R134A | 12         | 430                      | - |

R290 İstenildiği takdirde fiyatlara %3 ilave edilir. / For R290 Refrigerant gas, price increase is 3%.



# AIM SB-PL-GL

SETÜSTÜ SALADBARLAR  
COUNTERTOP SALADBAR

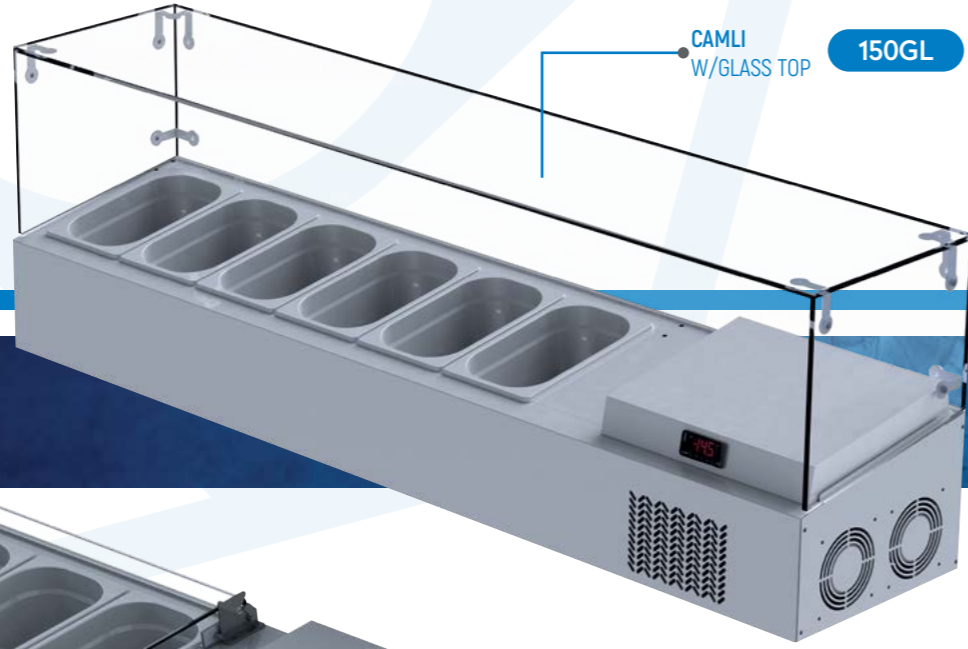

CAMLI  
W/GLASS TOP

150GL

132 PL  
PLEKSİ KAPAK  
PLEXY COVER



| KOD / CODE | 🌡️      | 📏<br>[MM]    | 🔌           | 📊  | ⚡<br>[KW] | GN<br>1/4-150 | € |
|------------|---------|--------------|-------------|----|-----------|---------------|---|
| AIM 132 GL | -2 / +8 | 1320x340x450 | 230V - 50Hz | 34 | 0,2 kW    | 5             | - |
| AIM 150 GL | -2 / +8 | 1500x340x450 | 230V - 50Hz | 36 | 0,2 kW    | 6             | - |
| AIM 178 GL | -2 / +8 | 1780x340x450 | 230V - 50Hz | 42 | 0,2 kW    | 8             | - |
| AIM 200 GL | -2 / +8 | 2000x340x450 | 230V - 50Hz | 45 | 0,2 kW    | 10            | - |
| AIM 225 GL | -2 / +8 | 2250x340x450 | 230V - 50Hz | 53 | 0,2 kW    | 11            | - |
| AIM 250 GL | -2 / +8 | 2500x340x450 | 230V - 50Hz | 55 | 0,2 kW    | 12            | - |
| AIM 132 PL | -2 / +8 | 1320x340x300 | 230V - 50Hz | 34 | 0,2 kW    | 5             | - |
| AIM 150 PL | -2 / +8 | 1500x340x300 | 230V - 50Hz | 36 | 0,2 kW    | 6             | - |
| AIM 178 PL | -2 / +8 | 1780x340x300 | 230V - 50Hz | 42 | 0,2 kW    | 8             | - |
| AIM 200 PL | -2 / +8 | 2000x340x300 | 230V - 50Hz | 45 | 0,2 kW    | 10            | - |
| AIM 225 PL | -2 / +8 | 2250x340x300 | 230V - 50Hz | 53 | 0,2 kW    | 11            | - |
| AIM 250 PL | -2 / +8 | 2500x340x300 | 230V - 50Hz | 55 | 0,2 kW    | 12            | - |

R290 R290 İstenildiği takdirde fiyatlara %3 ilave edilir. / For R290 Refrigerant gas, price increase is 3%.

## TEKNİK DETAYLAR / TECHNICAL DETAILS

TR

- Dış ortam sıcaklığı +43°C %65 nem oranı
- Eşit sıcaklık dağılımı için yeni tasarım
- Sıfır ODP enjekte 42 kg/m<sup>3</sup> çevre dostu poliüretan izolasyon
- Kolay okunur ekranlı dijital kontrol
- Ergonomik kapı ve kulpu sayesinde kolay açılma ve temizlik
- Patentli 'Icecool' soğutma sistemi ile mükemmel verim ve enerji sarfiyatı
- Sıcak gaz defrost sistemi
- Atık ısı geri kazanımlı kondanzasyon
- Tüm buzdolapların marine versiyonları mevcuttur.
- 14 Adet 1/4-100 Gn kapasitesi.

EN

- Designed to operate in 43°C ambient %65 humidity
- New design for equal temperature distribution
- Zero ODP Injected 42 kg/m<sup>3</sup> Polyurethane Insulation
- Digital controller with easy read screen
- Ergonomic door and handle designed for ease of opening and cleaning
- Icecool refrigeration system designed to be most technologically advanced and energy efficient yet
- Hot gas defrost system
- Waste heat recovery condensate vaporiser system
- All refrigerators can be produced in marine version
- 14 No's 1/4-100mm Gn capacity

# AIM SB-PL-GL

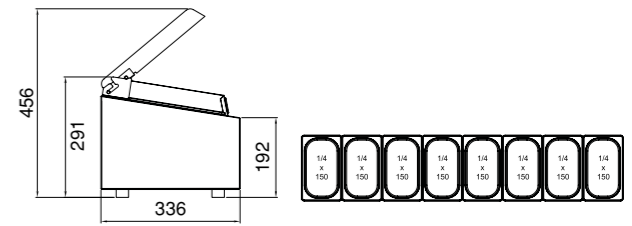
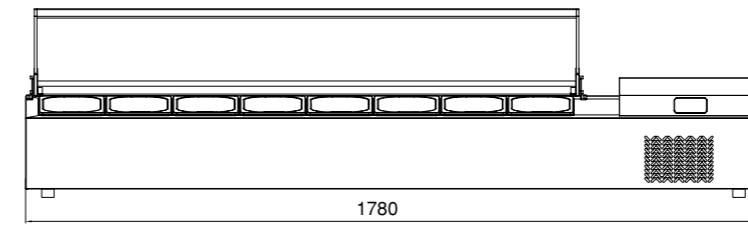
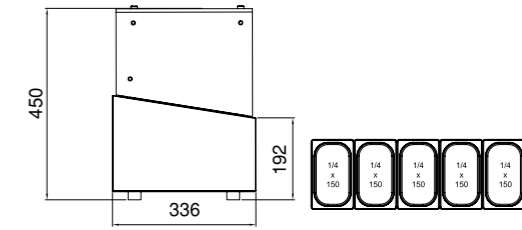
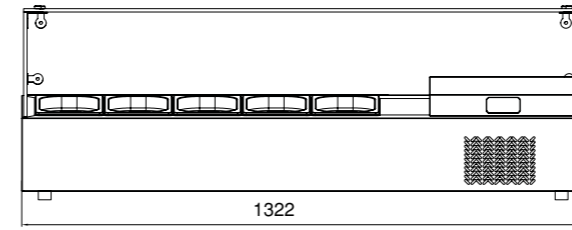

## OPSIYONLAR / OPTIONS



Gastronom küvetler fiyata dahil değildir.  
Gn containers are not included in the price.

# ÖZEL SERİ SOĞUTUCULAR

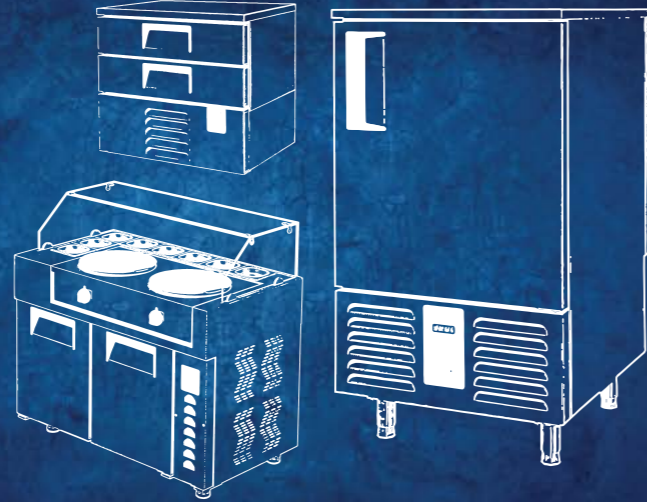

## SPECIAL COLDLINE

### YENİ KONDENSER SİSTEMİ NEW CONDENSER SYSTEM



CLASSIC



AIMCLEAR

Temizlik gerektirmeyen kondenser  
Stayclear Condenser

### ENERJİ TASARRUFU SAVING ENERGY



Düşük enerji tüketimi sağlayan çevre dostu HFC içermeyen poliüretan izolasyon  
Eco friendly, HFC - free polyurethane insulation providing low energy consumption

### SICAK GAZ DEFROST İLE KARLANMAYAN EVAPARATÖR EVAPARATOR DOES NOT SNOW THROUGH HOT GAS DEFROST



CLASSIC

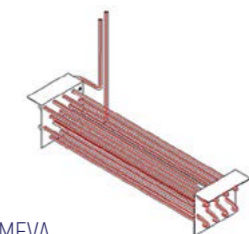

AIMEVA

AIM

# AIM 21DR / 11DR

ÇEKMECELİ SOĞUTUCU VE DONDURUCULAR  
DRAWER TYPE COOLING & FREEZING UNITS

21DR

11DR



## TEKNİK DETAYLAR / TECHNICAL DETAILS

TR

- Dış ortam sıcaklığı +43°C %65 nem oranı
- Eşit sıcaklık dağılımı için yeni tasarım
- Sıfır ODP enjekte 42 kg/m<sup>3</sup> çevre dostu poliüretan izolasyon
- Kolay okunur ekranlı dijital kontrol
- Ergonomik kapı ve kulpu sayesinde kolay açılma ve temizlik
- Patentli 'Icecool' soğutma sistemi ile mükemmel verim ve enerji sarfiyatı
- Sıcak gaz defrost sistemi
- Atık ısı geri kazanımlı kondansasyon
- Tüm buzdolapların marine versiyonları mevcuttur.
- Marine versiyonları 'Icecool marine' sistemi, marine ayak ve raflar içerir.

EN

- Designed to operate in 43°C ambient %65 humidity
- New design for equal temperature distribution
- Zero ODP Injected 42 kg/m<sup>3</sup> Polyurethane Insulation
- Digital controller with easy read screen
- Ergonomic door and handle designed for ease of opening and cleaning
- Icecool refrigeration system designed to be most technologically advanced and energy efficient yet
- Hot gas defrost system
- Waste heat recovery condensate vaporiser system
- All refrigerators can be produced in marine version
- Marine version includes 'Icecool marine' system, legs and shelves

## AIM 21DR / 11DR

11DR

21DR

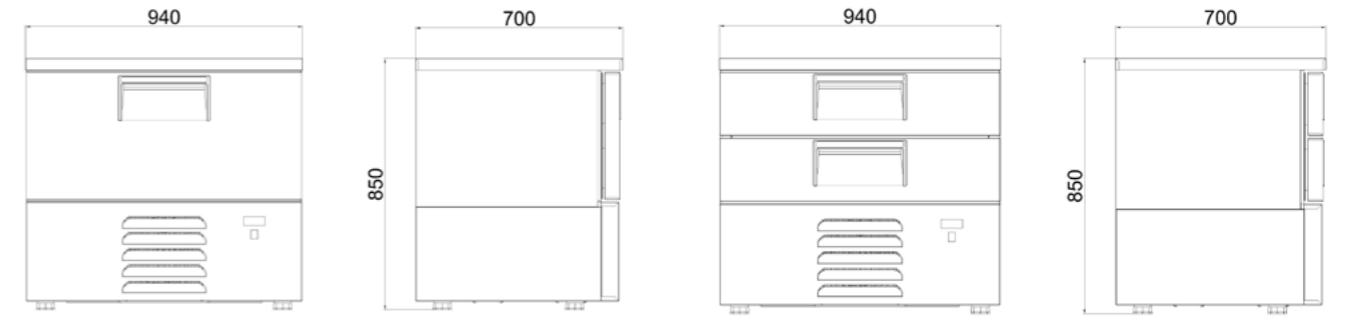

## OPSİYONLAR / OPTIONS

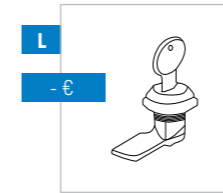

L  
- €  
Dolap Kilidi /  
Cabinet Lock

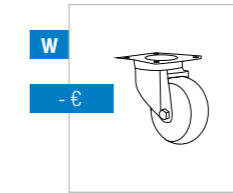

W  
- €  
Tekirlekli - Wheels

| KOD / CODE | °C      | MM          | 230V - 50Hz | kg  | (KW) | R290 | KAPASİTE<br>CAPACITY<br>GN 2/1-100 | KAPASİTE<br>CAPACITY<br>GN 2/1-200 | PASLANMAZ TİPİ<br>S.S. TYPE | € |
|------------|---------|-------------|-------------|-----|------|------|------------------------------------|------------------------------------|-----------------------------|---|
| AIM 21DR3  | +8 /-20 | 940x700x850 | 230V - 50Hz | 153 | 0,90 | R290 | 2                                  | -                                  | 304                         | - |
| AIM 21DR4  | +8 /-20 | 940x700x850 | 230V - 50Hz | 153 | 0,90 | R290 | 2                                  | -                                  | 430                         | - |
| AIM 11DR3  | +8 /-20 | 940x700x850 | 230V - 50Hz | 178 | 0,90 | R290 | -                                  | 1                                  | 304                         | - |
| AIM 11DR4  | +8 /-20 | 940x700x850 | 230V - 50Hz | 178 | 0,90 | R290 | -                                  | 1                                  | 430                         | - |

R290 İstenildiği takdirde fiyatlara %3 ilave edilir. / For R290 Refrigerant gas, price increase is 3%.

AIM

# AIM 800 USA

ÇEKMECELİ PİZZA HAZIRLIK BUZDOLABI  
DRAWER TYPE PIZZA PREPERATION COUNTER

12X1/3 - 100 GN  
KAPASİTESİ

12X1/3 - 100 GN  
CAPACITY

İZOLASYONLU ÜST  
KAPAK

INSULATED TOP  
COVER

2/1 - 200 GN  
KAPASİTESİ

2/1 - 200 GN  
CAPACITY



## TEKNİK DETAYLAR / TECHNICAL DETAILS

TR

- Dış ortam sıcaklığı +43°C %65 nem oranı
- Eşit sıcaklık dağılımı için yeni tasarım
- Sıfır ODP enjekte 42 kg/m3 çevre dostu poliüretan izolasyon
- Kolay okunur ekranlı dijital kontrol
- Ergonomik kapı ve kulpu sayesinde kolay açılma ve temizlik
- Patentli 'Icecool' soğutma sistemi ile mükemmel verim ve enerji sarfiyatı
- Sıcak gaz defrost sistemi
- Atık ısı geri kazanımlı kondanzasyon
- **12 Adet 1/3-100 Gn saladbar kapasitesi**
- **6 Adet 2/1 Gn kapasitesi.**

EN

- Designed to operate in 43°C ambient %65 humidity
- New design for equal temperature distribution
- Zero ODP Injected 42 kg/m3 Polyurethane Insulation
- Digital controller with easy read screen
- Ergonomic door and handle designed for ease of opening and cleaning
- Icecool refrigeration system designed to be most technologically advanced and energy efficient yet
- Hot gas defrost system
- Waste heat recovery condensate vaporiser system
- **12 No's 1/3-100 Gn saladbar capacity**
- **6 No's 2/1 Gn capacity.**

# AIM 800 USA

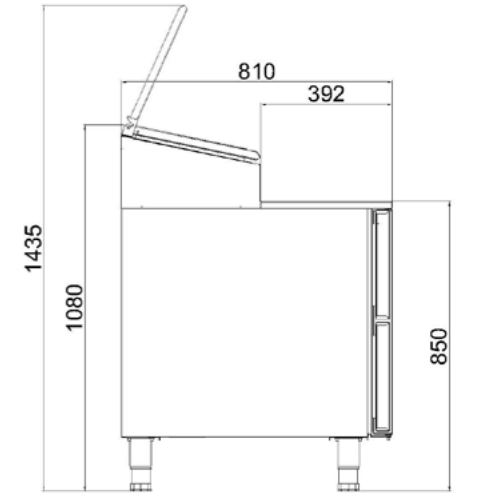
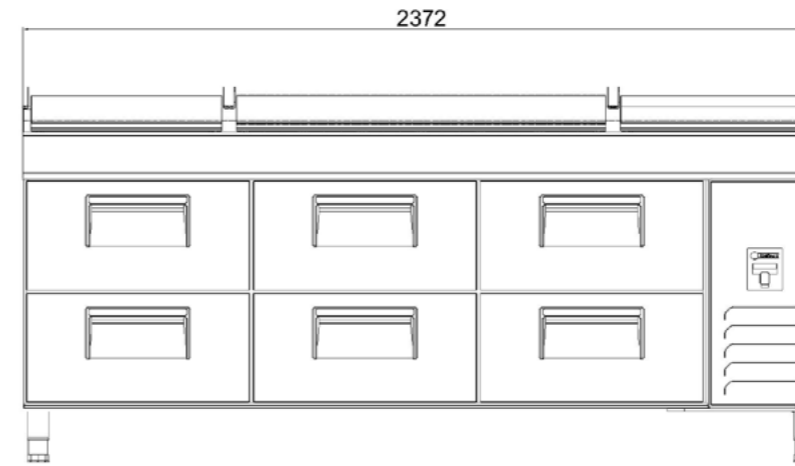

## OPSİYONLAR / OPTIONS

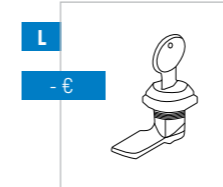

- €

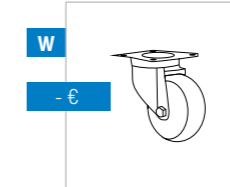

- €

| KOD / CODE   | °C      | (MM)          | lt  | 230V - 50Hz | kg  | (KW) | R134A | KAPASİTE<br>CAPACITY<br>GN 2/1-200 | PASLANMAZ TİPİ<br>S.S. TYPE | € |
|--------------|---------|---------------|-----|-------------|-----|------|-------|------------------------------------|-----------------------------|---|
| AIM 800USA-3 | -2 / +8 | 2372x810x1090 | 800 | 230V - 50Hz | 250 | 0,76 | R134A | 6                                  | 304                         | - |
| AIM 800USA-4 | -2 / +8 | 2372x810x1090 | 800 | 230V - 50Hz | 250 | 0,76 | R134A | 6                                  | 430                         | - |

R290 istenildiği takdirde fiyatlara %3 ilave edilir. / For R290 Refrigerant gas, price increase is 3%.



## TEKNİK DETAYLAR / TECHNICAL DETAILS

## TR

- Dış ortam sıcaklığı +43°C %65 nem oranı
- Eşit sıcaklık dağılımı için yeni tasarım
- Sıfır ODP enjekte 42 kg/m<sup>3</sup> çevre dostu poliüretan izolasyon
- Kolay okunur ekranlı dijital kontrol
- Ergonomik kapı ve kulpu sayesinde kolay açılma ve temizlik
- Patentli 'Icecool' soğutma sistemi ile mükemmel verim ve enerji sarfiyatı
- Sıcak gaz defrost sistemi
- Atık ısı geri kazanımlı kondanzasyon
- Tüm buzdolapların marine versiyonları mevcuttur.
- Marine versiyonları 'Icecool marine' sistemi, marine ayak ve raflar içerir.

## EN

- Designed to operate in 43°C ambient %65 humidity
- New design for equal temperature distribution
- Zero ODP Injected 42 kg/m<sup>3</sup> Polyurethane Insulation
- Digital controller with easy read screen
- Ergonomic door and handle designed for ease of opening and cleaning
- Icecool refrigeration system designed to be most technologically advanced and energy efficient yet
- Hot gas defrost system
- Waste heat recovery condensate vaporiser system
- All refrigerators can be produced in marine version
- Marine version includes 'Icecool marine' system, legs and shelves

## SBR/G 04-05-07

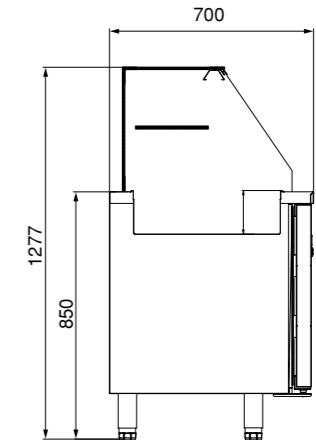
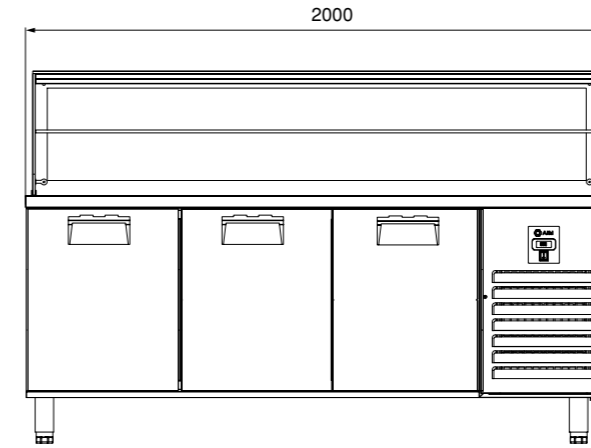

| KOD / CODE   | °C      | (MM)              | lit | Power       | kg  | (kW) | R134A | KAPASİTE CAPACITY GN 1/1-150 | PASLANMAZ TİPİ S.S. TYPE | € |
|--------------|---------|-------------------|-----|-------------|-----|------|-------|------------------------------|--------------------------|---|
| AIM 15SBR3-G | -2 / +8 | 1500x700x850/1230 | 330 | 230V - 50Hz | 153 | 0,32 | R134A | 4                            | 304                      | - |
| AIM 15SBR4-G | -2 / +8 | 1500x700x850/1230 | 330 | 230V - 50Hz | 153 | 0,32 | R134A | 4                            | 430                      | - |
| AIM 20SBR3-G | -2 / +8 | 2000x700x850/1230 | 515 | 230V - 50Hz | 178 | 0,34 | R134A | 5                            | 304                      | - |
| AIM 20SBR4-G | -2 / +8 | 2000x700x850/1230 | 515 | 230V - 50Hz | 178 | 0,34 | R134A | 5                            | 430                      | - |
| AIM 25SBR3-G | -2 / +8 | 2500x700x850/1230 | 650 | 230V - 50Hz | 195 | 0,50 | R134A | 6                            | 304                      | - |
| AIM 25SBR4-G | -2 / +8 | 2500x700x850/1230 | 650 | 230V - 50Hz | 195 | 0,50 | R134A | 6                            | 430                      | - |

R290 İstenildiği takdirde fiyatlara %3 ilave edilir. / For R290 Refrigerant gas, price increase is 3%.

## OPSİYONLAR / OPTIONS

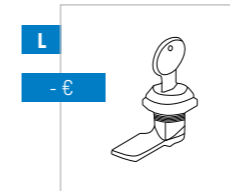

Dolap Kilidi / Cabinet Lock

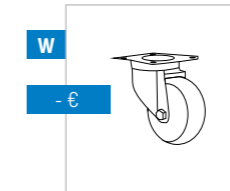

Tekerlekli - Wheels

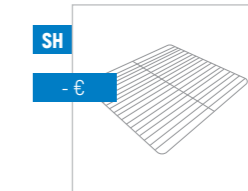

Raf ve Raf Kızağı / Shelf and Shelf Holder

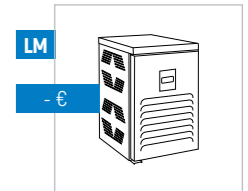

Sol Motor / Left Motor



1/1-150mm

Gastronom küvetler fiyata dahil değildir. Gn containers are not included in the price.

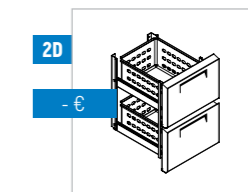

1/2 Çekmece - 1/2 Drawers

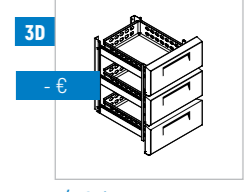

1/3 Çekmece - 1/3 Drawers



## TEKNİK DETAYLAR / TECHNICAL DETAILS

## TR

- Dış ortam sıcaklığı +43°C %65 nem oranı
- Eşit sıcaklık dağılımı için yeni tasarım
- Sıfır ODP enjekte 42 kg/m<sup>3</sup> çevre dostu poliüretan izolasyon
- Kolay okunur ekranlı dijital kontrol
- Ergonomik kapı ve kulpu sayesinde kolay açılma ve temizlik
- Patentli 'Icecool' soğutma sistemi ile mükemmel verim ve enerji sarfiyatı
- Sıcak gaz defrost sistemi
- Atık ısı geri kazanımlı kondanzasyon
- Tüm buzdolapların marine versiyonları mevcuttur.
- Marine versiyonları 'Icecool marine' sistemi, marine ayak ve raflar içerir.

## EN

- Designed to operate in 43°C ambient %65 humidity
- New design for equal temperature distribution
- Zero ODP Injected 42 kg/m<sup>3</sup> Polyurethane Insulation
- Digital controller with easy read screen
- Ergonomic door and handle designed for ease of opening and cleaning
- Icecool refrigeration system designed to be most technologically advanced and energy efficient yet
- Hot gas defrost system
- Waste heat recovery condensate vaporiser system
- All refrigerators can be produced in marine version
- Marine version includes 'Icecool marine' system, legs and shelves

SBR 04-05-07

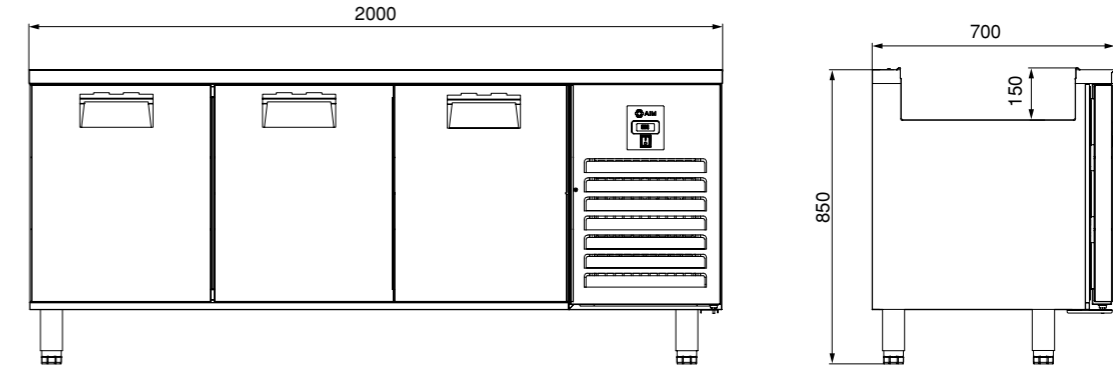

| KOD / CODE | °C      | (MM)         | lt  | 230V - 50Hz | kg  | (kW) | R134A | KAPASİTE CAPACITY GN 1/1-150 | PASLANMAZ TİPİ S.S. TYPE | € |
|------------|---------|--------------|-----|-------------|-----|------|-------|------------------------------|--------------------------|---|
| AIM 15SBR3 | -2 / +8 | 1500x700x850 | 330 | 230V - 50Hz | 153 | 0,32 | R134A | 4                            | 304                      | - |
| AIM 15SBR4 | -2 / +8 | 1500x700x850 | 330 | 230V - 50Hz | 153 | 0,32 | R134A | 4                            | 430                      | - |
| AIM 20SBR3 | -2 / +8 | 2000x700x850 | 515 | 230V - 50Hz | 178 | 0,34 | R134A | 5                            | 304                      | - |
| AIM 20SBR4 | -2 / +8 | 2000x700x850 | 515 | 230V - 50Hz | 178 | 0,34 | R134A | 5                            | 430                      | - |
| AIM 25SBR3 | -2 / +8 | 2500x700x850 | 650 | 230V - 50Hz | 195 | 0,50 | R134A | 6                            | 304                      | - |
| AIM 25SBR4 | -2 / +8 | 2500x700x850 | 650 | 230V - 50Hz | 195 | 0,50 | R134A | 6                            | 430                      | - |

R290 İstenildiği takdirde fiyatlara %3 ilave edilir. / For R290 Refrigerant gas, price increase is 3%.

## OPSIYONLAR / OPTIONS

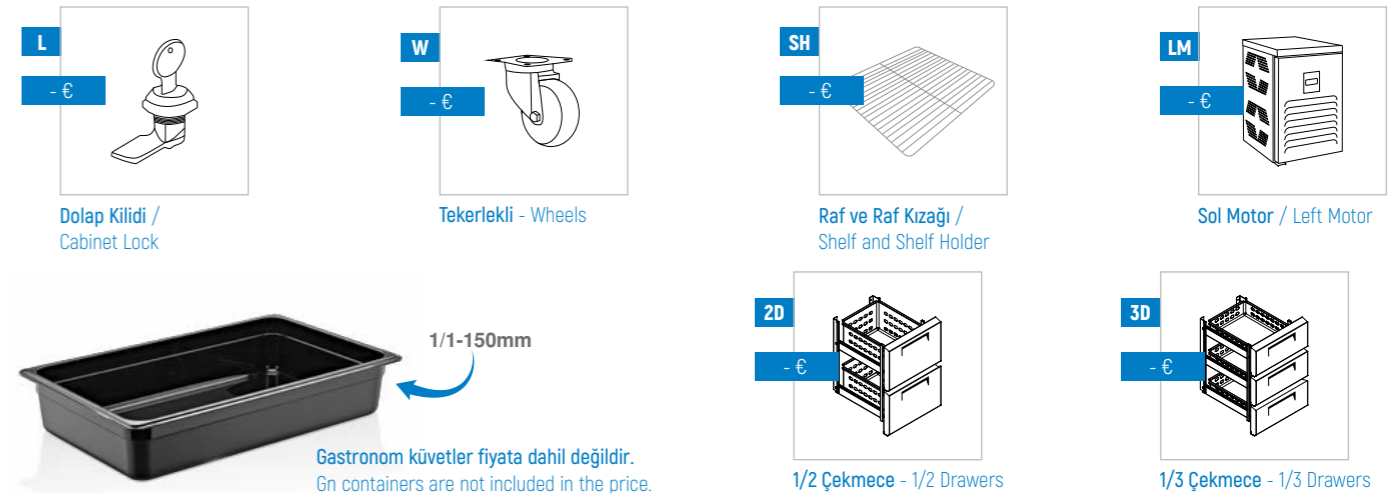

## 156DP/G-157DP/G

TEZGAH TİP BUZDOLAPLARI - ÖNÜ CAMLI  
COUNTER TYPE REFRIGERATORS - W/FRONT GLASS



## TEKNİK DETAYLAR / TECHNICAL DETAILS

## TR

- Dış ortam sıcaklığı +43°C %65 nem oranı
- Eşit sıcaklık dağılımı için yeni tasarım
- Sıfır ODP enjekte 42 kg/m<sup>3</sup> çevre dostu poliüretan izolasyon
- Kolay okunur ekranlı dijital kontrol
- Ergonomik kapı ve kulpu sayesinde kolay açılma ve temizlik
- Patentli 'Icecool' soğutma sistemi ile mükemmel verim ve enerji sarfiyatı
- Sıcak gaz defrost sistemi
- Atık ısı geri kazanımlı kondanzasyon
- Tüm buzdolapların marine versiyonları mevcuttur.

## EN

- Designed to operate in 43°C ambient %65 humidity
- New design for equal temperature distribution
- Zero ODP Injected 42 kg/m<sup>3</sup> Polyurethane Insulation
- Digital controller with easy read screen
- Ergonomic door and handle designed for ease of opening and cleaning
- Icecool refrigeration system designed to be most technologically advanced and energy efficient yet
- Hot gas defrost system
- Waste heat recovery condensate vaporiser system
- All refrigerators can be produced in marine version

## 156DP/G - 157DP/G

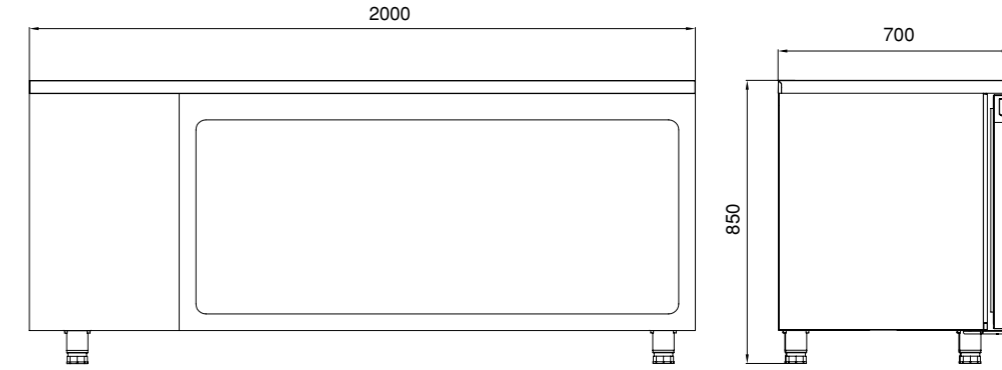

| KOD / CODE   | 🌡️        | 📏<br>(MM)    | 📦<br>lt | 🔌           | 📊<br>kg | ⚡<br>(KW) | PASLANMAZ TİPİ<br>S.S. TYPE | € |
|--------------|-----------|--------------|---------|-------------|---------|-----------|-----------------------------|---|
| AIM 156DP3-G | - 2 / + 8 | 1500x600x850 | 275     | 230V - 50Hz | 103     | 0,321     | 304                         | - |
| AIM 156DP4-G | - 2 / + 8 | 1500x600x850 | 275     | 230V - 50Hz | 103     | 0,321     | 430                         | - |
| AIM 157DP3-G | - 2 / + 8 | 1500x700x850 | 330     | 230V - 50Hz | 107     | 0,321     | 304                         | - |
| AIM 157DP4-G | - 2 / + 8 | 1500x700x850 | 330     | 230V - 50Hz | 107     | 0,321     | 430                         | - |
| AIM 206DP3-G | - 2 / + 8 | 2000x600x850 | 440     | 230V - 50Hz | 132     | 0,336     | 304                         | - |
| AIM 206DP4-G | - 2 / + 8 | 2000x600x850 | 440     | 230V - 50Hz | 132     | 0,336     | 430                         | - |
| AIM 207DP3-G | - 2 / + 8 | 2000x700x850 | 515     | 230V - 50Hz | 137     | 0,336     | 304                         | - |
| AIM 207DP4-G | - 2 / + 8 | 2000x700x850 | 515     | 230V - 50Hz | 137     | 0,336     | 430                         | - |
| AIM 256DP3-G | - 2 / + 8 | 2500x600x850 | 560     | 230V - 50Hz | 196     | 0,501     | 304                         | - |
| AIM 256DP4-G | - 2 / + 8 | 2500x600x850 | 560     | 230V - 50Hz | 196     | 0,501     | 430                         | - |
| AIM 257DP3-G | - 2 / + 8 | 2500x700x850 | 650     | 230V - 50Hz | 204     | 0,501     | 304                         | - |
| AIM 257DP4-G | - 2 / + 8 | 2500x700x850 | 650     | 230V - 50Hz | 204     | 0,501     | 430                         | - |

R290 İstenildiği takdirde fiyatlara %3 ilave edilir. / For R290 Refrigerant gas, price increase is 3%.

## OPSIYONLAR / OPTIONS

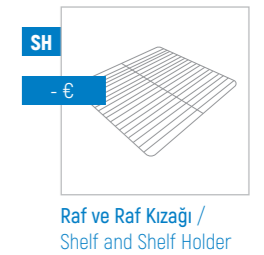
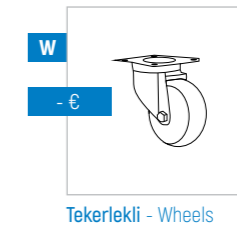
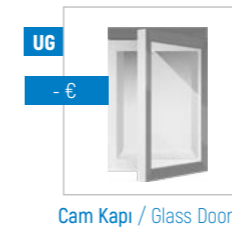
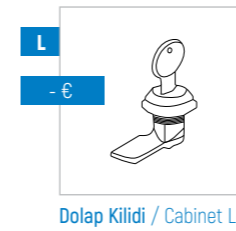

AIM

## AIM CR-127

KREP BUZDOLAPLARI  
CREP TABLE REFRIGERATORS

## TEKNİK DETAYLAR / TECHNICAL DETAILS

TR

- Dış ortam sıcaklığı +43°C %65 nem oranı
- Eşit sıcaklık dağılımı için yeni tasarım
- Sıfır ODP enjekte 42 kg/m<sup>3</sup> çevre dostu poliüretan izolasyon
- Kolay okunur ekranlı dijital kontrol
- Ergonomik kapı ve kulpu sayesinde kolay açılma ve temizlik
- Patentli 'Icecool' soğutma sistemi ile mükemmel verim ve enerji sarfıyatı
- Sıcak gaz defrost sistemi
- Atık ısı geri kazanımlı kondanzasyon
- Tüm buzdolapların marine versiyonları mevcuttur.
- **8 Adet 1/4-100 Gn kapasitesi.**

EN

- Designed to operate in 43°C ambient %65 humidity
- New design for equal temperature distribution
- Zero ODP Injected 42 kg/m<sup>3</sup> Polyurethane Insulation
- Digital controller with easy read screen
- Ergonomic door and handle designed for ease of opening and cleaning
- Icecool refrigeration system designed to be most technologically advanced and energy efficient yet
- Hot gas defrost system
- Waste heat recovery condensate vaporiser system
- All refrigerators can be produced in marine version
- **8 No's 1/4-100mm Gn capacity**

AIM CR-127

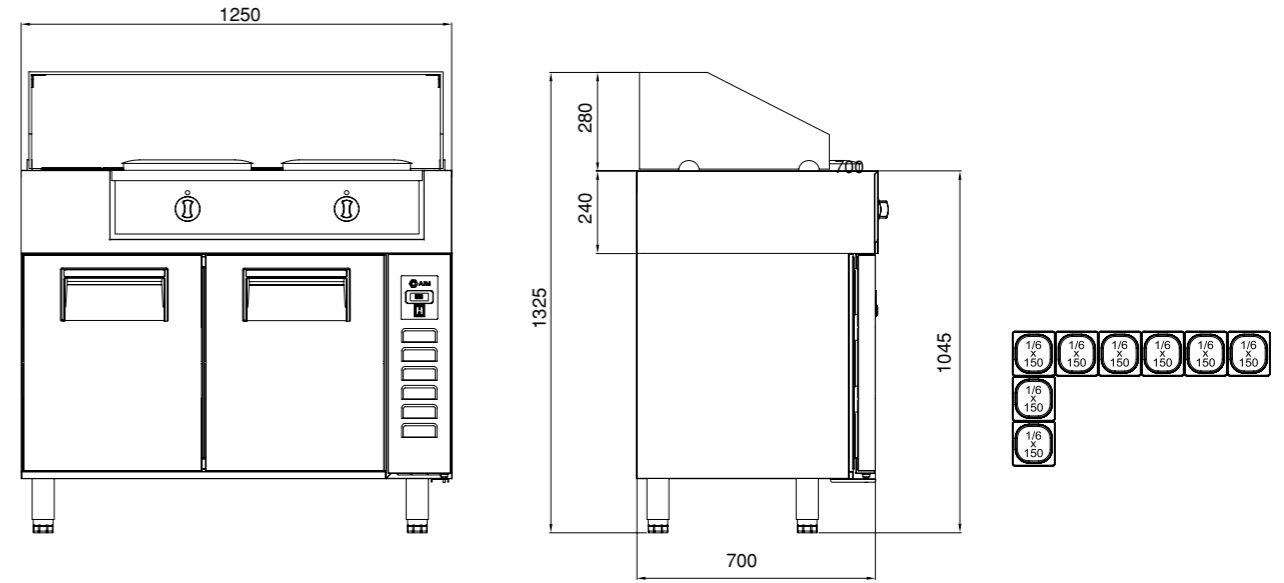

## OPSİYONLAR / OPTIONS

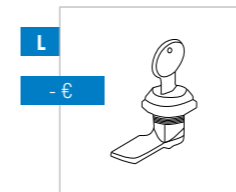

Dolap Kilidi / Cabinet Lock



Cam Kapı / Glass Door

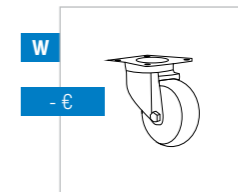

Tekerlekli - Wheels

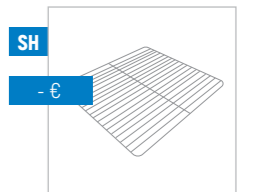
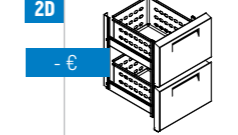
Raf ve Raf Kızağı /  
Shelf and Shelf HolderGastronom kuvvetler fiyata dahil değildir.  
Gn containers are not included in the price.

1/2 Çekmece - 1/2 Drawers

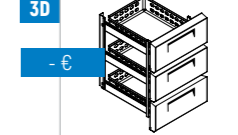

1/3 Çekmece - 1/3 Drawers

| KOD / CODE | °C        | [MM]          | lt  | 230V - 50Hz | kg  | (kW)  | GN 1/6-150 | PASLANMAZ TİPİ S.S. TYPE | € |
|------------|-----------|---------------|-----|-------------|-----|-------|------------|--------------------------|---|
| AIM 127CR3 | - 2 / + 8 | 1250x700x1330 | 330 | 230V - 50Hz | 107 | 0,357 | 8          | 304                      | - |
| AIM 127CR4 | - 2 / + 8 | 1250x700x1330 | 330 | 230V - 50Hz | 107 | 0,357 | 8          | 430                      | - |

R290 istenildiği takdirde fiyatlara %3 ilave edilir. / For R290 Refrigerant gas, price increase is 3%.

AIM

## AIM 157PF

HAZIRLIK BUZDOLAPLARI  
PREPARING TABLE REFRIGERATORS

## TEKNİK DETAYLAR / TECHNICAL DETAILS

TR

- Dış ortam sıcaklığı +43°C %65 nem oranı
- Eşit sıcaklık dağılımı için yeni tasarım
- Sıfır ODP enjekte 42 kg/m<sup>3</sup> çevre dostu poliüretan izolasyon
- Kolay okunur ekranlı dijital kontrol
- Ergonomik kapı ve kulpu sayesinde kolay açılma ve temizlik
- Patentli 'Icecool' soğutma sistemi ile mükemmel verim ve enerji sarfiyatı
- Sıcak gaz defrost sistemi
- Atık ısı geri kazanımlı kondanzasyon
- Tüm buzdolapların marine versiyonları mevcuttur.
- 14 Adet 1/4-100 Gn kapasitesi.

EN

- Designed to operate in 43°C ambient %65 humidity
- New design for equal temperature distribution
- Zero ODP Injected 42 kg/m<sup>3</sup> Polyurethane Insulation
- Digital controller with easy read screen
- Ergonomic door and handle designed for ease of opening and cleaning
- Icecool refrigeration system designed to be most technologically advanced and energy efficient yet
- Hot gas defrost system
- Waste heat recovery condensate vaporiser system
- All refrigerators can be produced in marine version
- 14 No's 1/4-100mm Gn capacity

AIM 157PF

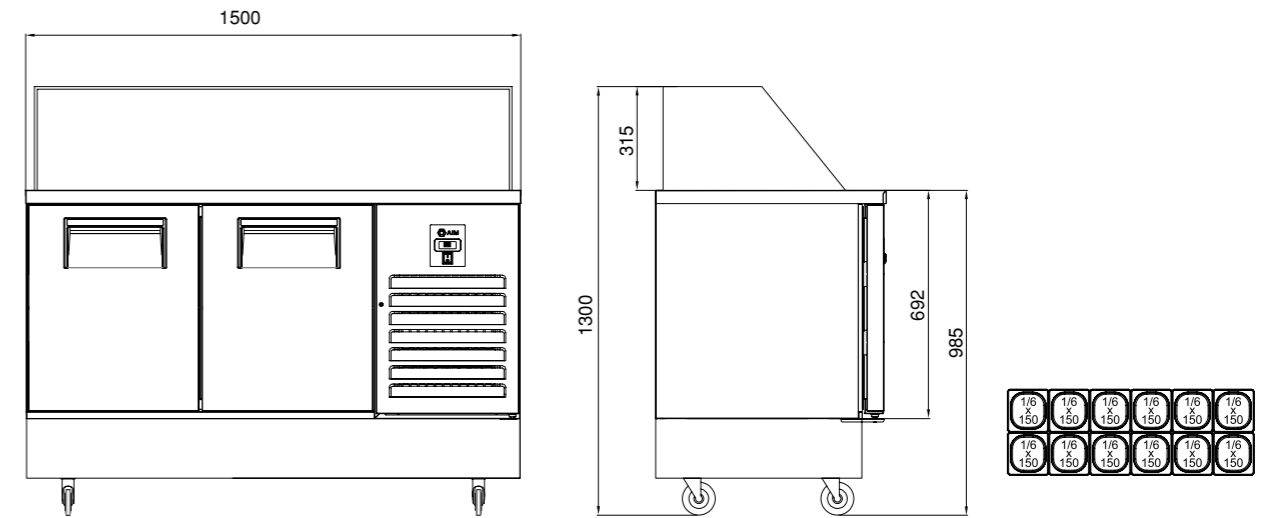

| KOD / CODE | °C      | ↑<br>[MM]     | It  | ⏻           | kg  | ⚡<br>[kW] | GN<br>1/6-150 | PASLANMAZ TİPİ<br>S.S. TYPE | € |
|------------|---------|---------------|-----|-------------|-----|-----------|---------------|-----------------------------|---|
| AIM 157PF3 | -2 / +8 | 1500x700x1300 | 330 | 230V - 50Hz | 135 | 0,357     | 12            | 304                         | - |
| AIM 157PF4 | -2 / +8 | 1500x700x1300 | 330 | 230V - 50Hz | 135 | 0,357     | 12            | 430                         | - |
| AIM 207PF3 | -2 / +8 | 2000x700x1300 | 515 | 230V - 50Hz | 157 | 0,436     | 18            | 304                         | - |
| AIM 207PF4 | -2 / +8 | 2000x700x1300 | 515 | 230V - 50Hz | 157 | 0,436     | 18            | 430                         | - |
| AIM 257PF3 | -2 / +8 | 2500x700x1300 | 650 | 230V - 50Hz | 186 | 0,697     | 24            | 304                         | - |
| AIM 257PF4 | -2 / +8 | 2500x700x1300 | 650 | 230V - 50Hz | 186 | 0,697     | 24            | 430                         | - |

R290 R290 İstenildiği takdirde fiyatlara %3 ilave edilir. / For R290 Refrigerant gas, price increase is 3%.

## OPSIYONLAR / OPTIONS

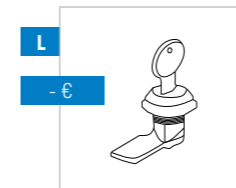

Dolap Kilidi / Cabinet Lock



Cam Kapı / Glass Door

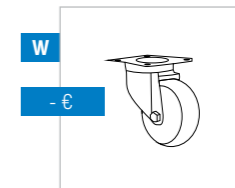

Tekerlekli - Wheels

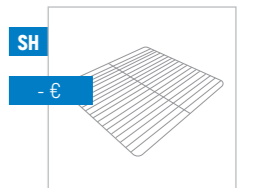
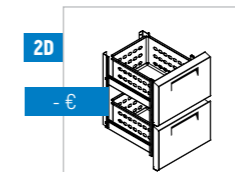
Raf ve Raf Kızağı /  
Shelf and Shelf HolderGastronom kuvvetler fiyata dahil değildir.  
Gn containers are not included in the price.

1/2 Çekmece - 1/2 Drawers

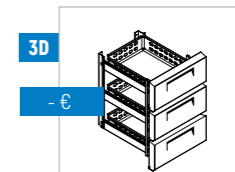

1/3 Çekmece - 1/3 Drawers

AIM

AIM DRY

DRY AGED BUZDOLAPLARI  
DRY AGED REFRIGERATORS

- Aktif karbon ve UVC sayesinde antibakteriyel soğutma  
Antibacterial cooling with an activated carbon filter and an active UVC light
- 304 Paslanmaz Çelik Raflar  
Stainless Steel Shelves
- Nem Kontrolü  
Humidity Control
- Rezistanslı Isıcam  
Heated Glass



## TEKNİK DETAYLAR / TECHNICAL DETAILS

TR

- Dış ortam sıcaklığı +43°C %65 nem oranı
- Eşit sıcaklık dağılımı için yeni tasarım
- Sıfır ODP enjekte 42 kg/m<sup>3</sup> çevre dostu poliüretan izolasyon
- Kolay okunur ekranlı dijital kontrol
- Ergonomik kapı ve kulpu sayesinde kolay açılma ve temizlik
- Patentli 'Icecool' soğutma sistemi ile mükemmel verim ve enerji sarfiyatı
- Sıcak gaz defrost sistemi
- Atık ısı geri kazanımlı kondansasyon
- Tüm buzdolapların marine versiyonları mevcuttur.
- Marine versiyonları 'Icecool marine' sistemi, marine ayak ve raflar içerir.

EN

- Designed to operate in 43°C ambient %65 humidity
- New design for equal temperature distribution
- Zero ODP Injected 42 kg/m<sup>3</sup> Polyurethane Insulation
- Digital controller with easy read screen
- Ergonomic door and handle designed for ease of opening and cleaning Icecool refrigeration system designed to be most technologically advanced and energy efficient yet
- Hot gas defrost system
- Waste heat recovery condensate vaporiser system
- All refrigerators can be produced in marine version
- Marine version includes 'Icecool marine' system, legs and shelves

AIM DRY

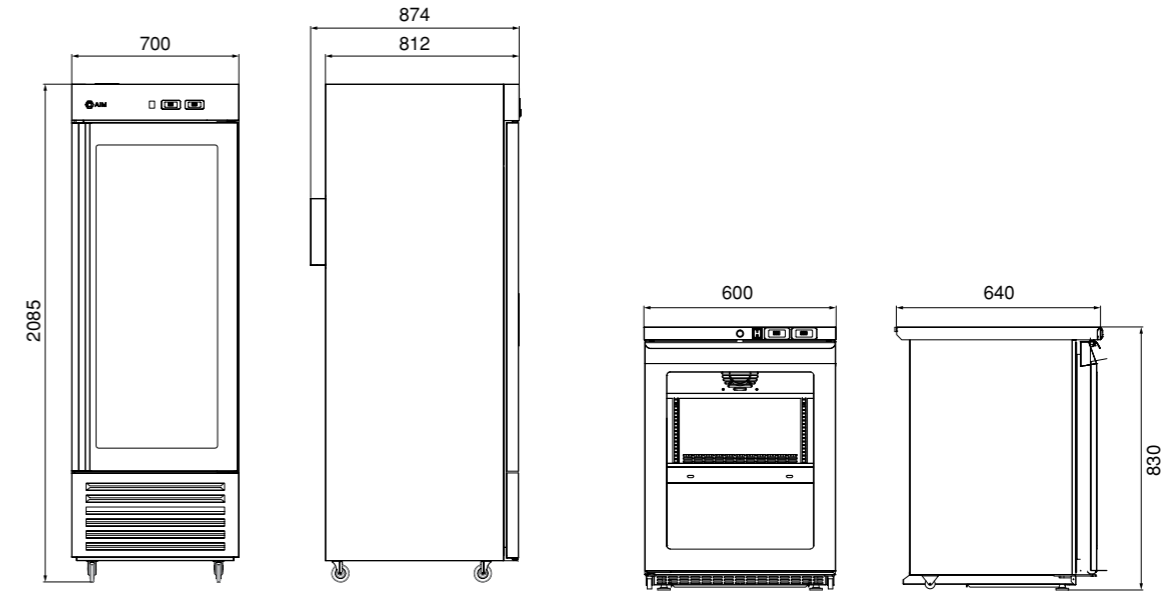

| KOD / CODE | °C      | (MM)          | lit  | 230V - 50Hz | kg  | (KW) | R134A | PASLANMAZ TİPİ<br>S.S. TYPE | € |
|------------|---------|---------------|------|-------------|-----|------|-------|-----------------------------|---|
| AIM 60DRY  | -3 / +5 | 600x640x820   | 140  | 230V - 50Hz | 70  | 0,32 | R134A | R304                        | - |
| AIM 70DRY  | -3 / +5 | 700x800x2100  | 610  | 230V - 50Hz | 129 | 0,76 | R134A | R304                        | - |
| AIM 14DRY  | -3 / +5 | 1400x800x2100 | 1340 | 230V - 50Hz | 197 | 1,20 | R134A | R304                        | - |

R290 R290 İstenildiği takdirde fiyatlara %3 ilave edilir. / For R290 Refrigerant gas, price increase is 3%.

## OPSİYONLAR / OPTIONS

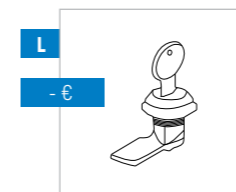

Dolap Kilidi / Cabinet Lock

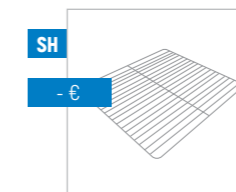
Raf ve Raf Kızağı /  
Shelf and Shelf Holder

AIM

AIM BLC

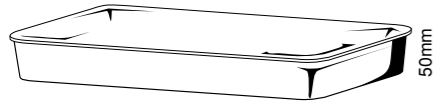
ŞOK DONDURUCULAR  
BLAST FREEZER/CHILLER

| KOD / CODE | 🌡️       | ❄️        | 📏<br>(MM)    | GN<br>1/1-60x40 | 🔌           | 👤<br>kg | ⚡<br>(KW) | 90dk<br>Soğutma Kapasitesi<br>Chiling Capacity | 240dk<br>Dondurma Kapasitesi<br>Freezing Capacity | PASLANMAZ TİPİ<br>S.S. TYPE | € |
|------------|----------|-----------|--------------|-----------------|-------------|---------|-----------|--|---|-----------------------------|---|
| AIM BLC5-0 | +90 / +3 | +90 / -18 | 900x1010x850 | 5               | 230V - 50Hz | 151     | 1,32      | 20 kg  | 12 kg   | 304                         | - |
| AIM BLC5   | +90 / +3 | +90 / -18 | 789x906x1107 | 5               | 230V - 50Hz | 167     | 1,47      | 20 kg  | 12 kg   | 304                         | - |
| AIM BLC7   | +90 / +3 | +90 / -18 | 789x906x1232 | 7               | 230V - 50Hz | 176     | 1,65      | 25 kg  | 18 kg   | 304                         | - |
| AIM BLC10  | +90 / +3 | +90 / -18 | 789x906x1412 | 10              | 230V - 50Hz | 208     | 2,41      | 30 kg  | 25 kg   | 304                         | - |
| AIM BLC15  | +90 / +3 | +90 / -18 | 789x906x1787 | 15              | 230V - 50Hz | 276     | 3,94      | 30 kg  | 25 kg   | 304                         | - |

Dış ortam sıcaklığı +32° / +32° Ambient temperature.

R290 İstenildiği takdirde fiyatlara %3 ilave edilir. / For R290 Refrigerant gas, price increase is 3%.

## TEKNİK DETAYLAR / TECHNICAL DETAILS

TR

- Dış ortam sıcaklığı +43°C %65 nem oranı
- Eşit sıcaklık dağılımı için yeni tasarım
- Sıfır ODP enjekte 42 kg/m<sup>3</sup> çevre dostu poliüretan izolasyon
- Kolay okunur ekranlı dijital kontrol
- Ergonomik kapı ve kulpu sayesinde kolay açılma ve temizlik
- Patentli 'Icecool' soğutma sistemi ile mükemmel verim ve enerji sarfiyatı
- Sıcak gaz defrost sistemi
- Atık ısı geri kazanımlı kondansasyon
- Tüm buzdolapların marine versiyonları mevcuttur.
- Marine versiyonları 'Icecool marine' sistemi, marine ayak ve raflar içerir.

EN

- Designed to operate in 43°C ambient %65 humidity
- New design for equal temperature distribution
- Zero ODP Injected 42 kg/m<sup>3</sup> Polyurethane Insulation
- Digital controller with easy read screen
- Ergonomic door and handle designed for ease of opening and cleaning
- Icecool refrigeration system designed to be most technologically advanced and energy efficient yet
- Hot gas defrost system
- Waste heat recovery condensate vaporiser system
- All refrigerators can be produced in marine version
- Marine version includes 'Icecool marine' system, legs and shelves

AIM BLC

BLC5

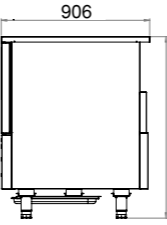
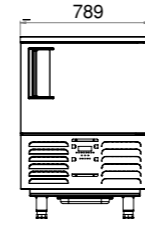

BLC7

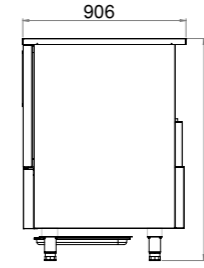
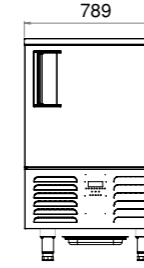

BLC10

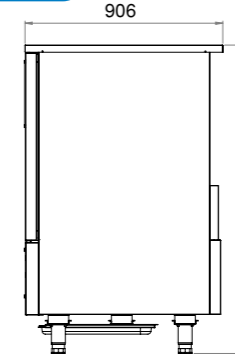
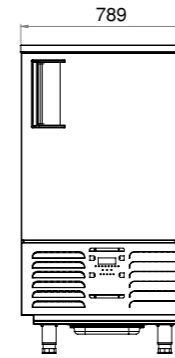

BLC15

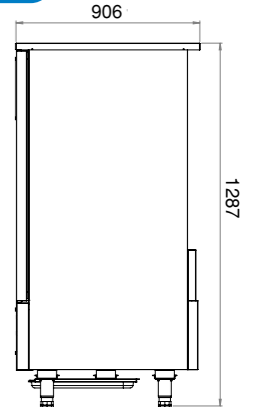
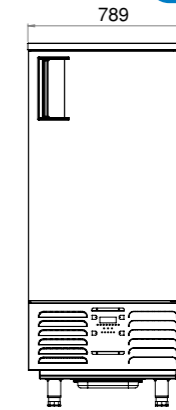

## OPSİYONLAR / OPTIONS

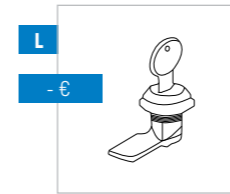
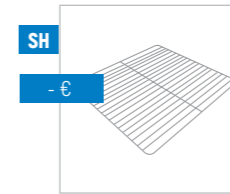
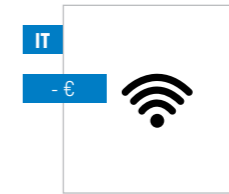
Dolap Kiliti /  
Cabinet LockRaf ve Raf Kızağı /  
Shelf and Shelf Holder

İnternet / Internet

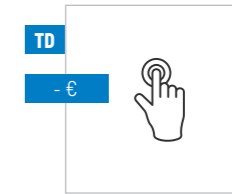
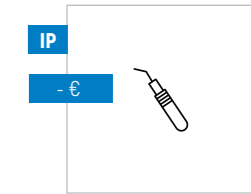
Dokunmatik Ekran /  
Touch Digitalİğne Portu / Needle  
Probe

# BAR SERİSİ SOĞUTUCULAR



## BAR SERIES COOLING LINE

### YENİ KONDENSER SİSTEMİ NEW CONDENSER SYSTEM



CLASSIC



AIMCLEAR

Temizlik gerektirmeyen kondenser  
Stayclear Condenser

### ENERJİ TASARRUFU SAVING ENERGY



Düşük enerji tüketimi sağlayan çevre dostu HFC içermeyen poliüretan izolasyon  
Eco friendly, HFC - free polyurethane insulation providing low energy consumption

### SICAK GAZ DEFOST İLE KARLANMAYAN EVAPARATÖR EVAPARATOR DOES NOT SNOW THROUGH HOT GAS DEFROST



CLASSIC

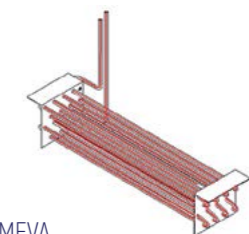

AIMEVA



# AIM 140

TEZGAH ALTI MİNİ BUZDOLAPLARI  
UNDERCOUNTER REFRIGERATORS



## TEKNİK DETAYLAR / TECHNICAL DETAILS

### TR

- Dış ortam sıcaklığı +43°C %65 nem oranı
- Eşit sıcaklık dağılımı için yeni tasarım
- Sıfır ODP enjekte 42 kg/m<sup>3</sup> çevre dostu poliüretan izolasyon
- Kolay okunur ekranlı dijital kontrol
- Ergonomik kapı ve kulpu sayesinde kolay açılma ve temizlik
- Patentli 'Icecool' soğutma sistemi ile mükemmel verim ve enerji sarfiyatı
- Sıcak gaz defrost sistemi
- Atık ısı geri kazanımlı kondanzasyon

### EN

- Designed to operate in 43°C ambient %65 humidity
- New design for equal temperature distribution
- Zero ODP Injected 42 kg/m<sup>3</sup> Polyurethane Insulation
- Digital controller with easy read screen
- Ergonomic door and handle designed for ease of opening and cleaning Icecool refrigeration system designed to be most
- tecnologically advanced and energy efficient yet
- Hot gas defrost system
- Waste heat recovery condensate vaporiser system

## AIM 140

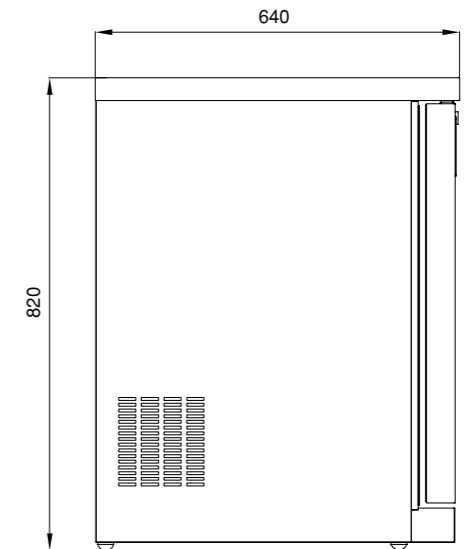
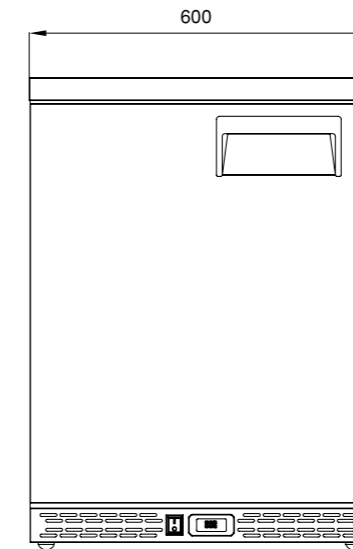

| KOD / CODE | 🌡️        | 📏 (MM)      | It  | 🔌           | kg | (KW) | ❄️    | PASLANMAZ TİPİ<br>S.S. TYPE | € |
|------------|-----------|-------------|-----|-------------|----|------|-------|-----------------------------|---|
| AIM 140R3  | -2 / +8   | 600x640x820 | 140 | 230V - 50Hz | 62 | 0,25 | R134A | 304                         | - |
| AIM 140R4  | -2 / +8   | 600x640x820 | 140 | 230V - 50Hz | 62 | 0,25 | R134A | 430                         | - |
| AIM 140F3  | -10 / -22 | 600x640x820 | 140 | 230V - 50Hz | 62 | 0,25 | R404A | 304                         | - |
| AIM 140F4  | -10 / -22 | 600x640x820 | 140 | 230V - 50Hz | 62 | 0,25 | R404A | 430                         | - |
| AIM G140R3 | -2 / +8   | 600x640x820 | 140 | 230V - 50Hz | 62 | 0,25 | R134A | 304                         | - |
| AIM G140R4 | -2 / +8   | 600x640x820 | 140 | 230V - 50Hz | 62 | 0,25 | R134A | 430                         | - |
| AIM G140F3 | -10 / -22 | 600x640x820 | 140 | 230V - 50Hz | 62 | 0,25 | R404A | 304                         | - |
| AIM G140F4 | -10 / -22 | 600x640x820 | 140 | 230V - 50Hz | 62 | 0,25 | R404A | 430                         | - |

R290 R290 istenildiği takdirde fiyatlara %3 ilave edilir. / For R290 Refrigerant gas, price increase is 3%.

## OPSİYONLAR / OPTIONS

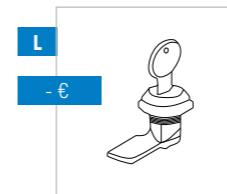

Dolap Kilidi / Cabinet Lock

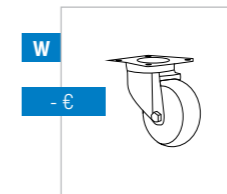

Tekerlekli - Wheels



# AIM BB2 / BB3

BAR TİPİ BUZDOLAPLARI - ÇARPMA KAPI  
BAR TYPE CHILLERS - HINGED DOORS

BB2



BB3



PB2



PB3



## TEKNİK DETAYLAR / TECHNICAL DETAILS

### TR

- PVC kaplı galvaniz sac.
- CFC Free soğutma gazı: R 134A / R 404A
- Dış ortam sıcaklığı: +32 °C
- Fanlı soğutma.
- Dijital termometre ve termostat.
- Otomatik defrost.
- Kapılarda kilit.
- Özel kapı menteşe sistemi.
- Temizlenebilir ve sökülebilir manyetik kapı contası. - Çarpma Kapaklı.
- Çalışma Sıcaklığı: 2/10 °C

### EN

- PVC coated galvanized steel.
- "CFC Free" refrigerant gas: R 134A / R 404 A
- +32 °C ambient temp.
- Fan cooling.
- Digital thermometer and thermostat.
- Automatic defrosting.
- Lock system in the door.
- Special door hinge system.
- Removable and easy to clean magnetic door. - Hinged Doors.
- Working temperature: 2/10 °C

| KOD / CODE | 🌡️       | 📏<br>(MM)    | 📏<br>It | 🔌           | 📊<br>kg | ⚡<br>(KW) | ❄️    | € |
|------------|----------|--------------|---------|-------------|---------|-----------|-------|---|
| AIM BB2    | +2 / +10 | 900x525x900  | 210     | 230V - 50Hz | 90      | 0,21      | R134A | - |
| AIM BB3    | +2 / +10 | 1350x525x900 | 310     | 230V - 50Hz | 120     | 0,25      | R134A | - |

R290 istenildiği takdirde fiyatlara %3 ilave edilir. / For R290 Refrigerant gas, price increase is 3%.

# AIM PB2 / PB3

PASLANMAZ BAR TİPİ BUZDOLAPLARI - ÇARPMA KAPI  
STAINLESS BAR TYPE CHILLERS - HINGED DOORS

## TEKNİK DETAYLAR / TECHNICAL DETAILS

### TR

- Dış ortam sıcaklığı 42 °C - %65 nem
- Sökülüp temizlenebilir manyetik kapı contası
- Akıllı elektrikli otomatik defrost
- LED aydınlatma
- Fanlı soğutma
- Yükseklik ayarlanabilir paslanmaz ayaklar
- 30 mm izolasyon kalınlığı
- 60 mm kapı izolasyon kalınlığı
- Kilitli kapılar

### EN

- Tested at ambient temp.42°C -%65 humidity
- Removable and easy cleaning magnetic gaskets
- Smart electrical auto-defrost
- LED lighting
- Fan cooling
- Stainless steel legs for height adjustment
- Lockable door
- 30 mm body insulation
- 60 mm door insulation

| KOD / CODE | 🌡️       | 📏<br>(MM)    | 📏<br>It | 🔌           | 📊<br>kg | ⚡<br>(KW) | ❄️    | € |
|------------|----------|--------------|---------|-------------|---------|-----------|-------|---|
| AIM PB2    | +2 / +10 | 900x525x900  | 210     | 230V - 50Hz | 90      | 0,21      | R134A | - |
| AIM PB3    | +2 / +10 | 1350x525x900 | 310     | 230V - 50Hz | 120     | 0,25      | R134A | - |

R290 istenildiği takdirde fiyatlara %3 ilave edilir. / For R290 Refrigerant gas, price increase is 3%.



# AIM CPC

KOKTEYL HAZIRLIK BUZDOLAPLARI  
COCKTAIL PREPARATION COUNTER

DAHİLİ BARDAK  
DURULAMA SİSTEMİ

INTEGRATED GLASS  
RINSER

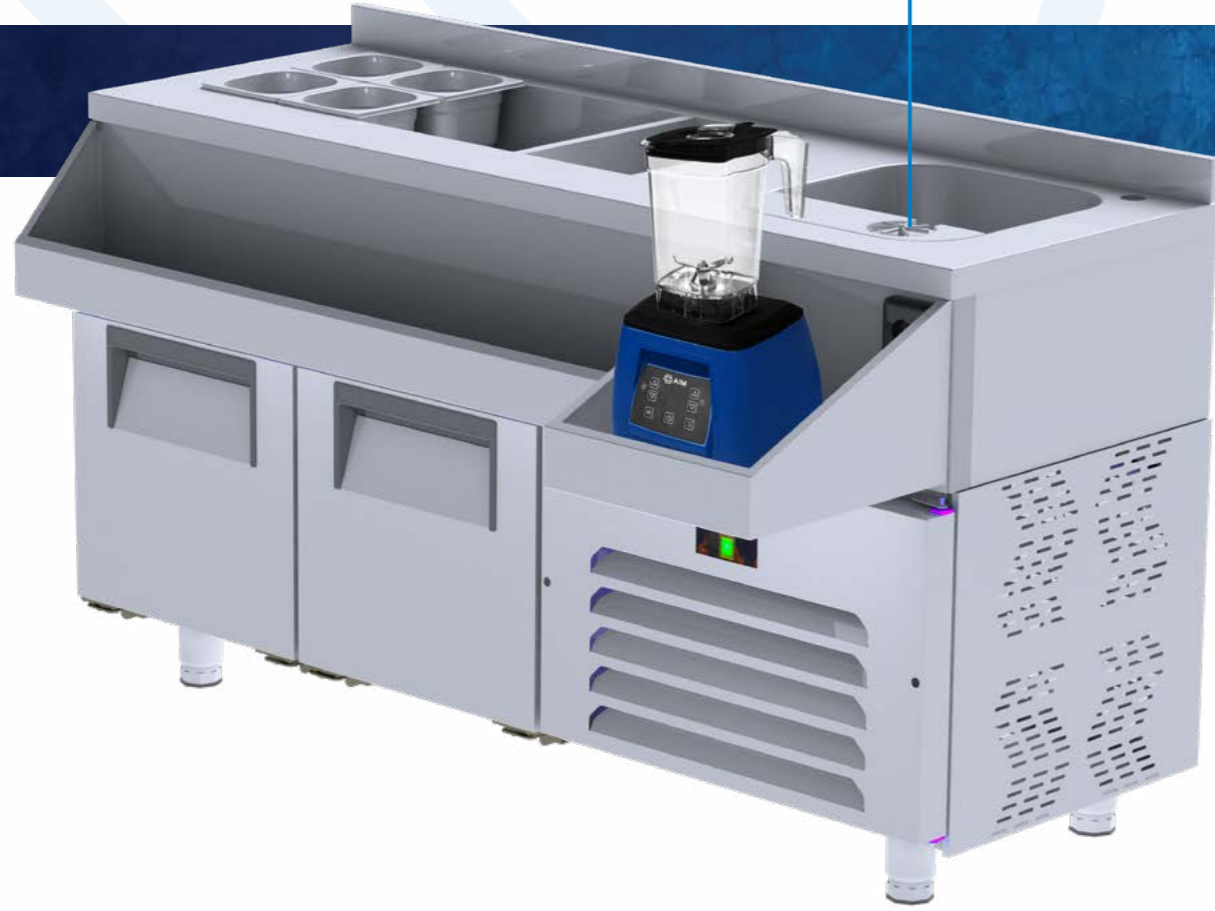

## TEKNİK DETAYLAR / TECHNICAL DETAILS

TR

- Tropikal iklim sınıfı +43 °C
- Temizlik gerektirmeyen kondenser
- Sıfır ODP enjekte 42 kg/ m<sup>3</sup> çevre dostu poliüretan izolasyon
- Antibakteriyel buz saklama alanı
- Manyetik pompa ile sessiz çalışma
- Elektronik kontrol
- İzalasyonlu buz haznesi
- Ergonomik kapak kulbu
- Patentli nozul sistemi ile daha kısa süreli buz döngüsü
- 1/1 Çekmece kapasitesi

EN

- Tropical class +43 °C
- Stay clear condenser
- Zero ODP injected 42 kg/ m<sup>3</sup> polyurathane insulation
- Antibacterial storage area
- Silent operation with magnetic pump
- Electronic control
- Insulated ice chest
- Ergonomic door handle
- Patented nozzle system provides less cycles
- 1/1 Drawer capacity

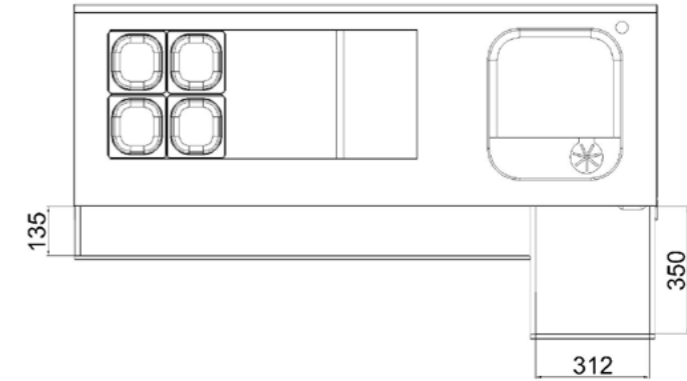
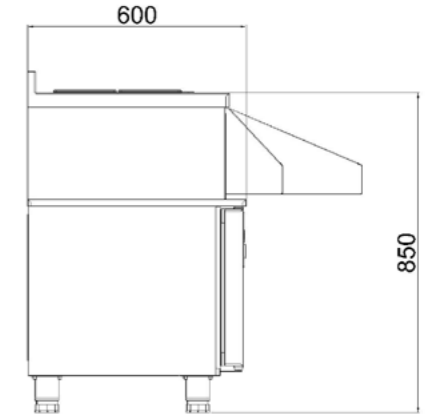
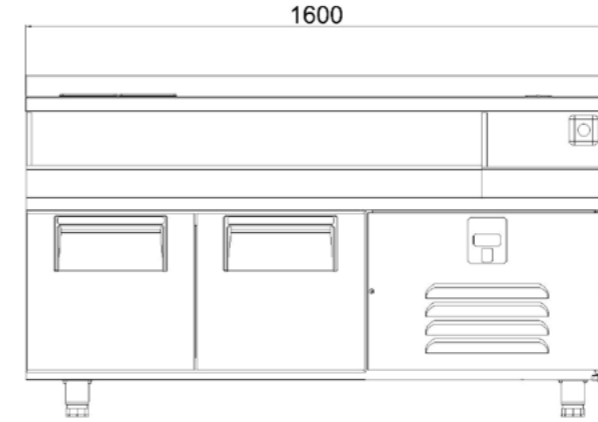

| KOD / CODE | °C      | (MM)         | it  | ⏻           | kg  | (KW) | ❄️    | PASLANMAZ TİPİ<br>S.S. TYPE | € |
|------------|---------|--------------|-----|-------------|-----|------|-------|-----------------------------|---|
| AIM CPC2-3 | -2 / +8 | 1200x600x850 | 190 | 230V - 50Hz | 110 | 0,17 | R134A | 304                         | - |
| AIM CPC2-4 | -2 / +8 | 1200x600x850 | 190 | 230V - 50Hz | 110 | 0,17 | R134A | 430                         | - |
| AIM CPC3-3 | -2 / +8 | 1600x600x850 | 280 | 230V - 50Hz | 146 | 0,34 | R134A | 304                         | - |
| AIM CPC3-4 | -2 / +8 | 1600x600x850 | 280 | 230V - 50Hz | 146 | 0,34 | R134A | 430                         | - |

R290 R290 İstenildiği takdirde fiyatlara %3 ilave edilir. / For R290 Refrigerant gas, price increase is 3%.

UNLU  
MAMÜL  
SOĞUTUCULAR



BAKERY  
COOLING  
LINE



AIM

## AIM PR60

DİK TİP PATİSERİ BUZDOLABI - 1 KAPILI  
VERTICAL PÂTISSERIE REFRIGERATORS - W/1 DOOR40x60 TEPSİ KAPASİTESİ  
40x60 TRAY CAPACITY

## TEKNİK DETAYLAR / TECHNICAL DETAILS

TR

- Dış ortam sıcaklığı +43°C %65 nem oranı
- Eşit sıcaklık dağılımı için yeni tasarım
- Sıfır ODP enjekte 42 kg/m<sup>3</sup> çevre dostu poliüretan izolasyon
- Kolay okunur ekranlı dijital kontrol
- Ergonomik kapı ve kulpu sayesinde kolay açılma ve temizlik
- Patentli 'Icecool' soğutma sistemi ile mükemmel verim ve enerji sarfiyatı
- Sıcak gaz defrost sistemi
- Atık ısı geri kazanımlı kondansasyon
- 22 adet 40x60 tepsi kapasitesi

EN

- Designed to operate in 43°C ambient %65 humidity
- New design for equal temperature distribution
- Zero ODP Injected 42 kg/m<sup>3</sup> Polyurethane Insulation
- Digital controller with easy read screen
- Ergonomic door and handle designed for ease of opening and cleaning
- Icecool refrigeration system designed to be most technologically advanced and energy efficient yet
- Hot gas defrost system
- Waste heat recovery condensate vaporiser system
- 22 no's of 40x60 tray capacity

## AIM PR60

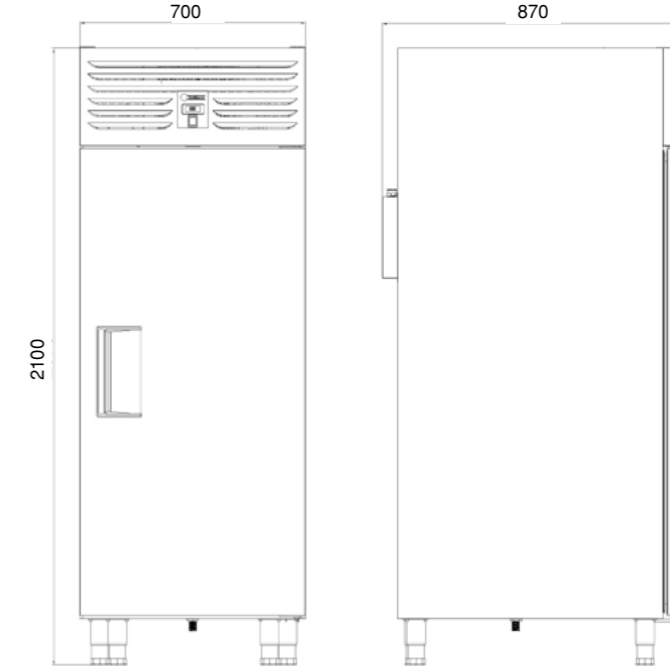

| KOD / CODE | °C        | [MM]         | lt  | 230V - 50Hz | kg  | (KW) | R     | KAPASİTE<br>CAPACITY<br>40X60 | PASLANMAZ TİPİ<br>S.S. TYPE | € |
|------------|-----------|--------------|-----|-------------|-----|------|-------|-------------------------------|-----------------------------|---|
| AIM PR60R3 | -2 / +8   | 700x870x2100 | 610 | 230V - 50Hz | 124 | 0,32 | R134A | 22                            | 304                         | - |
| AIM PR60R4 | -2 / +8   | 700x870x2100 | 610 | 230V - 50Hz | 124 | 0,32 | R134A | 22                            | 430                         | - |
| AIM PR60F3 | -10 / -22 | 700x870x2100 | 610 | 230V - 50Hz | 124 | 0,70 | R404A | 22                            | 304                         | - |
| AIM PR60F4 | -10 / -22 | 700x870x2100 | 610 | 230V - 50Hz | 124 | 0,70 | R404A | 22                            | 430                         | - |

R290 İstenildiği takdirde fiyatlara %3 ilave edilir. / For R290 Refrigerant gas, price increase is 3%.

## OPSİYONLAR / OPTIONS

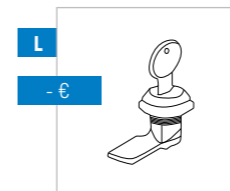

Dolap Kilidi / Cabinet Lock

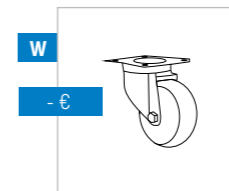

Tekerlekli - Wheels

AIM

## AIM PR70

DİK TİP PATİSERİ BUZDOLABI - 1 KAPILI  
VERTICAL PATISSERIE REFRIGERATORS - W/1 DOOR60x80 TEPSİ KAPASİTESİ  
60x80 TRAY CAPACITY

## TEKNİK DETAYLAR / TECHNICAL DETAILS

TR

- Dış ortam sıcaklığı +43°C %65 nem oranı
- Eşit sıcaklık dağılımı için yeni tasarım
- Sıfır ODP enjekte 42 kg/m<sup>3</sup> çevre dostu poliüretan izolasyon
- Kolay okunur ekranlı dijital kontrol
- Ergonomik kapı ve kulpu sayesinde kolay açılma ve temizlik
- Patentli 'Icecool' soğutma sistemi ile mükemmel verim ve enerji sarfiyatı
- Sıcak gaz defrost sistemi
- Atık ısı geri kazanımlı kondansasyon
- 22 adet 60x80 tepsi kapasitesi

EN

- Designed to operate in 43°C ambient %65 humidity
- New design for equal temperature distribution
- Zero ODP Injected 42 kg/m<sup>3</sup> Polyurethane Insulation
- Digital controller with easy read screen
- Ergonomic door and handle designed for ease of opening and cleaning
- Icecool refrigeration system designed to be most technologically advanced and energy efficient yet
- Hot gas defrost system
- Waste heat recovery condensate vaporiser system
- 22 no's of 60x80 tray capacity

## AIM PR70

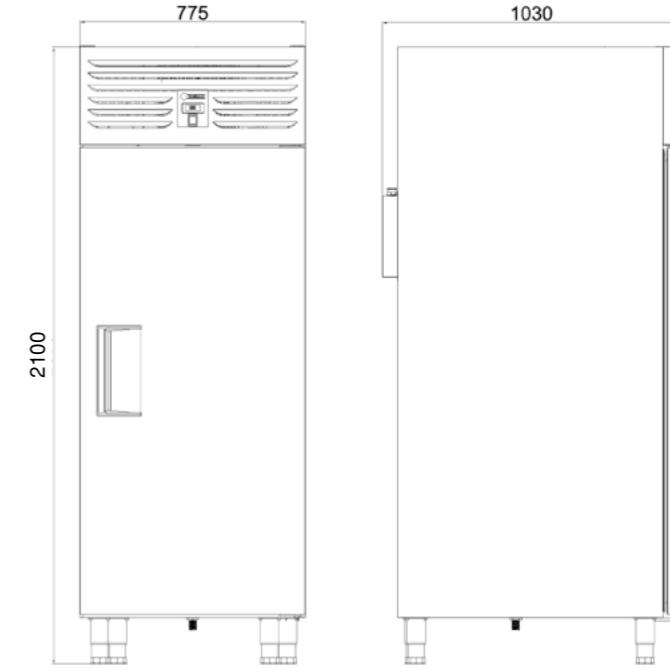

| KOD / CODE | °C        | (MM)          | lt  | 230V - 50Hz | kg  | (KW) | R134A | KAPASİTE<br>CAPACITY<br>60X80 | PASLANMAZ TİPİ<br>S.S. TYPE | € |
|------------|-----------|---------------|-----|-------------|-----|------|-------|-------------------------------|-----------------------------|---|
| AIM PR70R3 | -2 / +8   | 775x1030x2100 | 730 | 230V - 50Hz | 160 | 0,32 | R134A | 22                            | 304                         | - |
| AIM PR70R4 | -2 / +8   | 775x1030x2100 | 730 | 230V - 50Hz | 160 | 0,32 | R134A | 22                            | 430                         | - |
| AIM PR70F3 | -10 / -22 | 775x1030x2100 | 730 | 230V - 50Hz | 160 | 0,70 | R404A | 22                            | 304                         | - |
| AIM PR70F4 | -10 / -22 | 775x1030x2100 | 730 | 230V - 50Hz | 160 | 0,70 | R404A | 22                            | 430                         | - |

R290 R290 İstenildiği takdirde fiyatlara %3 ilave edilir. / For R290 Refrigerant gas, price increase is 3%.

## OPSİYONLAR / OPTIONS

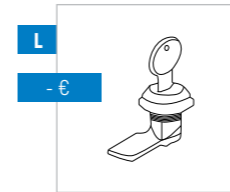

Dolap Kilidi / Cabinet Lock

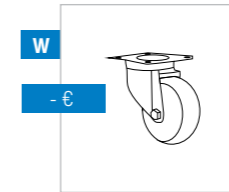

Tekertekli - Wheels

AIM

## AIM PR14

DİK TİP PATİSERİ BUZDOLABI - 2 KAPILI  
VERTICAL PATISSERIE REFRIGERATORS - W/2 DOORS60x80 TEPŞİ KAPASİTESİ  
60x80 TRAY CAPACITY

## TEKNİK DETAYLAR / TECHNICAL DETAILS

TR

- Dış ortam sıcaklığı +43°C %65 nem oranı
- Eşit sıcaklık dağılımı için yeni tasarım
- Sıfır ODP enjekte 42 kg/m<sup>3</sup> çevre dostu poliüretan izolasyon
- Kolay okunur ekranlı dijital kontrol
- Ergonomik kapı ve kulpu sayesinde kolay açılma ve temizlik
- Patentli 'Icecool' soğutma sistemi ile mükemmel verim ve enerji sarfiyatı
- Sıcak gaz defrost sistemi
- Atık ısı geri kazanımlı kondansasyon
- 44 adet 60x80 tepsi kapasitesi

EN

- Designed to operate in 43°C ambient %65 humidity
- New design for equal temperature distribution
- Zero ODP Injected 42 kg/m<sup>3</sup> Polyurethane Insulation
- Digital controller with easy read screen
- Ergonomic door and handle designed for ease of opening and cleaning
- Icecool refrigeration system designed to be most technologically advanced and energy efficient yet
- Hot gas defrost system
- Waste heat recovery condensate vaporiser system
- 44 no's of 60x80 tray capacity

## AIM PR14

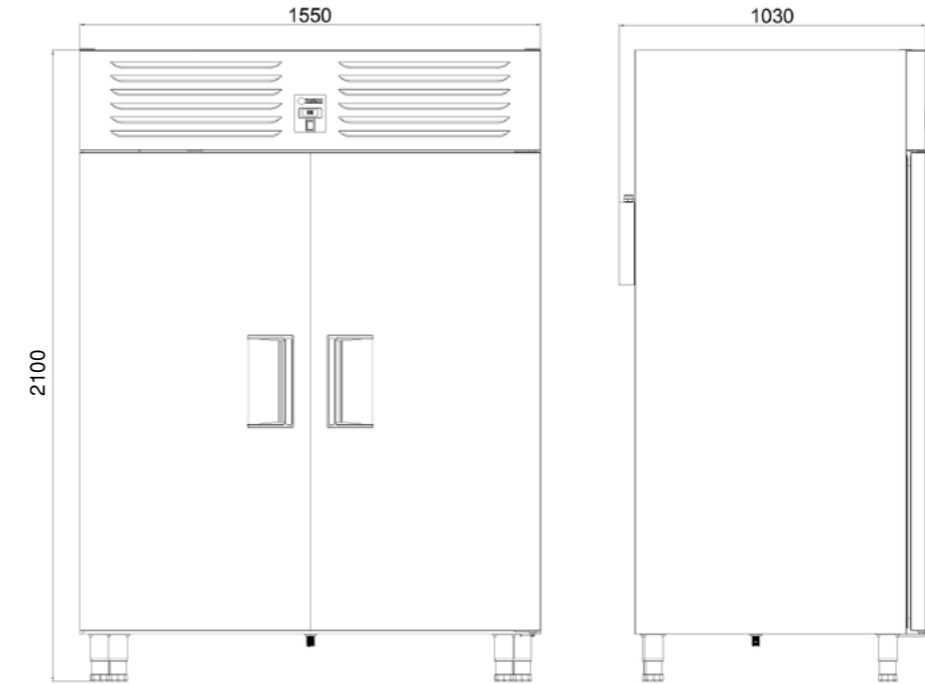

| KOD / CODE | °C        | mm             | lt   | 230V - 50Hz | kg  | (kW) | R     | KAPASİTE<br>CAPACITY<br>60X80 | PASLANMAZ TİPİ<br>S.S. TYPE | € |
|------------|-----------|----------------|------|-------------|-----|------|-------|-------------------------------|-----------------------------|---|
| AIM PR14R3 | -2 / +8   | 1550x1030x2100 | 1460 | 230V - 50Hz | 300 | 0,35 | R134A | 44                            | 304                         | - |
| AIM PR14R4 | -2 / +8   | 1550x1030x2100 | 1460 | 230V - 50Hz | 300 | 0,35 | R134A | 44                            | 430                         | - |
| AIM PR14F3 | -10 / -22 | 1550x1030x2100 | 1460 | 230V - 50Hz | 300 | 0,80 | R404A | 44                            | 304                         | - |
| AIM PR14F4 | -10 / -22 | 1550x1030x2100 | 1460 | 230V - 50Hz | 300 | 0,80 | R404A | 44                            | 430                         | - |

R290 İstenildiği takdirde fiyatlara %3 ilave edilir. / For R290 Refrigerant gas, price increase is 3%.

## OPSİYONLAR / OPTIONS

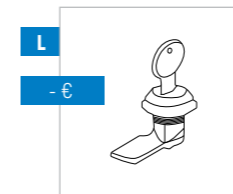

Dolap Kilidi / Cabinet Lock

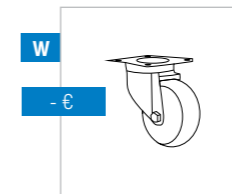

Tekerekli - Wheels

AIM

## AIM 208

TEZGAH TİP PATİSERİ BUZDOLABI - 3 KAPILI  
COUNTER PATISSERIE REFRIGERATORS - W/3 DOOR

## TEKNİK DETAYLAR / TECHNICAL DETAILS

TR

- Dış ortam sıcaklığı +43°C %65 nem oranı
- Eşit sıcaklık dağılımı için yeni tasarım
- Sıfır ODP enjekte 42 kg/m<sup>3</sup> çevre dostu poliüretan izolasyon
- Kolay okunur ekranlı dijital kontrol
- Ergonomik kapı ve kulpu sayesinde kolay açılma ve temizlik
- Patentli 'Icecool' soğutma sistemi ile mükemmel verim ve enerji sarfiyatı
- Sıcak gaz defrost sistemi
- Atık ısı geri kazanımlı kondanzasyon
- 22 adet 40x60 tepsi kapasitesi

EN

- Designed to operate in 43°C ambient %65 humidity
- New design for equal temperature distribution
- Zero ODP Injected 42 kg/m<sup>3</sup> Polyurethane Insulation
- Digital controller with easy read screen
- Ergonomic door and handle designed for ease of opening and cleaning
- Icecool refrigeration system designed to be most technologically advanced and energy efficient yet
- Hot gas defrost system
- Waste heat recovery condensate vaporiser system
- 22 no's of 40x60 tray capacity

AIM 208

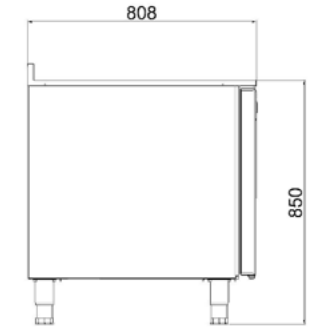
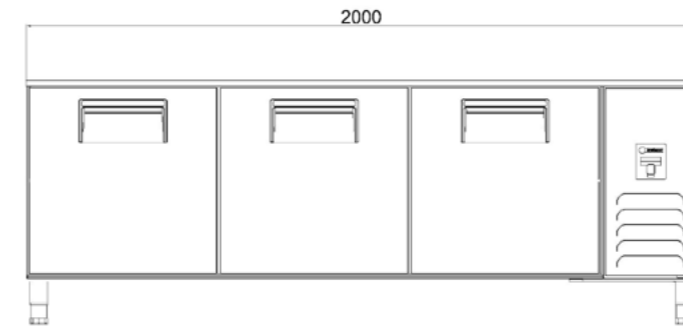

| KOD / CODE | °C        | (MM)         | It  | Power       | kg  | (kW) | Refrigerant | KAPASİTE<br>CAPACITY<br>40X60 | PASLANMAZ TİPİ<br>S.S. TYPE | €     |
|------------|-----------|--------------|-----|-------------|-----|------|-------------|-------------------------------|-----------------------------|-------|
| AIM 208R3  | -2 / +8   | 2000x810x850 | 600 | 230V - 50Hz | 137 | 0,34 | R134A       | 22                            | 304                         | 3.469 |
| AIM 208R4  | -2 / +8   | 2000x810x850 | 600 | 230V - 50Hz | 137 | 0,34 | R134A       | 22                            | 430                         | 2.959 |
| AIM 208F3  | -10 / -22 | 2000x810x850 | 600 | 230V - 50Hz | 137 | 0,75 | R404A       | 22                            | 304                         | 4.082 |
| AIM 208F4  | -10 / -22 | 2000x810x850 | 600 | 230V - 50Hz | 137 | 0,75 | R404A       | 22                            | 430                         | 3.652 |

R290 İstenildiği takdirde fiyatlara %3 ilave edilir. / For R290 Refrigerant gas, price increase is 3%.

## OPSİYONLAR / OPTIONS

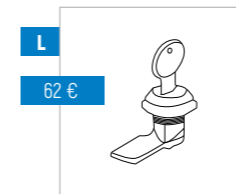

Dolap Kilidi / Cabinet Lock

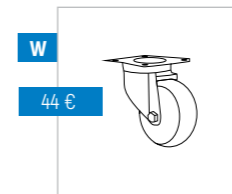

Tekerekli - Wheels



# AIM CSF80 / CSF16

-30° PASTA ŞOKLAMA DOLABI  
-30° CAKE BLAST FREEZER



## TEKNİK DETAYLAR / TECHNICAL DETAILS

TR

- Dış ortam sıcaklığı +43°C %65 nem oranı
- Eşit sıcaklık dağılımı için yeni tasarım
- Sıfır ODP enjekte 42 kg/m<sup>3</sup> çevre dostu poliüretan izolasyon
- Kolay okunur ekranlı dijital kontrol
- Ergonomik kapı ve kulpu sayesinde kolay açılma ve temizlik
- Patentli 'Icecool' soğutma sistemi ile mükemmel verim ve enerji sarfiyatı
- Sıcak gaz defrost sistemi
- Atık ısı geri kazanımlı kondansasyon
- 22 adet 60x80 tepsi kapasitesi

EN

- Designed to operate in 43°C ambient %65 humidity
- New design for equal temperature distribution
- Zero ODP Injected 42 kg/m<sup>3</sup> Polyurethane Insulation
- Digital controller with easy read screen
- Ergonomic door and handle designed for ease of opening and cleaning
- Icecool refrigeration system designed to be most technologically advanced and energy efficient yet
- Hot gas defrost system
- Waste heat recovery condensate vaporiser system
- 22 no's of 60x80 tray capacity

## AIM CSF80 / CSF16

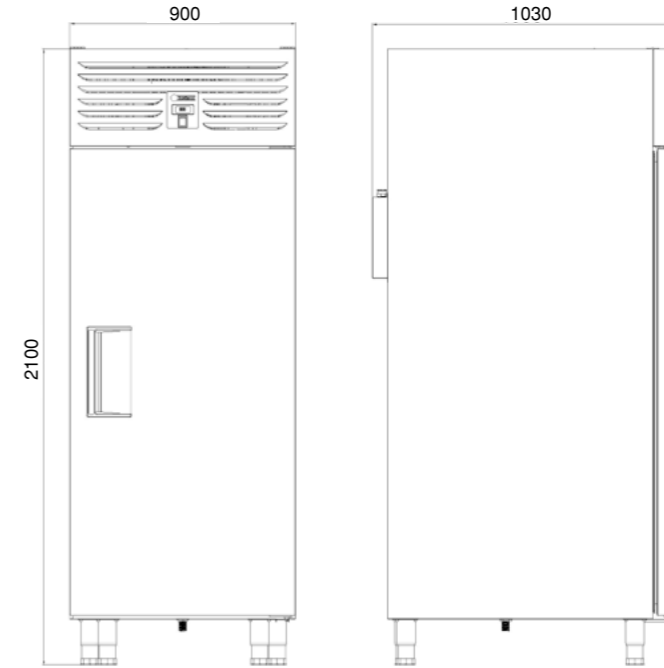

| KOD / CODE  | °C        | (MM)           | It   | 230V - 50Hz | kg  | (KW) | R404A | KAPASİTE<br>CAPACITY<br>60X80 | PASLANMAZ TİPİ<br>S.S. TYPE | € |
|-------------|-----------|----------------|------|-------------|-----|------|-------|-------------------------------|-----------------------------|---|
| AIM CSFS803 | -10 / -30 | 900x1030x2100  | 800  | 230V - 50Hz | 160 | 0,8  | R404A | 22                            | 304                         | - |
| AIM CSFS804 | -10 / -30 | 900x1030x2100  | 800  | 230V - 50Hz | 160 | 0,8  | R404A | 22                            | 430                         | - |
| AIM CSF163  | -10 / -30 | 1800x1030x2100 | 1600 | 230V - 50Hz | 190 | 1,1  | R404A | 44                            | 304                         | - |
| AIM CSF164  | -10 / -30 | 1800x1030x2100 | 1600 | 230V - 50Hz | 190 | 1,1  | R404A | 44                            | 430                         | - |

R290 İstenildiği takdirde fiyatlara %3 ilave edilir. / For R290 Refrigerant gas, price increase is 3%.

## OPSİYONLAR / OPTIONS

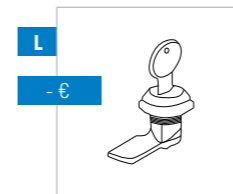

Dolap Kilidi / Cabinet Lock

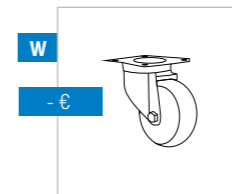

Tekerlekli - Wheels



# AIM RP600

MAYALANDIRMA BUZDOLABI  
RETARDER PROVER



## TEKNİK DETAYLAR / TECHNICAL DETAILS

### TR

- Dış ortam sıcaklığı +43°C %65 nem oranı
- Eşit sıcaklık dağılımı için yeni tasarım
- Sıfır ODP enjekte 42 kg/m<sup>3</sup> çevre dostu poliüretan izolasyon
- Kolay okunur ekranlı dijital kontrol
- Ergonomik kapı ve kulpu sayesinde kolay açılma ve temizlik
- Patentli 'Icecool' soğutma sistemi ile mükemmel verim ve enerji sarfiyatı
- Sıcak gaz defrost sistemi
- Atık ısı geri kazanımlı kondansasyon
- İç ısı dağılım dengesini sağlayan hava yönlendirme sistemi
- İleri tarihli, gerçek zaman ayarlı otomatik fermantasyon sistemi
- 20 adet 40x60 tepsi kapasitesi

### EN

- Designed to operate in 43°C ambient %65 humidity
- New design for equal temperature distribution
- Zero ODP Injected 42 kg/m<sup>3</sup> Polyurethane Insulation
- Digital controller with easy read screen
- Ergonomic door and handle designed for ease of opening and cleaning
- Icecool refrigeration system designed to be most technologically advanced and energy efficient yet
- Hot gas defrost system
- Waste heat recovery condensate vaporiser system
- Air managing system which provides inside refrigeration balance
- Forthcoming real-time automated fermentation system.
- 20 no's of 40x60 tray capacity

## AIM RP600

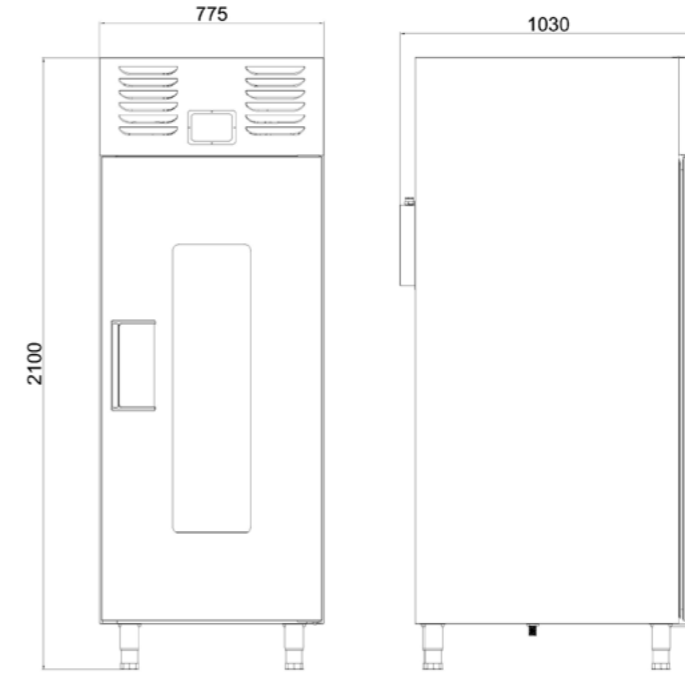

## OPSİYONLAR / OPTIONS

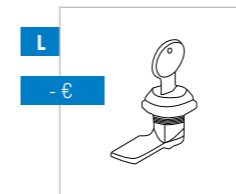

Dolap Kilidi / Cabinet Lock

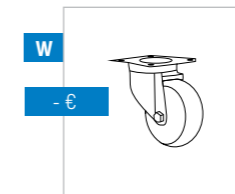

Tekerlekli - Wheels

| KOD / CODE | °C        | (MM)          | lt  | Power       | kg  | (KW) | R134A | KAPASİTE<br>CAPACITY<br>40X60 | PASLANMAZ TİPİ<br>S.S. TYPE | € |
|------------|-----------|---------------|-----|-------------|-----|------|-------|-------------------------------|-----------------------------|---|
| AIM RP600  | -18 / +45 | 775x1030x2100 | 668 | 230V - 50Hz | 140 | 0,65 | R134A | 20                            | 304                         | - |

BUZ  
MAKİNELERİ



ICE CUBE  
MACHINE



AIM

## AIM 20-30-50

BUZ MAKİNASI  
ICE CUBE MACHINE

## TEKNİK DETAYLAR / TECHNICAL DETAILS

TR

- Tropikal iklim sınıfı +43 °C
- Temizlik gerektirmeyen kondenser
- Sıfır ODP enjekte 42 kg/ m<sup>3</sup> çevre dostu poliüretan izolasyon
- Antibakteriyel buz saklama alanı
- Manyetik pompa ile sessiz çalışma
- Elektronik kontrol
- Geniş buz depolama alanı
- Ergonomik kapak kulbu
- Patentli nozul sistemi ile daha kısa süreli buz döngüsü

EN

- Tropical class +43 °C
- Stay clear condenser
- Zero ODP injected 42 kg/ m<sup>3</sup> polyurathane insulation
- Antibacterial storage area
- Silent operation with magnetic pump
- Electronic control
- Large ice storage bin
- Ergonomic door handle
- Patented nozzle system provides less cycles



## AIM 20-30-50

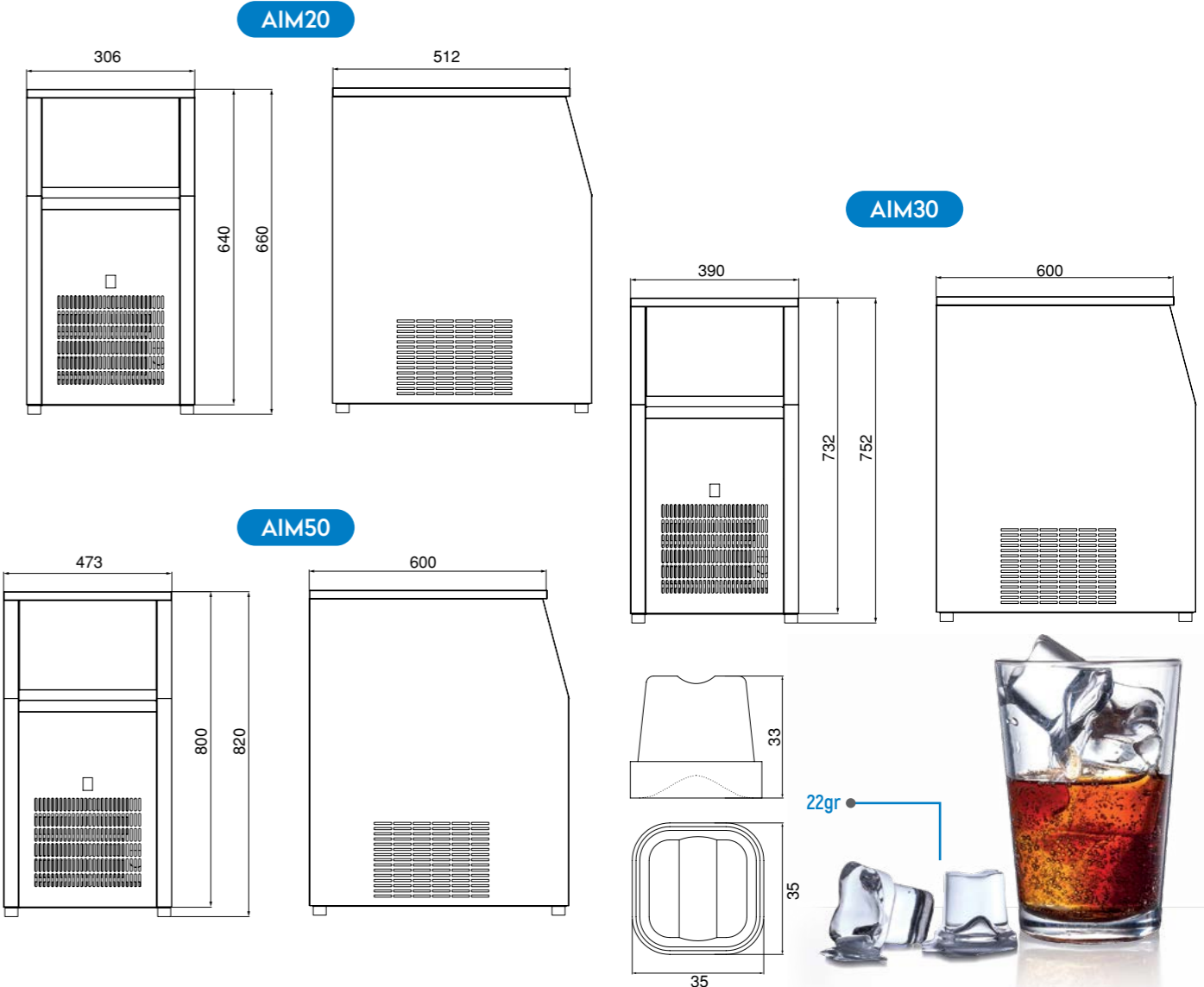

| KOD / CODE  | AIM 20            | AIM 30            | AIM 50            |
|---|-------------------|-------------------|-------------------|
| Günlük Buz Yapma Kapasitesi / Ice Making Capacity Per Day | 20 kg             | 30 kg             | 45 kg             |
| Soğutma Sistemi / Cooling System                          | Hava (Air Cooled) | Hava (Air Cooled) | Hava (Air Cooled) |
| Maksimum Güç / Maximum Power                              | 540 W             | 540 W             | 620 W             |
| İklim Sınıfı / Tropical Class                             | T                 | T                 | T                 |
| Ürün Ölçüleri / Product Dimensions (mm)                   | 306 x 512 x 660   | 390 x 600 x 730   | 473 x 600 x 820   |
| Ambalaj Ölçüleri / Packing Dimensions (mm)                | 360 x 565 x 970   | 440 x 650 x 1000  | 530 x 650 x 1100  |
| Ürün Ağırlığı / Product Weight                            | 40 kg             | 48 kg             | 56 kg             |
| Fiyat / Price   | - €               | - €               | - €               |

R290 R290 İstenildiği takdirde fiyatlara %3 ilave edilir. / For R290 Refrigerant gas, price increase is 3%.

AIM

## AIM 90-130

BUZ MAKİNASI  
ICE CUBE MACHINE

AIM90

90KG/GÜN  
90KG/DAY

AIM130

130KG/GÜN  
130KG/DAY

## TEKNİK DETAYLAR / TECHNICAL DETAILS

TR

- Tropikal iklim sınıfı +43 °C
- Temizlik gerektirmeyen kondenser
- Sıfır ODP enjekte 42 kg/ m<sup>3</sup> çevre dostu poliüretan izolasyon
- Antibakteriyel buz saklama alanı
- Manyetik pompa ile sessiz çalışma
- Elektronik kontrol
- Geniş buz depolama alanı
- Ergonomik kapak kulbu
- Patentli nozul sistemi ile daha kısa süreli buz döngüsü

EN

- Tropical class +43 °C
- Stay clear condenser
- Zero ODP injected 42 kg/ m<sup>3</sup> polyurathane insulation
- Antibacterial storage area
- Silent operation with magnetic pump
- Electronic control
- Large ice storage bin
- Ergonomic door handle
- Patented nozzle system provides less cycles

## AIM 90-130

AIM90

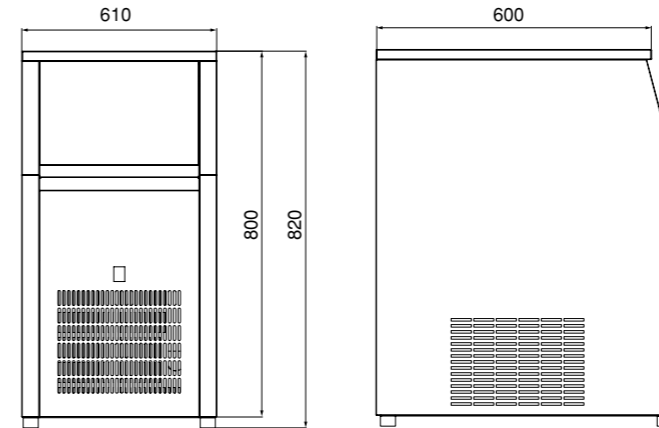

AIM130

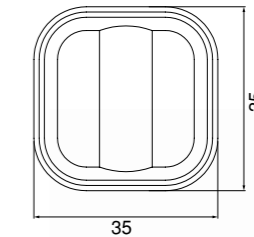
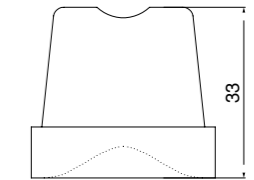

22gr

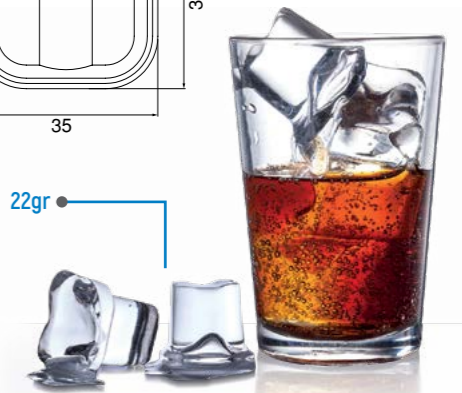

| KOD / CODE  | AIM 90            | AIM 130           |
|---|-------------------|-------------------|
| Günlük Buz Yapma Kapasitesi / Ice Making Capacity Per Day | 85 kg             | 130 kg            |
| Soğutma Sistemi / Cooling System                          | Hava (Air Cooled) | Hava (Air Cooled) |
| Maksimum Güç / Maximum Power                              | 910 W             | 1200 W            |
| İklim Sınıfı / Tropical Class                             | T                 | T                 |
| Ürün Ölçüleri / Product Dimensions (mm)                   | 610 x 600 x 820   | 730 x 750 x 900   |
| Ambalaj Ölçüleri / Packing Dimensions (mm)                | 660 x 650 x 1100  | 780 x 800 x 950   |
| Ürün Ağırlığı / Product Weight                            | 82 kg             | 110 kg            |
| Fiyat / Price   | - €               | - €               |

R290 R290 İstenildiği takdirde fiyatlara %3 ilave edilir. / For R290 Refrigerant gas, price increase is 3%.

AIM

## AIM 250-500

BUZ MAKİNASI  
ICE CUBE MACHINE250KG/GÜN  
250KG/DAY

AIM250

180 KG KAPASİTE  
180 KG CAPACITY

BN200

AIM500

500KG/GÜN  
500KG/DAY220 KG KAPASİTE  
220 KG CAPACITY

BN400

## TEKNİK DETAYLAR / TECHNICAL DETAILS

TR

- Tropikal iklim sınıfı +43 °C
- Temizlik gerektirmeyen kondenser
- Sıfır ODP enjekte 42 kg/ m<sup>3</sup> çevre dostu poliüretan izolasyon
- Antibakteriyel buz saklama alanı
- Manyetik pompa ile sessiz çalışma
- Elektronik kontrol
- Geniş buz depolama alanı
- Ergonomik kapak kulbu
- Patentli nozul sistemi ile daha kısa süreli buz döngüsü

EN

- Tropical class +43 °C
- Stay clear condenser
- Zero ODP injected 42 kg/ m<sup>3</sup> polyurathane insulation
- Antibacterial storage area
- Silent operation with magnetic pump
- Electronic control
- Large ice storage bin
- Ergonomic door handle
- Patented nozzle system provides less cycles

## AIM 250-500

AIM250

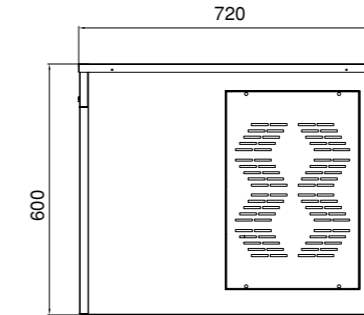
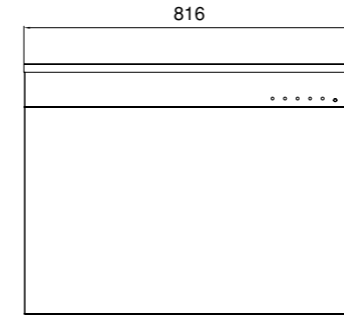

BN200

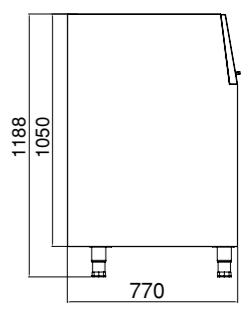
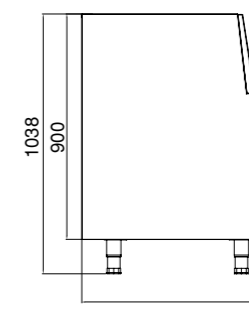

AIM500

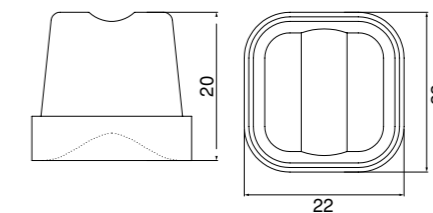
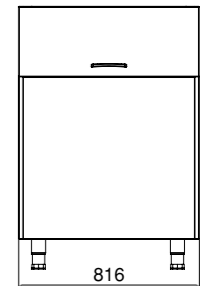
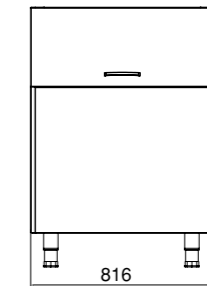
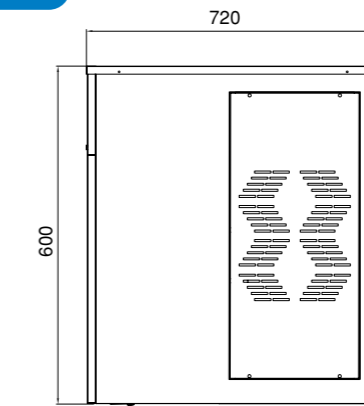
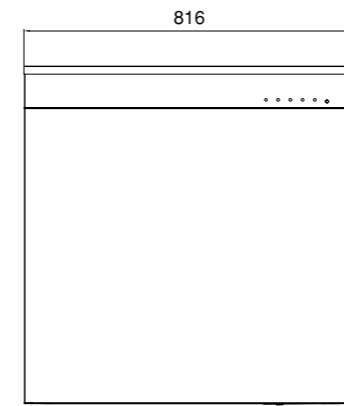

10gr



| KOD / CODE  | BUZ MAKİNELERİ / ICE MAKERS |                   | HAZNELER / ICE BINS |                  |
|---|-----------------------------|-------------------|---------------------|------------------|
|   | AIM 250                     | AIM 400           | BN 200              | BN 400           |
| Günlük Buz Yapma Kapasitesi / Ice Making Capacity Per Day | 250 kg                      | 400 kg            | 180 kg              | 220 kg           |
| Soğutma Sistemi / Cooling System                          | Hava (Air Cooled)           | Hava (Air Cooled) | -                   | -                |
| Maksimum Güç / Maximum Power                              | 1100 W                      | 2440 W            | -                   | -                |
| İklim Sınıfı / Tropical Class                             | T                           | T                 | -                   | -                |
| Ürün Ölçüleri / Product Dimensions (mm)                   | 820 x 720 x 600             | 820 x 720 x 830   | 820 x 770 x 1040    | 820 x 770 x 1200 |
| Ambalaj Ölçüleri / Packing Dimensions (mm)                | 870 x 770 x 750             | 870 x 770 x 980   | 880 x 810 x 1200    | 880 x 810 x 1350 |
| Ürün Ağırlığı / Product Weight                            | 86 kg                       | 117 kg            | 55 kg               | 63 kg            |
| Fiyat / Price   | - €                         | - €               | - €                 | - €              |

R290 İstenildiği takdirde fiyatlara %3 ilave edilir. / For R290 Refrigerant gas, price increase is 3%.

# MODÜLER SOĞUK ODA LAR



# MODULAR COLD ROOMS



# SOĞUTMA ÜNİTELERİ COOLING SYSTEM FOR CHILLERS

# 8 CM PANEL KALINLIKLI ODALAR 8 CM PANEL THICKNESS ROOMS

**NEW  
PRODUCT**



## MONOBLOK SOĞUTMA ÜNİTELERİ MONO-BLOCK COOLING SYSTEM FOR CHILLERS

| KOD / CODE | °C   | HACİM ARALIĞI /<br>VOLUME | € |
|------------|------|---------------------------|---|
| WCM3050    | 0/+8 | 3-5                       | - |
| WCM5075    | 0/+8 | 5-7,5                     | - |
| WCM7510    | 0/+8 | 7,6-10                    | - |
| WCM1015    | 1/+8 | 10-15                     | - |
| WCM1520    | 2/+8 | 15,1-20                   | - |

## MONOBLOK SOĞUTMA ÜNİTELERİ MONO-BLOCK COOLING SYSTEM FOR FREEZER

| KOD / CODE | °C      | HACİM ARALIĞI /<br>VOLUME | € |
|------------|---------|---------------------------|---|
| WFM3050    | 0 / -20 | 3-5                       | - |
| WFM5075    | 0 / -20 | 5-7,5                     | - |
| WFM7510    | 0 / -20 | 7,6-10                    | - |
| WFM1015    | 0 / -20 | 10-15                     | - |
| WFM1520    | 0 / -20 | 15,1-20                   | - |

**NEW  
PRODUCT**



**NEW  
PRODUCT**

## SPLIT SOĞUTMA ÜNİTELERİ SPLIT COOLING SYSTEM FOR CHILLERS

| KOD / CODE | °C     | HACİM ARALIĞI /<br>VOLUME | € |
|------------|--------|---------------------------|---|
| WCS3075    | 0 / +8 | 3-7,5                     | - |
| WCS7515    | 0 / +8 | 7,6-15                    | - |
| WCS1520    | 0 / +8 | 15,1-20                   | - |

## SPLIT SOĞUTMA ÜNİTELERİ SPLIT COOLING SYSTEM FOR FREEZER

| KOD / CODE | °C      | HACİM ARALIĞI /<br>VOLUME | € |
|------------|---------|---------------------------|---|
| WFS3075    | 0 / -20 | 3-7,5                     | - |
| WFS7515    | 0 / -20 | 7,6-15                    | - |
| WFS1520    | 0 / -20 | 15,1-20                   | - |

## TEKNİK DETAYLAR / TECHNICAL DETAILS

### TR

- 80mm veya 120mm Panel Kalınlığı
- 42Kg/m3 densite poliüretan izolasyon.
- Modüler paneller-Kolay Montaj ve ayrılabilir.
- 3 yükseklik 2000/2200/2400, mevcut yerde en yüksek verim.
- İki taraflı kilitleme sistemi, dişi-erkek; mükemmel birleşim, civatasız silikonsuz montaj.
- Tabansız oda seçeneği, arabaların kolay girişi, çıkışı.
- Yuvarlatılmış köşeler, Özel paslanmaz zemin.
- Contalı ve kolay ısıtmalı kapı. Mükemmel kapanım.
- Soğutma bölümünün farklı yerlere yerleştirilebilme özelliği.
- +43 derece ortam sıcaklığında çalışma

### EN

- 80mm or 120mm panel thickness
- 42kg / m3 density polyurethane insulation.
- Modular panels-easily assembled and separated.
- 3 heights 2010/2200/2400, maximum capacity in present floor.
- Two-side locking system, female-male; perfect combination, installation without any bolt or silicone.
- Floorless room option, allowing easy entry and exit for cars.
- Rounded corners and special stainless steel for the floor.
- Door with gasket and heater easily.
- Cooling section unit can be positioned anywhere
- +43 degree ambient working temperatures

# 8 CM PANEL KALINLIKLI ODALAR

## 8 CM PANEL THICKNESS ROOMS

# RAF YERLEŞİMİ

## SHELF LAYOUT

| KOD / CODE | HACİM / VOLUME | DIŞ ÖLÇÜLER /<br>VOLUME<br>EXTERNAL DIMENSIONS | NET KAPI ÖLÇÜSÜ /<br>NET DOOR DIMENSIONS | 360 MM RAFLAR /<br>360 MM SHELVES | 460 MM RAFLAR /<br>460 MM SHELVES | € |
|------------|----------------|--|--|-----------------------------------|-----------------------------------|---|
| WIC1212200 | 2,9            | 1200x1200x2000                                 | 580x1845                                 | 403                               | 411                               | - |
| WIC1215200 | 3,6            | 1200x1500x2000                                 | 580x1845                                 | 443                               | 454                               | - |
| WIC1218200 | 4,3            | 1200x1800x2000                                 | 580x1845                                 | 846                               | 845                               | - |
| WIC1221200 | 5,0            | 1200x2100x2000                                 | 580x1845                                 | 904                               | 885                               | - |
| WIC1224200 | 5,8            | 1200x2400x2000                                 | 580x1845                                 | 965                               | 965                               | - |
| WIC1227200 | 6,5            | 1200x2700x2000                                 | 580x1845                                 | 1.226                             | 1.236                             | - |
| WIC1230200 | 7,2            | 1200x3000x2000                                 | 580x1845                                 | 1.289                             | 1.299                             | - |
| WIC1512200 | 3,6            | 1500x1200x2000                                 | 700x1845                                 | 403                               | 411                               | - |
| WIC1515200 | 4,5            | 1500x1500x2000                                 | 700x1845                                 | 443                               | 454                               | - |
| WIC1518200 | 5,4            | 1500x1800x2000                                 | 700x1845                                 | 886                               | 888                               | - |
| WIC1521200 | 6,3            | 1500x2100x2000                                 | 700x1845                                 | 944                               | 928                               | - |
| WIC1524200 | 7,2            | 1500x2400x2000                                 | 700x1845                                 | 1.005                             | 1.008                             | - |
| WIC1527200 | 8,1            | 1500x2700x2000                                 | 700x1845                                 | 1.266                             | 1.279                             | - |
| WIC1530200 | 9,0            | 1500x3000x2000                                 | 700x1845                                 | 1.329                             | 1.342                             | - |
| WIC1812200 | 4,3            | 1800x1200x2000                                 | 700x1845                                 | 761                               | 411                               | - |
| WIC1815200 | 5,4            | 1800x1500x2000                                 | 700x1845                                 | 801                               | 804                               | - |
| WIC1818200 | 6,5            | 1800x1800x2000                                 | 700x1845                                 | 1.302                             | 1.301                             | - |
| WIC1821200 | 7,6            | 1800x2100x2000                                 | 700x1845                                 | 1.363                             | 1.342                             | - |
| WIC1824200 | 8,6            | 1800x2400x2000                                 | 700x1845                                 | 1.421                             | 1.405                             | - |
| WIC1827200 | 9,7            | 1800x2700x2000                                 | 700x1845                                 | 1.482                             | 1.468                             | - |
| WIC1830200 | 10,8           | 1800x3000x2000                                 | 700x1845                                 | 1.742                             | 1.538                             | - |
| WIC2112200 | 5,0            | 2100x1200x2000                                 | 700x1845                                 | 822                               | 822                               | - |
| WIC2115200 | 6,3            | 2100x1500x2000                                 | 700x1845                                 | 862                               | 865                               | - |
| WIC2118200 | 7,6            | 2100x1800x2000                                 | 700x1845                                 | 1.379                             | 1.356                             | - |
| WIC2121200 | 8,8            | 2100x2100x2000                                 | 700x1845                                 | 1.457                             | 1.669                             | - |
| WIC2124200 | 10,1           | 2100x2400x2000                                 | 700x1845                                 | 1.518                             | 1.732                             | - |
| WIC2127200 | 11,3           | 2100x2700x2000                                 | 700x1845                                 | 1.779                             | 1.795                             | - |
| WIC2130200 | 12,6           | 2100x3000x2000                                 | 700x1845                                 | 1.842                             | 1.865                             | - |
| WIC2412200 | 5,8            | 2400x1200x2000                                 | 700x1845                                 | 858                               | 865                               | - |
| WIC2415200 | 7,2            | 2400x1500x2000                                 | 700x1845                                 | 898                               | 908                               | - |
| WIC2418200 | 8,6            | 2400x1800x2000                                 | 700x1845                                 | 1.415                             | 1.442                             | - |
| WIC2421200 | 10,1           | 2400x2100x2000                                 | 700x1845                                 | 1.794                             | 1.813                             | - |
| WIC2424200 | 11,5           | 2400x2400x2000                                 | 700x1845                                 | 1.878                             | 1.876                             | - |
| WIC2427200 | 13,0           | 2400x2700x2000                                 | 700x1845                                 | 1.939                             | 1.939                             | - |
| WIC2430200 | 14,4           | 2400x3000x2000                                 | 700x1845                                 | 2.167                             | 2.009                             | - |
| WIC2712200 | 6,5            | 2700x1200x2000                                 | 700x1845                                 | 942                               | 928                               | - |
| WIC2715200 | 8,1            | 2700x1500x2000                                 | 700x1845                                 | 982                               | 971                               | - |
| WIC2718200 | 9,7            | 2700x1800x2000                                 | 700x1845                                 | 1.595                             | 1.568                             | - |
| WIC2721200 | 11,3           | 2700x2100x2000                                 | 700x1845                                 | 2.104                             | 2.124                             | - |
| WIC2724200 | 13,0           | 2700x2400x2000                                 | 700x1845                                 | 2.186                             | 2.187                             | - |
| WIC2727200 | 14,6           | 2700x2700x2000                                 | 700x1845                                 | 2.247                             | 2.250                             | - |
| WIC2730200 | 16,2           | 2700x3000x2000                                 | 700x1845                                 | 2.507                             | 2.320                             | - |
| WIC3012200 | 7,2            | 3000x1200x2000                                 | 700x1845                                 | 1.209                             | 998                               | - |
| WIC3015200 | 9,0            | 3000x1500x2000                                 | 700x1845                                 | 1.249                             | 1.041                             | - |
| WIC3018200 | 10,8           | 3000x1800x2000                                 | 700x1845                                 | 2.129                             | 1.708                             | - |
| WIC3021200 | 12,6           | 3000x2100x2000                                 | 700x1845                                 | 2.249                             | 2.250                             | - |
| WIC3024200 | 14,4           | 3000x2400x2000                                 | 700x1845                                 | 2.307                             | 2.313                             | - |
| WIC3027200 | 16,2           | 3000x2700x2000                                 | 700x1845                                 | 2.368                             | 2.376                             | - |
| WIC3030200 | 18,0           | 3000x3000x2000                                 | 700x1845                                 | 2.628                             | 2.446                             | - |

### 36 cm Derinlikteki Raflara Göre Düzen

#### Layout for 36 cm Deep Shelves

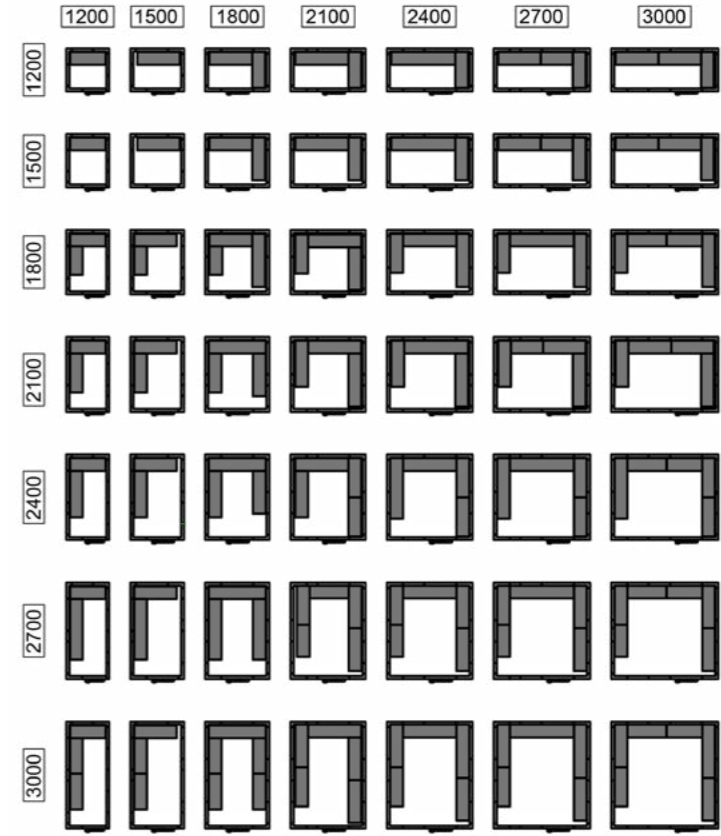

### 46 cm Derinlikteki Raflara Göre Düzen

#### Layout for 46 cm Deep Shelves

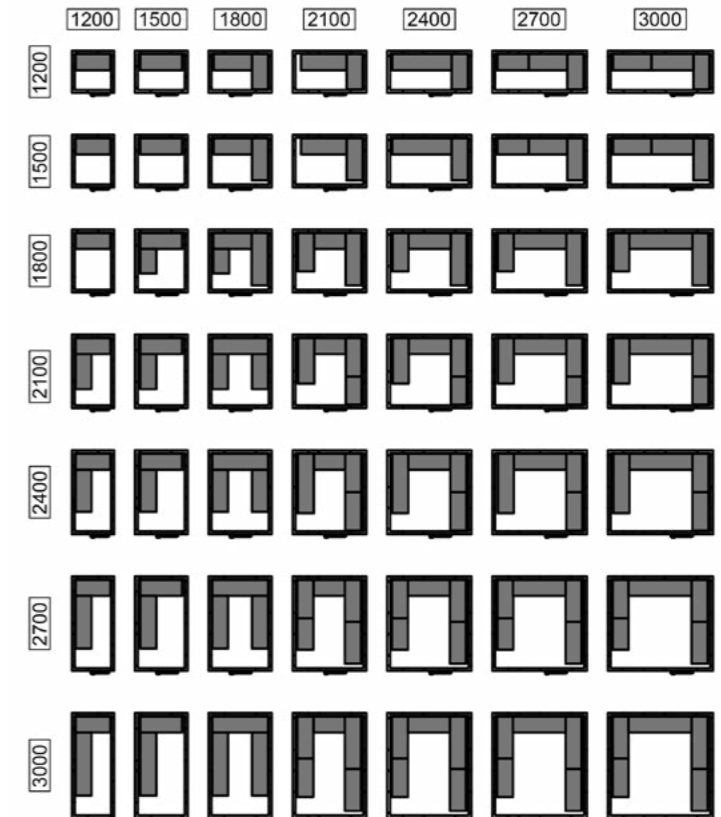

# 8 CM PANEL KALINLIKLIL ODALAR

## 8 CM PANEL THICKNESS ROOMS

# RAF YERLEŞİMİ

## SHELF LAYOUT

| KOD / CODE | HACİM / VOLUME | DIŞ ÖLÇÜLER /<br>VOLUME<br>EXTERNAL DIMENSIONS | NET KAPI ÖLÇÜSÜ /<br>NET DOOR DIMENSIONS | 360 MM RAFLAR /<br>360 MM SHELVES | 460 MM RAFLAR /<br>460 MM SHELVES | € |
|------------|----------------|--|--|-----------------------------------|-----------------------------------|---|
| WIC1212220 | 3,2            | 1200×1200×2200                                 | 580×1845                                 | 403                               | 411                               | - |
| WIC1215220 | 4,0            | 1200×1500×2200                                 | 580×1845                                 | 443                               | 454                               | - |
| WIC1218220 | 4,8            | 1200×1800×2200                                 | 580×1845                                 | 846                               | 845                               | - |
| WIC1221220 | 5,5            | 1200×2100×2200                                 | 580×1845                                 | 904                               | 885                               | - |
| WIC1224220 | 6,3            | 1200×2400×2200                                 | 580×1845                                 | 965                               | 965                               | - |
| WIC1227220 | 7,1            | 1200×2700×2200                                 | 580×1845                                 | 1.226                             | 1.236                             | - |
| WIC1230220 | 7,9            | 1200×3000×2200                                 | 580×1845                                 | 1.289                             | 1.299                             | - |
| WIC1512220 | 4,0            | 1500×1200×2200                                 | 700×1845                                 | 403                               | 411                               | - |
| WIC1515220 | 5,0            | 1500×1500×2200                                 | 700×1845                                 | 443                               | 454                               | - |
| WIC1518220 | 5,9            | 1500×1800×2200                                 | 700×1845                                 | 886                               | 888                               | - |
| WIC1521220 | 6,9            | 1500×2100×2200                                 | 700×1845                                 | 944                               | 928                               | - |
| WIC1524220 | 7,9            | 1500×2400×2200                                 | 700×1845                                 | 1.005                             | 1.008                             | - |
| WIC1527220 | 8,9            | 1500×2700×2200                                 | 700×1845                                 | 1.266                             | 1.279                             | - |
| WIC1530220 | 9,9            | 1500×3000×2200                                 | 700×1845                                 | 1.329                             | 1.342                             | - |
| WIC1812220 | 4,8            | 1800×1200×2200                                 | 700×1845                                 | 761                               | 411                               | - |
| WIC1815220 | 5,9            | 1800×1500×2200                                 | 700×1845                                 | 801                               | 804                               | - |
| WIC1818220 | 7,1            | 1800×1800×2200                                 | 700×1845                                 | 1.302                             | 1.301                             | - |
| WIC1821220 | 8,3            | 1800×2100×2200                                 | 700×1845                                 | 1.363                             | 1.342                             | - |
| WIC1824220 | 9,5            | 1800×2400×2200                                 | 700×1845                                 | 1.421                             | 1.405                             | - |
| WIC1827220 | 10,7           | 1800×2700×2200                                 | 700×1845                                 | 1.482                             | 1.468                             | - |
| WIC1830220 | 11,9           | 1800×3000×2200                                 | 700×1845                                 | 1.742                             | 1.538                             | - |
| WIC2112220 | 5,5            | 2100×1200×2200                                 | 700×1845                                 | 822                               | 822                               | - |
| WIC2115220 | 6,9            | 2100×1500×2200                                 | 700×1845                                 | 862                               | 865                               | - |
| WIC2118220 | 8,3            | 2100×1800×2200                                 | 700×1845                                 | 1.379                             | 1.356                             | - |
| WIC2121220 | 9,7            | 2100×2100×2200                                 | 700×1845                                 | 1.457                             | 1.669                             | - |
| WIC2124220 | 11,1           | 2100×2400×2200                                 | 700×1845                                 | 1.518                             | 1.732                             | - |
| WIC2127220 | 12,5           | 2100×2700×2200                                 | 700×1845                                 | 1.779                             | 1.795                             | - |
| WIC2130220 | 13,9           | 2100×3000×2200                                 | 700×1845                                 | 1.842                             | 1.865                             | - |
| WIC2412220 | 6,3            | 2400×1200×2200                                 | 700×1845                                 | 858                               | 865                               | - |
| WIC2415220 | 7,9            | 2400×1500×2200                                 | 700×1845                                 | 898                               | 908                               | - |
| WIC2418220 | 9,5            | 2400×1800×2200                                 | 700×1845                                 | 1.415                             | 1.442                             | - |
| WIC2421220 | 11,1           | 2400×2100×2200                                 | 700×1845                                 | 1.794                             | 1.813                             | - |
| WIC2424220 | 12,7           | 2400×2400×2200                                 | 700×1845                                 | 1.878                             | 1.876                             | - |
| WIC2427220 | 14,3           | 2400×2700×2200                                 | 700×1845                                 | 1.939                             | 1.939                             | - |
| WIC2430220 | 15,8           | 2400×3000×2200                                 | 700×1845                                 | 2.167                             | 2.009                             | - |
| WIC2712220 | 7,1            | 2700×1200×2200                                 | 700×1845                                 | 942                               | 928                               | - |
| WIC2715220 | 8,9            | 2700×1500×2200                                 | 700×1845                                 | 982                               | 971                               | - |
| WIC2718220 | 10,7           | 2700×1800×2200                                 | 700×1845                                 | 1.595                             | 1.568                             | - |
| WIC2721220 | 12,5           | 2700×2100×2200                                 | 700×1845                                 | 2.104                             | 2.124                             | - |
| WIC2724220 | 14,3           | 2700×2400×2200                                 | 700×1845                                 | 2.186                             | 2.187                             | - |
| WIC2727220 | 16,0           | 2700×2700×2200                                 | 700×1845                                 | 2.247                             | 2.250                             | - |
| WIC2730220 | 17,8           | 2700×3000×2200                                 | 700×1845                                 | 2.507                             | 2.320                             | - |
| WIC3012220 | 7,9            | 3000×1200×2200                                 | 700×1845                                 | 1.209                             | 998                               | - |
| WIC3015220 | 9,9            | 3000×1500×2200                                 | 700×1845                                 | 1.249                             | 1.041                             | - |
| WIC3018220 | 11,9           | 3000×1800×2200                                 | 700×1845                                 | 2.129                             | 1.708                             | - |
| WIC3021220 | 13,9           | 3000×2100×2200                                 | 700×1845                                 | 2.249                             | 2.250                             | - |
| WIC3024220 | 15,8           | 3000×2400×2200                                 | 700×1845                                 | 2.307                             | 2.313                             | - |
| WIC3027220 | 17,8           | 3000×2700×2200                                 | 700×1845                                 | 2.368                             | 2.376                             | - |
| WIC3030220 | 19,8           | 3000×3000×2200                                 | 700×1845                                 | 2.628                             | 2.446                             | - |

### 36 cm Derinlikteki Raflara Göre Düzen

#### Layout for 36 cm Deep Shelves

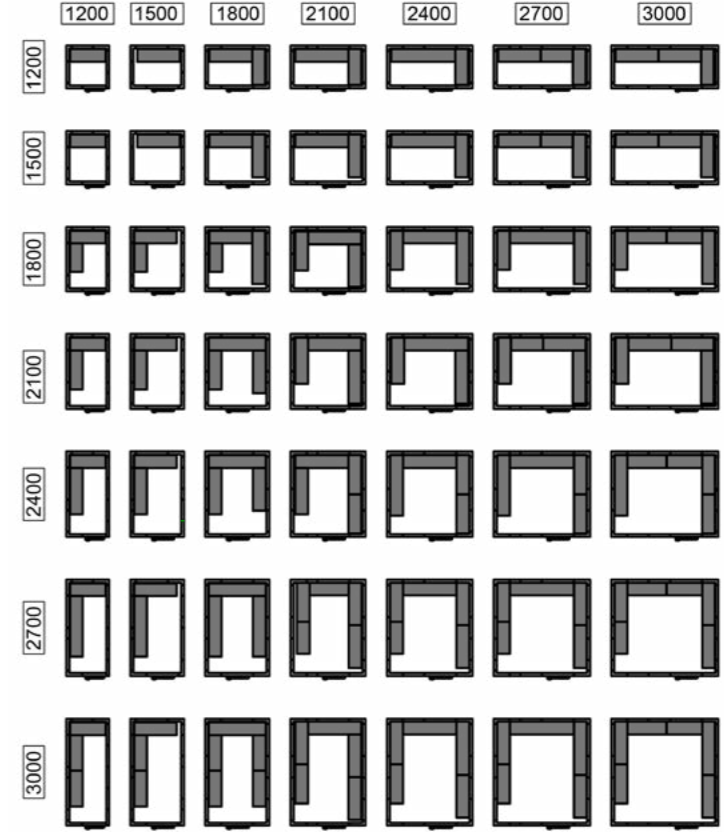

### 46 cm Derinlikteki Raflara Göre Düzen

#### Layout for 46 cm Deep Shelves

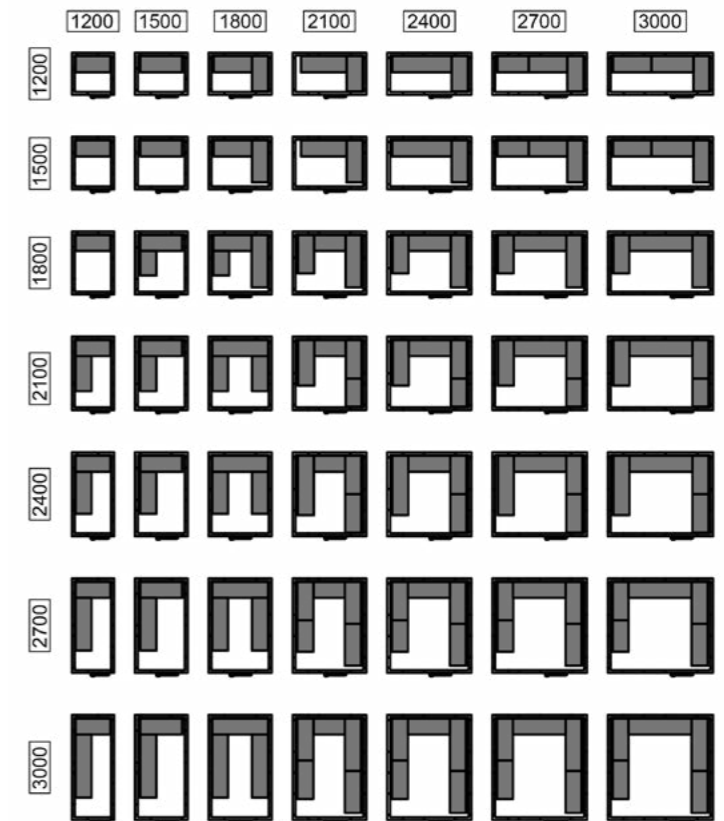

# 8 CM PANEL KALINLIKLIL ODALAR

## 8 CM PANEL THICKNESS ROOMS

# RAF YERLEŐİMİ

## SHELF LAYOUT

| KOD / CODE | HACİM / VOLUME | DIŐ ÖLÇÜLER /<br>VOLUME<br>EXTERNAL DIMENSIONS | NET KAPI ÖLÇÜŐÜ /<br>NET DOOR DIMENSIONS | 360 MM RAFLAR /<br>360 MM SHELVES | 460 MM RAFLAR /<br>460 MM SHELVES | € |
|------------|----------------|--|--|-----------------------------------|-----------------------------------|---|
| WIC1212240 | 3,5            | 1200x1200x2400                                 | 580x1845                                 | 403                               | 411                               | - |
| WIC1215240 | 4,3            | 1200x1500x2400                                 | 580x1845                                 | 443                               | 454                               | - |
| WIC1218240 | 5,2            | 1200x1800x2400                                 | 580x1845                                 | 846                               | 845                               | - |
| WIC1221240 | 6,0            | 1200x2100x2400                                 | 580x1845                                 | 904                               | 885                               | - |
| WIC1224240 | 6,9            | 1200x2400x2400                                 | 580x1845                                 | 965                               | 965                               | - |
| WIC1227240 | 7,8            | 1200x2700x2400                                 | 580x1845                                 | 1.226                             | 1.236                             | - |
| WIC1230240 | 8,6            | 1200x3000x2400                                 | 580x1845                                 | 1.289                             | 1.299                             | - |
| WIC1512240 | 4,3            | 1500x1200x2400                                 | 700x1845                                 | 403                               | 411                               | - |
| WIC1515240 | 5,4            | 1500x1500x2400                                 | 700x1845                                 | 443                               | 454                               | - |
| WIC1518240 | 6,5            | 1500x1800x2400                                 | 700x1845                                 | 886                               | 888                               | - |
| WIC1521240 | 7,6            | 1500x2100x2400                                 | 700x1845                                 | 944                               | 928                               | - |
| WIC1524240 | 8,6            | 1500x2400x2400                                 | 700x1845                                 | 1.005                             | 1.008                             | - |
| WIC1527240 | 9,7            | 1500x2700x2400                                 | 700x1845                                 | 1.266                             | 1.279                             | - |
| WIC1530240 | 10,8           | 1500x3000x2400                                 | 700x1845                                 | 1.329                             | 1.342                             | - |
| WIC1812240 | 5,2            | 1800x1200x2400                                 | 700x1845                                 | 761                               | 411                               | - |
| WIC1815240 | 6,5            | 1800x1500x2400                                 | 700x1845                                 | 801                               | 804                               | - |
| WIC1818240 | 7,8            | 1800x1800x2400                                 | 700x1845                                 | 1.302                             | 1.301                             | - |
| WIC1821240 | 9,1            | 1800x2100x2400                                 | 700x1845                                 | 1.363                             | 1.342                             | - |
| WIC1824240 | 10,4           | 1800x2400x2400                                 | 700x1845                                 | 1.421                             | 1.405                             | - |
| WIC1827240 | 11,7           | 1800x2700x2400                                 | 700x1845                                 | 1.482                             | 1.468                             | - |
| WIC1830240 | 13,0           | 1800x3000x2400                                 | 700x1845                                 | 1.742                             | 1.538                             | - |
| WIC2112240 | 6,0            | 2100x1200x2400                                 | 700x1845                                 | 822                               | 822                               | - |
| WIC2115240 | 7,6            | 2100x1500x2400                                 | 700x1845                                 | 862                               | 865                               | - |
| WIC2118240 | 9,1            | 2100x1800x2400                                 | 700x1845                                 | 1.379                             | 1.356                             | - |
| WIC2121240 | 10,6           | 2100x2100x2400                                 | 700x1845                                 | 1.457                             | 1.669                             | - |
| WIC2124240 | 12,1           | 2100x2400x2400                                 | 700x1845                                 | 1.518                             | 1.732                             | - |
| WIC2127240 | 13,6           | 2100x2700x2400                                 | 700x1845                                 | 1.779                             | 1.795                             | - |
| WIC2130240 | 15,1           | 2100x3000x2400                                 | 700x1845                                 | 1.842                             | 1.865                             | - |
| WIC2412240 | 6,9            | 2400x1200x2400                                 | 700x1845                                 | 858                               | 865                               | - |
| WIC2415240 | 8,6            | 2400x1500x2400                                 | 700x1845                                 | 898                               | 908                               | - |
| WIC2418240 | 10,4           | 2400x1800x2400                                 | 700x1845                                 | 1.415                             | 1.442                             | - |
| WIC2421240 | 12,1           | 2400x2100x2400                                 | 700x1845                                 | 1.794                             | 1.813                             | - |
| WIC2424240 | 13,8           | 2400x2400x2400                                 | 700x1845                                 | 1.878                             | 1.876                             | - |
| WIC2427240 | 15,6           | 2400x2700x2400                                 | 700x1845                                 | 1.939                             | 1.939                             | - |
| WIC2430240 | 17,3           | 2400x3000x2400                                 | 700x1845                                 | 2.167                             | 2.009                             | - |
| WIC2712240 | 7,8            | 2700x1200x2400                                 | 700x1845                                 | 942                               | 928                               | - |
| WIC2715240 | 9,7            | 2700x1500x2400                                 | 700x1845                                 | 982                               | 971                               | - |
| WIC2718240 | 11,7           | 2700x1800x2400                                 | 700x1845                                 | 1.595                             | 1.568                             | - |
| WIC2721240 | 13,6           | 2700x2100x2400                                 | 700x1845                                 | 2.104                             | 2.124                             | - |
| WIC2724240 | 15,6           | 2700x2400x2400                                 | 700x1845                                 | 2.186                             | 2.187                             | - |
| WIC2727240 | 17,5           | 2700x2700x2400                                 | 700x1845                                 | 2.247                             | 2.250                             | - |
| WIC2730240 | 19,4           | 2700x3000x2400                                 | 700x1845                                 | 2.507                             | 2.320                             | - |
| WIC3012240 | 8,6            | 3000x1200x2400                                 | 700x1845                                 | 1.209                             | 998                               | - |
| WIC3015240 | 10,8           | 3000x1500x2400                                 | 700x1845                                 | 1.249                             | 1.041                             | - |
| WIC3018240 | 13,0           | 3000x1800x2400                                 | 700x1845                                 | 2.129                             | 1.708                             | - |
| WIC3021240 | 15,1           | 3000x2100x2400                                 | 700x1845                                 | 2.249                             | 2.250                             | - |
| WIC3024240 | 17,3           | 3000x2400x2400                                 | 700x1845                                 | 2.307                             | 2.313                             | - |
| WIC3027240 | 19,4           | 3000x2700x2400                                 | 700x1845                                 | 2.368                             | 2.376                             | - |
| WIC3030240 | 21,6           | 3000x3000x2400                                 | 700x1845                                 | 2.628                             | 2.446                             | - |

### 36 cm Derinlikteki Raflara Göre Düzen

Layout for 36 cm Deep Shelves

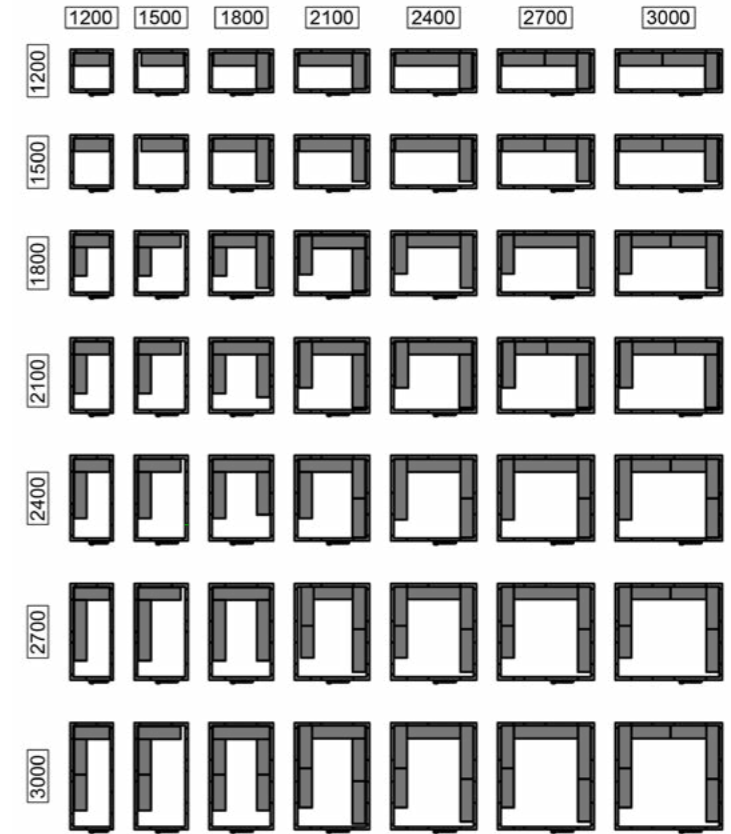

### 46 cm Derinlikteki Raflara Göre Düzen

Layout for 46 cm Deep Shelves

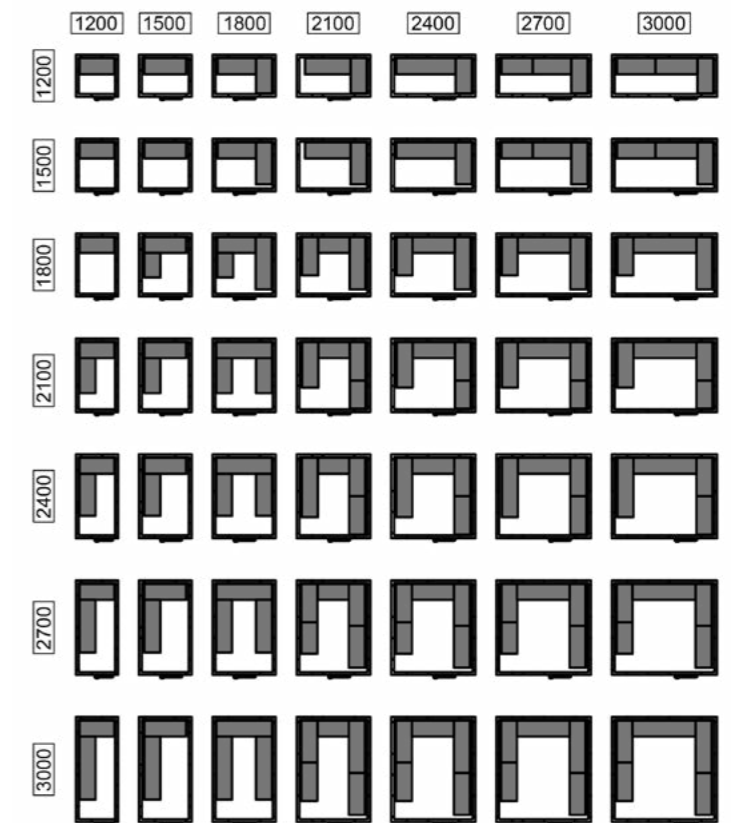

# 12 CM PANEL KALINLIKLIL ODALAR

## 12 CM PANEL THICKNESS ROOMS

# RAF YERLEŐİMİ

## SHELF LAYOUT

| KOD / CODE | HACİM / VOLUME | DIŐ ÖLÇÜLER /<br>VOLUME<br>EXTERNAL DIMENSIONS | NET KAPI ÖLÇÜSÜ /<br>NET DOOR DIMENSIONS | 360 MM RAFLAR /<br>360 MM SHELVES | 460 MM RAFLAR /<br>460 MM SHELVES | € |
|------------|----------------|--|--|-----------------------------------|-----------------------------------|---|
| WIF1212200 | 2,9            | 1200x1200x2000                                 | 580x1845                                 | 358                               | 370                               | - |
| WIF1215200 | 3,6            | 1200x1500x2000                                 | 580x1845                                 | 443                               | 434                               | - |
| WIF1218200 | 4,3            | 1200x1800x2000                                 | 580x1845                                 | 777                               | 781                               | - |
| WIF1221200 | 5,0            | 1200x2100x2000                                 | 580x1845                                 | 813                               | 844                               | - |
| WIF1224200 | 5,8            | 1200x2400x2000                                 | 580x1845                                 | 897                               | 924                               | - |
| WIF1227200 | 6,5            | 1200x2700x2000                                 | 580x1845                                 | 1.157                             | 1.192                             | - |
| WIF1230200 | 7,2            | 1200x3000x2000                                 | 580x1845                                 | 1.220                             | 1.238                             | - |
| WIF1512200 | 3,6            | 1500x1200x2000                                 | 700x1845                                 | 358                               | 370                               | - |
| WIF1515200 | 4,5            | 1500x1500x2000                                 | 700x1845                                 | 443                               | 434                               | - |
| WIF1518200 | 5,4            | 1500x1800x2000                                 | 700x1845                                 | 838                               | 845                               | - |
| WIF1521200 | 6,3            | 1500x2100x2000                                 | 700x1845                                 | 874                               | 908                               | - |
| WIF1524200 | 7,2            | 1500x2400x2000                                 | 700x1845                                 | 958                               | 988                               | - |
| WIF1527200 | 8,1            | 1500x2700x2000                                 | 700x1845                                 | 1.218                             | 1.256                             | - |
| WIF1530200 | 9,0            | 1500x3000x2000                                 | 700x1845                                 | 1.281                             | 1.302                             | - |
| WIF1812200 | 4,3            | 1800x1200x2000                                 | 700x1845                                 | 699                               | 720                               | - |
| WIF1815200 | 5,4            | 1800x1500x2000                                 | 700x1845                                 | 784                               | 784                               | - |
| WIF1818200 | 6,5            | 1800x1800x2000                                 | 700x1845                                 | 1.343                             | 885                               | - |
| WIF1821200 | 7,6            | 1800x2100x2000                                 | 700x1845                                 | 1.297                             | 1.319                             | - |
| WIF1824200 | 8,6            | 1800x2400x2000                                 | 700x1845                                 | 1.381                             | 1.362                             | - |
| WIF1827200 | 9,7            | 1800x2700x2000                                 | 700x1845                                 | 1.641                             | 1.445                             | - |
| WIF1830200 | 10,8           | 1800x3000x2000                                 | 700x1845                                 | 1.704                             | 1.515                             | - |
| WIF2112200 | 5,0            | 2100x1200x2000                                 | 700x1845                                 | 738                               | 740                               | - |
| WIF2115200 | 6,3            | 2100x1500x2000                                 | 700x1845                                 | 823                               | 804                               | - |
| WIF2118200 | 7,6            | 2100x1800x2000                                 | 700x1845                                 | 1.284                             | 1.368                             | - |
| WIF2121200 | 8,8            | 2100x2100x2000                                 | 700x1845                                 | 1.420                             | 1.452                             | - |
| WIF2124200 | 10,1           | 2100x2400x2000                                 | 700x1845                                 | 1.472                             | 1.495                             | - |
| WIF2127200 | 11,3           | 2100x2700x2000                                 | 700x1845                                 | 1.556                             | 1.578                             | - |
| WIF2130200 | 12,6           | 2100x3000x2000                                 | 700x1845                                 | 1.823                             | 1.648                             | - |
| WIF2412200 | 5,8            | 2400x1200x2000                                 | 700x1845                                 | 801                               | 804                               | - |
| WIF2415200 | 7,2            | 2400x1500x2000                                 | 700x1845                                 | 886                               | 868                               | - |
| WIF2418200 | 8,6            | 2400x1800x2000                                 | 700x1845                                 | 1.399                             | 1.690                             | - |
| WIF2421200 | 10,1           | 2400x2100x2000                                 | 700x1845                                 | 1.764                             | 1.770                             | - |
| WIF2424200 | 11,5           | 2400x2400x2000                                 | 700x1845                                 | 1.816                             | 1.813                             | - |
| WIF2427200 | 13,0           | 2400x2700x2000                                 | 700x1845                                 | 1.900                             | 1.896                             | - |
| WIF2430200 | 14,4           | 2400x3000x2000                                 | 700x1845                                 | 2.167                             | 1.966                             | - |
| WIF2712200 | 6,5            | 2700x1200x2000                                 | 700x1845                                 | 875                               | 887                               | - |
| WIF2715200 | 8,1            | 2700x1500x2000                                 | 700x1845                                 | 960                               | 951                               | - |
| WIF2718200 | 9,7            | 2700x1800x2000                                 | 700x1845                                 | 1.557                             | 1.813                             | - |
| WIF2721200 | 11,3           | 2700x2100x2000                                 | 700x1845                                 | 2.067                             | 2.080                             | - |
| WIF2724200 | 13,0           | 2700x2400x2000                                 | 700x1845                                 | 2.119                             | 2.123                             | - |
| WIF2727200 | 14,6           | 2700x2700x2000                                 | 700x1845                                 | 2.203                             | 2.206                             | - |
| WIF2730200 | 16,2           | 2700x3000x2000                                 | 700x1845                                 | 2.470                             | 2.276                             | - |
| WIF3012200 | 7,2            | 3000x1200x2000                                 | 700x1845                                 | 1.193                             | 957                               | - |
| WIF3015200 | 9,0            | 3000x1500x2000                                 | 700x1845                                 | 1.278                             | 1.021                             | - |
| WIF3018200 | 10,8           | 3000x1800x2000                                 | 700x1845                                 | 2.246                             | 1.946                             | - |
| WIF3021200 | 12,6           | 3000x2100x2000                                 | 700x1845                                 | 2.148                             | 2.207                             | - |
| WIF3024200 | 14,4           | 3000x2400x2000                                 | 700x1845                                 | 2.200                             | 2.250                             | - |
| WIF3027200 | 16,2           | 3000x2700x2000                                 | 700x1845                                 | 2.284                             | 2.333                             | - |
| WIF3030200 | 18,0           | 3000x3000x2000                                 | 700x1845                                 | 2.551                             | 2.403                             | - |

### 36 cm Derinlikteki Raflara Göre Düzen

#### Layout for 36 cm Deep Shelves

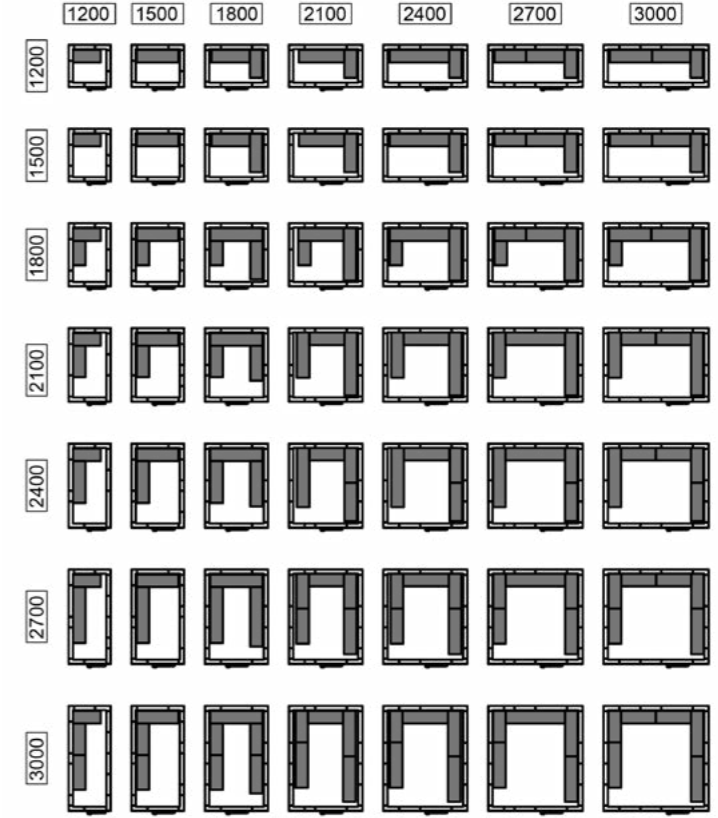

### 46 cm Derinlikteki Raflara Göre Düzen

#### Layout for 46 cm Deep Shelves

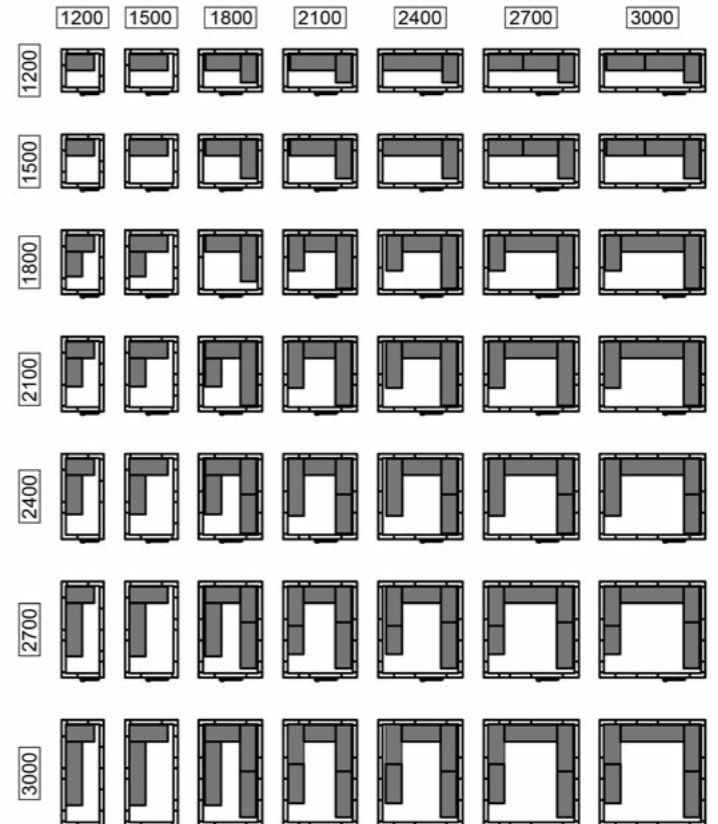

# 12 CM PANEL KALINLIKLIL ODALAR

## 12 CM PANEL THICKNESS ROOMS

# RAF YERLEŞİMİ

## SHELF LAYOUT

| KOD / CODE | HACİM / VOLUME | DIŞ ÖLÇÜLER / VOLUME EXTERNAL DIMENSIONS | NET KAPI ÖLÇÜSÜ / NET DOOR DIMENSIONS | 360 MM RAFLAR / 360 MM SHELVES | 460 MM RAFLAR / 460 MM SHELVES | € |
|------------|----------------|--|---------------------------------------|--------------------------------|--------------------------------|---|
| WIF1212220 | 3,2            | 1200x1200x2200                           | 580x1845                              | 358                            | 370                            | - |
| WIF1215220 | 4,0            | 1200x1500x2200                           | 580x1845                              | 443                            | 434                            | - |
| WIF1218220 | 4,8            | 1200x1800x2200                           | 580x1845                              | 777                            | 781                            | - |
| WIF1221220 | 5,5            | 1200x2100x2200                           | 580x1845                              | 813                            | 844                            | - |
| WIF1224220 | 6,3            | 1200x2400x2200                           | 580x1845                              | 897                            | 924                            | - |
| WIF1227220 | 7,1            | 1200x2700x2200                           | 580x1845                              | 1157                           | 1192                           | - |
| WIF1230220 | 7,9            | 1200x3000x2200                           | 580x1845                              | 1.220                          | 1.238                          | - |
| WIF1512220 | 4,0            | 1500x1200x2200                           | 700x1845                              | 358                            | 370                            | - |
| WIF1515220 | 5,0            | 1500x1500x2200                           | 700x1845                              | 443                            | 434                            | - |
| WIF1518220 | 5,9            | 1500x1800x2200                           | 700x1845                              | 838                            | 845                            | - |
| WIF1521220 | 6,9            | 1500x2100x2200                           | 700x1845                              | 874                            | 908                            | - |
| WIF1524220 | 7,9            | 1500x2400x2200                           | 700x1845                              | 958                            | 988                            | - |
| WIF1527220 | 8,9            | 1500x2700x2200                           | 700x1845                              | 1.218                          | 1.256                          | - |
| WIF1530220 | 9,9            | 1500x3000x2200                           | 700x1845                              | 1.281                          | 1.302                          | - |
| WIF1812220 | 4,8            | 1800x1200x2200                           | 700x1845                              | 699                            | 720                            | - |
| WIF1815220 | 5,9            | 1800x1500x2200                           | 700x1845                              | 784                            | 784                            | - |
| WIF1818220 | 7,1            | 1800x1800x2200                           | 700x1845                              | 1.343                          | 885                            | - |
| WIF1821220 | 8,3            | 1800x2100x2200                           | 700x1845                              | 1.297                          | 1.319                          | - |
| WIF1824220 | 9,5            | 1800x2400x2200                           | 700x1845                              | 1.381                          | 1.362                          | - |
| WIF1827220 | 10,7           | 1800x2700x2200                           | 700x1845                              | 1.641                          | 1.445                          | - |
| WIF1830220 | 11,9           | 1800x3000x2200                           | 700x1845                              | 1.704                          | 1.515                          | - |
| WIF2112220 | 5,5            | 2100x1200x2200                           | 700x1845                              | 738                            | 740                            | - |
| WIF2115220 | 6,9            | 2100x1500x2200                           | 700x1845                              | 823                            | 804                            | - |
| WIF2118220 | 8,3            | 2100x1800x2200                           | 700x1845                              | 1.284                          | 1.368                          | - |
| WIF2121220 | 9,7            | 2100x2100x2200                           | 700x1845                              | 1.420                          | 1.452                          | - |
| WIF2124220 | 11,1           | 2100x2400x2200                           | 700x1845                              | 1.472                          | 1.495                          | - |
| WIF2127220 | 12,5           | 2100x2700x2200                           | 700x1845                              | 1.556                          | 1.578                          | - |
| WIF2130220 | 13,9           | 2100x3000x2200                           | 700x1845                              | 1.823                          | 1.648                          | - |
| WIF2412220 | 6,3            | 2400x1200x2200                           | 700x1845                              | 801                            | 804                            | - |
| WIF2415220 | 7,9            | 2400x1500x2200                           | 700x1845                              | 886                            | 868                            | - |
| WIF2418220 | 9,5            | 2400x1800x2200                           | 700x1845                              | 1.399                          | 1.690                          | - |
| WIF2421220 | 11,1           | 2400x2100x2200                           | 700x1845                              | 1.764                          | 1.770                          | - |
| WIF2424220 | 12,7           | 2400x2400x2200                           | 700x1845                              | 1.816                          | 1.813                          | - |
| WIF2427220 | 14,3           | 2400x2700x2200                           | 700x1845                              | 1.900                          | 1.896                          | - |
| WIF2430220 | 15,8           | 2400x3000x2200                           | 700x1845                              | 2.167                          | 1.966                          | - |
| WIF2712220 | 7,1            | 2700x1200x2200                           | 700x1845                              | 875                            | 887                            | - |
| WIF2715220 | 8,9            | 2700x1500x2200                           | 700x1845                              | 960                            | 951                            | - |
| WIF2718220 | 10,7           | 2700x1800x2200                           | 700x1845                              | 1.557                          | 1.813                          | - |
| WIF2721220 | 12,5           | 2700x2100x2200                           | 700x1845                              | 2.067                          | 2.080                          | - |
| WIF2724220 | 14,3           | 2700x2400x2200                           | 700x1845                              | 2.119                          | 2.123                          | - |
| WIF2727220 | 16,0           | 2700x2700x2200                           | 700x1845                              | 2.203                          | 2.206                          | - |
| WIF2730220 | 17,8           | 2700x3000x2200                           | 700x1845                              | 2.470                          | 2.276                          | - |
| WIF3012220 | 7,9            | 3000x1200x2200                           | 700x1845                              | 1.193                          | 957                            | - |
| WIF3015220 | 9,9            | 3000x1500x2200                           | 700x1845                              | 1.278                          | 1.021                          | - |
| WIF3018220 | 11,9           | 3000x1800x2200                           | 700x1845                              | 2.246                          | 1.946                          | - |
| WIF3021220 | 13,9           | 3000x2100x2200                           | 700x1845                              | 2.148                          | 2.207                          | - |
| WIF3024220 | 15,8           | 3000x2400x2200                           | 700x1845                              | 2.200                          | 2.250                          | - |
| WIF3027220 | 17,8           | 3000x2700x2200                           | 700x1845                              | 2.284                          | 2.333                          | - |
| WIF3030220 | 19,8           | 3000x3000x2200                           | 700x1845                              | 2.551                          | 2.403                          | - |

### 36 cm Derinlikteki Raflara Göre Düzen

#### Layout for 36 cm Deep Shelves

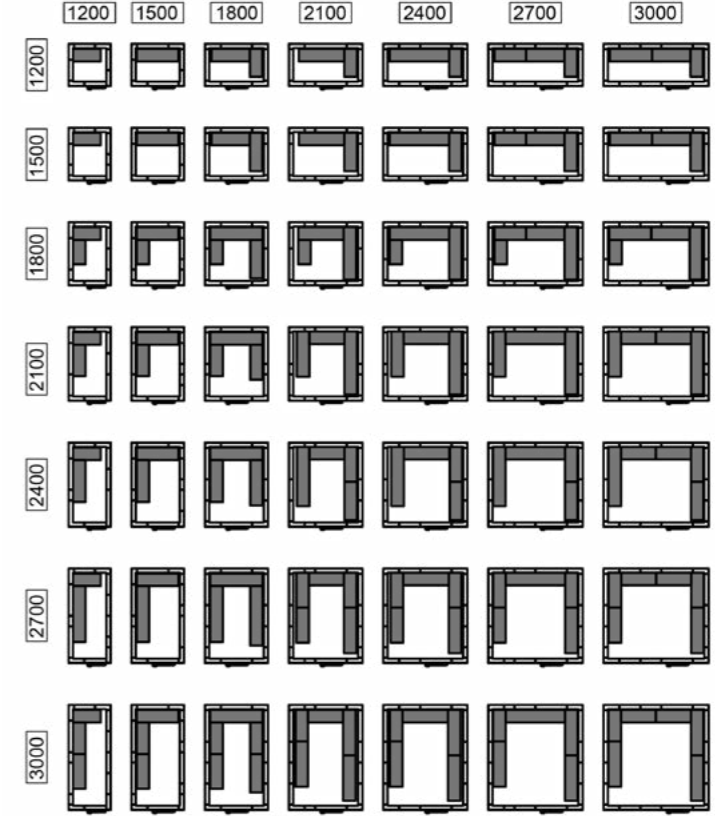

### 46 cm Derinlikteki Raflara Göre Düzen

#### Layout for 46 cm Deep Shelves

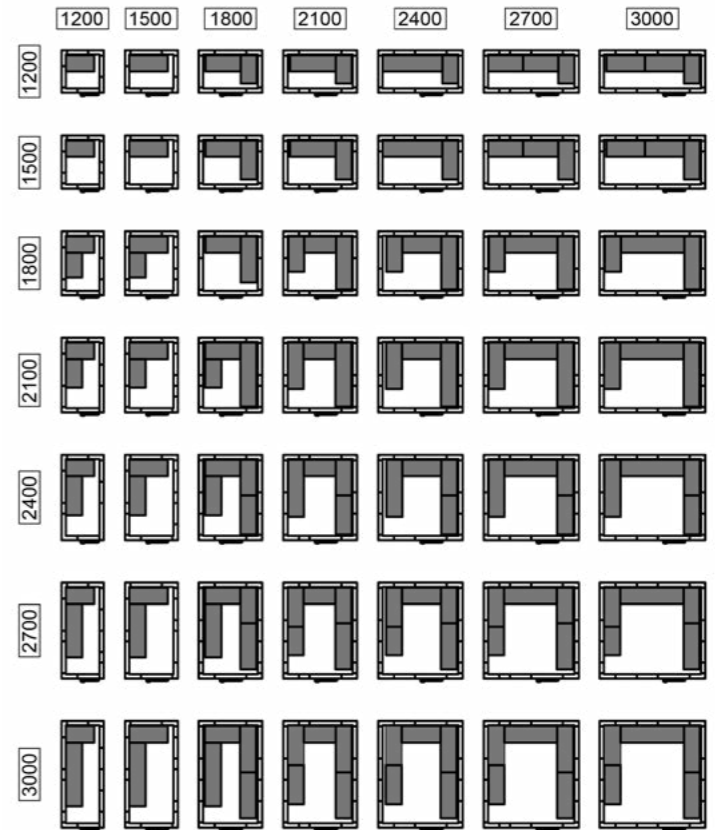

# 12 CM PANEL KALINLIKLI ODALAR

## 12 CM PANEL THICKNESS ROOMS

# RAF YERLEŞİMİ

## SHELF LAYOUT

| KOD / CODE | HACİM / VOLUME | DIŞ ÖLÇÜLER /<br>VOLUME<br>EXTERNAL DIMENSIONS | NET KAPI ÖLÇÜSÜ /<br>NET DOOR DIMENSIONS | 360 MM RAFLAR /<br>360 MM SHELVES | 460 MM RAFLAR /<br>460 MM SHELVES | € |
|------------|----------------|--|--|-----------------------------------|-----------------------------------|---|
| WIF1212240 | 3,5            | 1200x1200x2400                                 | 580x1845                                 | 358                               | 370                               | - |
| WIF1215240 | 4,3            | 1200x1500x2400                                 | 580x1845                                 | 443                               | 434                               | - |
| WIF1218240 | 5,2            | 1200x1800x2400                                 | 580x1845                                 | 777                               | 781                               | - |
| WIF1221240 | 6,0            | 1200x2100x2400                                 | 580x1845                                 | 813                               | 844                               | - |
| WIF1224240 | 6,9            | 1200x2400x2400                                 | 580x1845                                 | 897                               | 924                               | - |
| WIF1227240 | 7,8            | 1200x2700x2400                                 | 580x1845                                 | 1157                              | 1192                              | - |
| WIF1230240 | 8,6            | 1200x3000x2400                                 | 580x1845                                 | 1.220                             | 1.238                             | - |
| WIF1512240 | 4,3            | 1500x1200x2400                                 | 700x1845                                 | 358                               | 370                               | - |
| WIF1515240 | 5,4            | 1500x1500x2400                                 | 700x1845                                 | 443                               | 434                               | - |
| WIF1518240 | 6,5            | 1500x1800x2400                                 | 700x1845                                 | 838                               | 845                               | - |
| WIF1521240 | 7,6            | 1500x2100x2400                                 | 700x1845                                 | 874                               | 908                               | - |
| WIF1524240 | 8,6            | 1500x2400x2400                                 | 700x1845                                 | 958                               | 988                               | - |
| WIF1527240 | 9,7            | 1500x2700x2400                                 | 700x1845                                 | 1.218                             | 1.256                             | - |
| WIF1530240 | 10,8           | 1500x3000x2400                                 | 700x1845                                 | 1.281                             | 1.302                             | - |
| WIF1812240 | 5,2            | 1800x1200x2400                                 | 700x1845                                 | 699                               | 720                               | - |
| WIF1815240 | 6,5            | 1800x1500x2400                                 | 700x1845                                 | 784                               | 784                               | - |
| WIF1818240 | 7,8            | 1800x1800x2400                                 | 700x1845                                 | 1.343                             | 885                               | - |
| WIF1821240 | 9,1            | 1800x2100x2400                                 | 700x1845                                 | 1.297                             | 1.319                             | - |
| WIF1824240 | 10,4           | 1800x2400x2400                                 | 700x1845                                 | 1.381                             | 1.362                             | - |
| WIF1827240 | 11,7           | 1800x2700x2400                                 | 700x1845                                 | 1.641                             | 1.445                             | - |
| WIF1830240 | 13,0           | 1800x3000x2400                                 | 700x1845                                 | 1.704                             | 1.515                             | - |
| WIF2112240 | 6,0            | 2100x1200x2400                                 | 700x1845                                 | 738                               | 740                               | - |
| WIF2115240 | 7,6            | 2100x1500x2400                                 | 700x1845                                 | 823                               | 804                               | - |
| WIF2118240 | 9,1            | 2100x1800x2400                                 | 700x1845                                 | 1.284                             | 1.368                             | - |
| WIF2121240 | 10,6           | 2100x2100x2400                                 | 700x1845                                 | 1.420                             | 1.452                             | - |
| WIF2124240 | 12,1           | 2100x2400x2400                                 | 700x1845                                 | 1.472                             | 1.495                             | - |
| WIF2127240 | 13,6           | 2100x2700x2400                                 | 700x1845                                 | 1.556                             | 1.578                             | - |
| WIF2130240 | 15,1           | 2100x3000x2400                                 | 700x1845                                 | 1.823                             | 1.648                             | - |
| WIF2412240 | 6,9            | 2400x1200x2400                                 | 700x1845                                 | 801                               | 804                               | - |
| WIF2415240 | 8,6            | 2400x1500x2400                                 | 700x1845                                 | 886                               | 868                               | - |
| WIF2418240 | 10,4           | 2400x1800x2400                                 | 700x1845                                 | 1.399                             | 1.690                             | - |
| WIF2421240 | 12,1           | 2400x2100x2400                                 | 700x1845                                 | 1.764                             | 1.770                             | - |
| WIF2424240 | 13,8           | 2400x2400x2400                                 | 700x1845                                 | 1.816                             | 1.813                             | - |
| WIF2427240 | 15,6           | 2400x2700x2400                                 | 700x1845                                 | 1.900                             | 1.896                             | - |
| WIF2430240 | 17,3           | 2400x3000x2400                                 | 700x1845                                 | 2.167                             | 1.966                             | - |
| WIF2712240 | 7,8            | 2700x1200x2400                                 | 700x1845                                 | 875                               | 887                               | - |
| WIF2715240 | 9,7            | 2700x1500x2400                                 | 700x1845                                 | 960                               | 951                               | - |
| WIF2718240 | 11,7           | 2700x1800x2400                                 | 700x1845                                 | 1.557                             | 1.813                             | - |
| WIF2721240 | 13,6           | 2700x2100x2400                                 | 700x1845                                 | 2.067                             | 2.080                             | - |
| WIF2724240 | 15,6           | 2700x2400x2400                                 | 700x1845                                 | 2.119                             | 2.123                             | - |
| WIF2727240 | 17,5           | 2700x2700x2400                                 | 700x1845                                 | 2.203                             | 2.206                             | - |
| WIF2730240 | 19,4           | 2700x3000x2400                                 | 700x1845                                 | 2.470                             | 2.276                             | - |
| WIF3012240 | 8,6            | 3000x1200x2400                                 | 700x1845                                 | 1.193                             | 957                               | - |
| WIF3015240 | 10,8           | 3000x1500x2400                                 | 700x1845                                 | 1.278                             | 1.021                             | - |
| WIF3018240 | 13,0           | 3000x1800x2400                                 | 700x1845                                 | 2.246                             | 1.946                             | - |
| WIF3021240 | 15,1           | 3000x2100x2400                                 | 700x1845                                 | 2.148                             | 2.207                             | - |
| WIF3024240 | 17,3           | 3000x2400x2400                                 | 700x1845                                 | 2.200                             | 2.250                             | - |
| WIF3027240 | 19,4           | 3000x2700x2400                                 | 700x1845                                 | 2.284                             | 2.333                             | - |
| WIF3030240 | 21,6           | 3000x3000x2400                                 | 700x1845                                 | 2.551                             | 2.403                             | - |

### 36 cm Derinlikteki Raflara Göre Düzen

#### Layout for 36 cm Deep Shelves

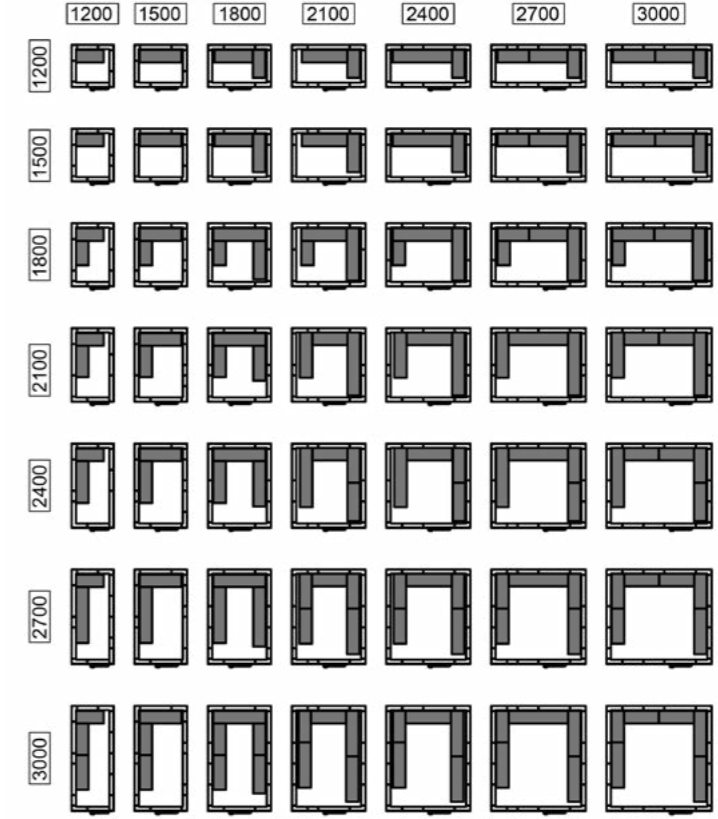

### 46 cm Derinlikteki Raflara Göre Düzen

#### Layout for 46 cm Deep Shelves

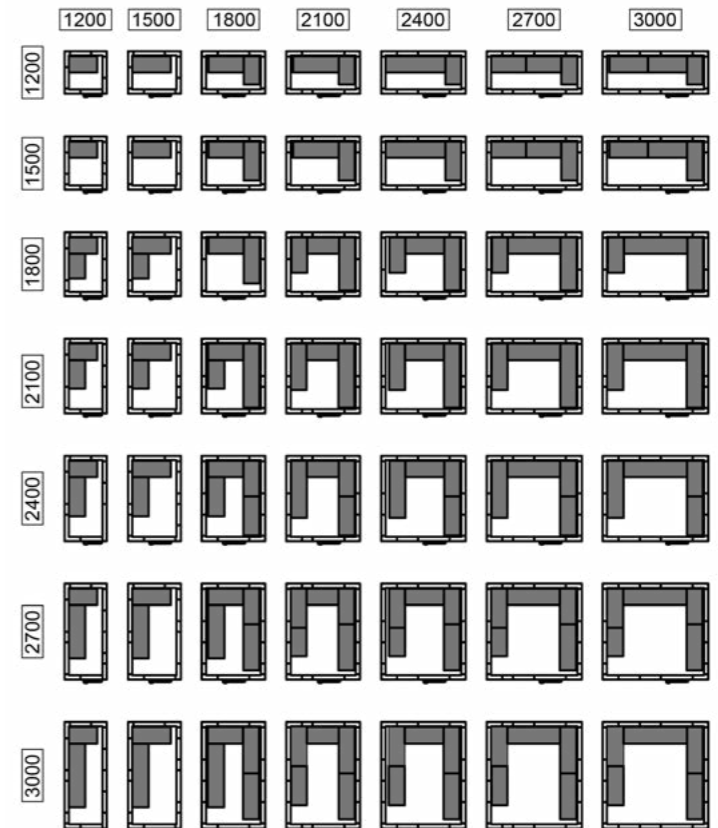

# YIKAMA EKİPMANLARI



## DISHWASHER EQUIPMENT





# AIM IW35

BARDAK YIKAMA MAKİNASI - 35x35 BASKET  
GLASSWASHER - 35x35 BASKET

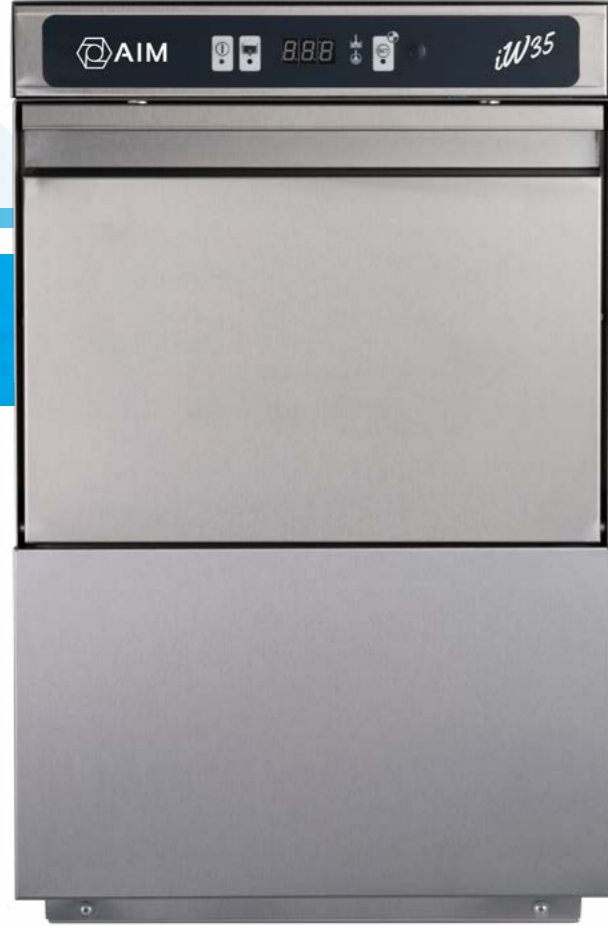

## TEKNİK DETAYLAR / TECHNICAL DETAILS

### TR

- Dijital kontrol ile kullanım kolaylığı
- 120sn - 150sn - 180sn üç ayrı yıkama programı
- 50° Yıkama suyu sıcaklığı
- 75° Durulama suyu sıcaklığı
- 3/4 İnç su giriş bağlantısı
- 15Lt Yıkama tankı kapasitesi
- 4Lt Boyler tankı kapasitesi
- 3Lt Su tüketimi
- 1,5 Kw Yıkama rezistans gücü
- 2,2 Kw Boyler rezistans gücü
- 3 Kw Max. Makina gücü

### EN

- Easy Operation with Digital Control.
- 120 sec. , 150 sec. , 180 sec. 3 different washing programme.
- 50° Boiler Temperature
- 75° Washing Tank Temperature
- 3/4 Inch water inlet connection
- 15Lt Water Tank Capacity
- 4Lt Boiler Tank Capacity
- 3Lt water Consumption
- 1,5 Kw Tank heater power.
- 2,2 Kw Boiler heater power.
- 3 Kw Max. Total power.

## AIM IW35

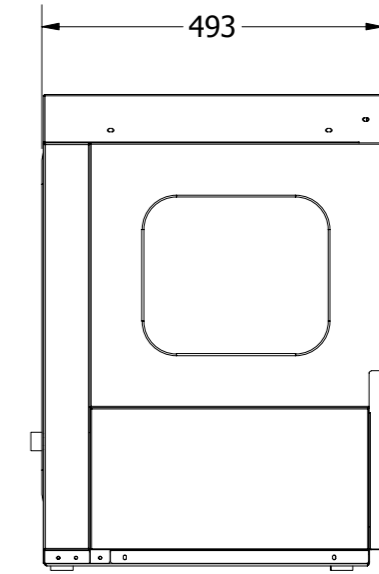
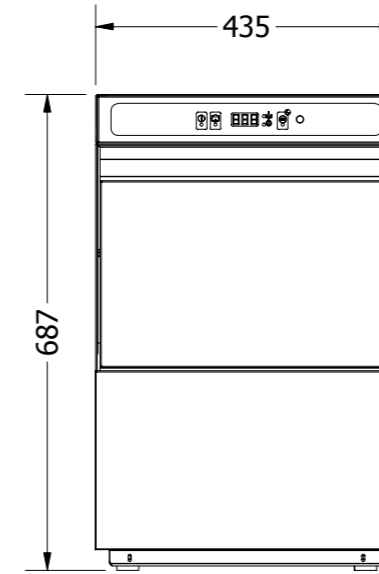

## DİJİTAL PANEL DETAYLARI / DIGITAL PANNEL DETAILS

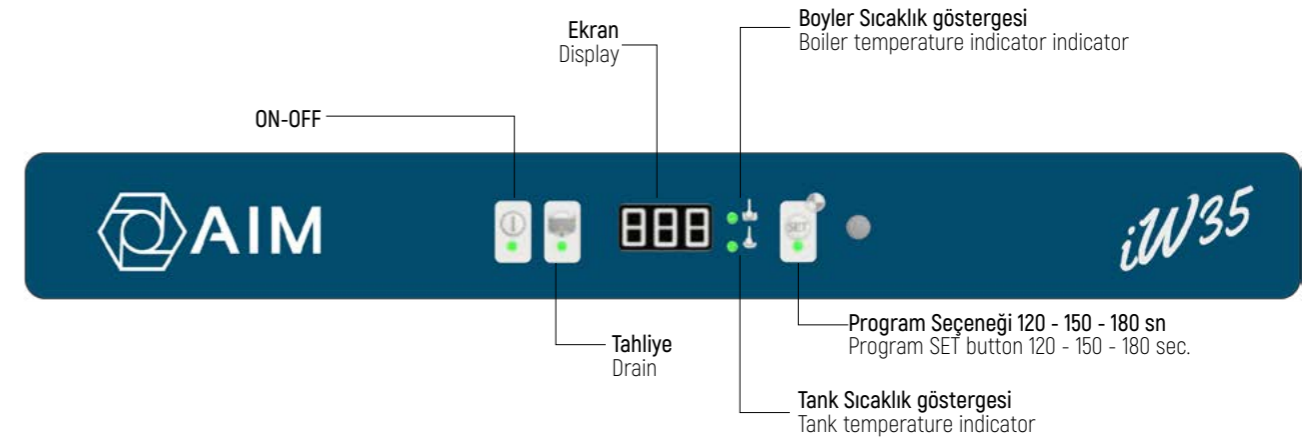

| KOD / CODE | DRENAJ POMPASI<br>DRAIN PUMP | PARLATICI POMPASI<br>RINSE-AID PUMP | DETERJAN POMPASI<br>DETERGENT PUMP |
|------------|------------------------------|-------------------------------------|------------------------------------|
| IW35-P     | ✓                            | ✓                                   | -                                  |
| IW35       | ✓                            | -                                   | -                                  |

| ÜRÜN ADI / PRODUCT NAME               | KOD / CODE | Ürün Boyutları<br>(MM) | KAPASİTE<br>CAPACITY<br>(Bardak/Saat - Glass/Hour) | Güç<br>Power | Ağırlık<br>Weight (kg) | Fiyat<br>Price (€) |
|---------------------------------------|------------|------------------------|--|--------------|------------------------|--------------------|
| Bardak Yıkama Makinesi<br>Glasswasher | IW35-P     | 435x492x687            | 350  | 230V - 50Hz  | 48                     | -                  |
| Bardak Yıkama Makinesi<br>Glasswasher | IW35       | 435x492x687            | 350  | 230V - 50Hz  | 48                     | -                  |

AIM

## AIM IW40

BARDAK YIKAMA MAKİNASI - 40x40 BASKET  
GLASSWASHER - 40x40 BASKET

## TEKNİK DETAYLAR / TECHNICAL DETAILS

TR

- Dijital kontrol ile kullanım kolaylığı
- 90sn - 120sn - 180sn üç ayrı yıkama programı
- 50° Yıkama suyu sıcaklığı
- 82° Durulama suyu sıcaklığı
- 3/4 İnç su giriş bağlantısı
- 18Lt Yıkama tankı kapasitesi
- 5Lt Boyler tankı kapasitesi
- 3Lt Su tüketimi
- 1,8Kw Yıkama rezistans gücü
- 2,2Kw Boyler rezistans gücü
- 2,5Kw Max. Makina gücü

EN

- Easy Operation with Digital Control.
- 90 sec. , 120 sec. , 180 sec. 3 different washing programme.
- 50° Boiler Temperature
- 82° Washing Tank Temperature
- 3/4 Inch water inlet connection
- 18 Lt Water Tank Capacity
- 5 Lt Boiler Tank Capacity
- 3 Lt water Consumption
- 1,8 Kw Tank heater power.
- 2,2 Kw Boiler heater power.
- 2,5 Kw Max. Total power.

## AIM IW40

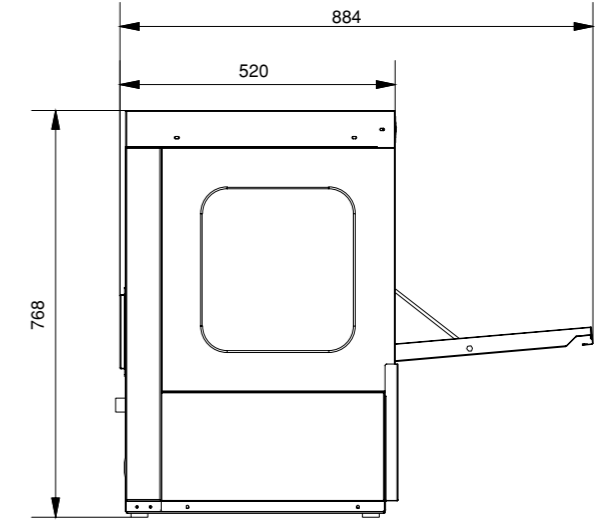
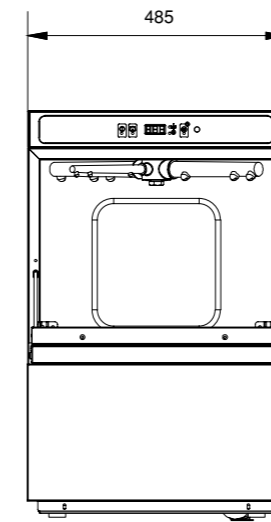

## DİJİTAL PANEL DETAYLARI / DIGITAL PANNEL DETAILS

| KOD / CODE | DRENAJ POMPASI<br>DRAIN PUMP | PARLATICI POMPASI<br>RINSE-AID PUMP | DETERJAN POMPASI<br>DETERGENT PUMP |
|------------|------------------------------|-------------------------------------|------------------------------------|
| IW40-P     | ✓                            | ✓                                   | ✓                                  |
| IW40       | ✓                            |                                     |                                    |

| ÜRÜN ADI / PRODUCT NAME               | KOD / CODE | ÜÇGEN<br>(MM) | KAPASİTE<br>CAPACITY<br>[Bardak/Saat - Glass/Hour] | KAPASİTE<br>CAPACITY<br>[Tabak/Saat - Plate/Hour] | 230V - 50Hz | kg | € |
|---------------------------------------|------------|---------------|--|---|-------------|----|---|
| Bardak Yıkama Makinesi<br>Glasswasher | IW40-P     | 485x520x760   | 1000   | 400   | 230V - 50Hz | 48 | - |
| Bardak Yıkama Makinesi<br>Glasswasher | IW40       | 485x520x760   | 1000   | 400   | 230V - 50Hz | 48 | - |

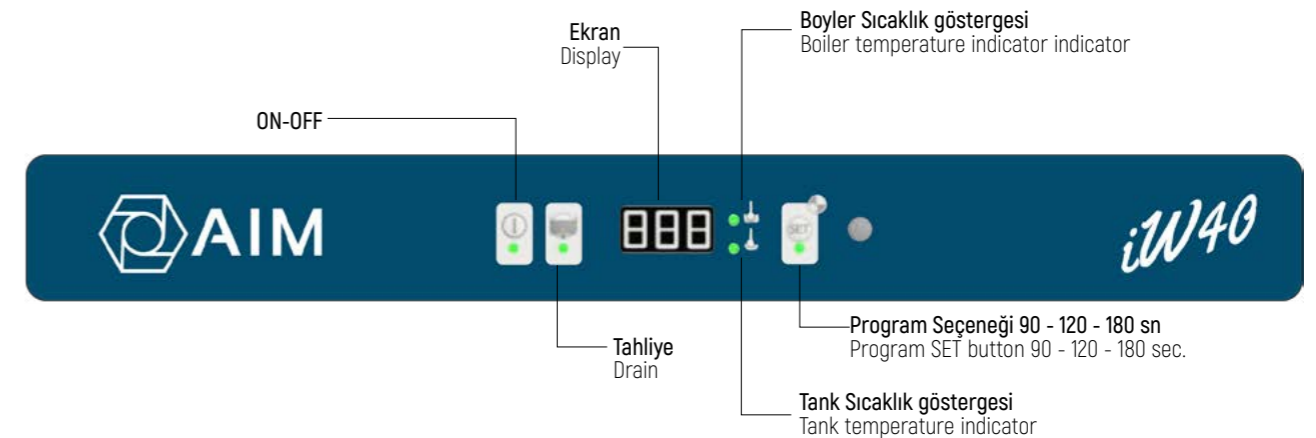



# AIM IW50

SET ALTI BULAŞIK YIKAMA MAKİNASI - 50x50 BASKET  
UNDERCOUNTER DISWASHER - 50x50 BASKET



## TEKNİK DETAYLAR / TECHNICAL DETAILS

### TR

- Dijital kontrol ile kullanım kolaylığı
- 90sn - 120sn - 180sn üç ayrı yıkama programı
- 55° Yıkama suyu sıcaklığı
- 82° Durulama suyu sıcaklığı
- 3/4 İnç su giriş bağlantısı
- 33Lt Yıkama tankı kapasitesi
- 6Lt Boyler tankı kapasitesi
- 3 Lt Su tüketimi
- 2 Kw Yıkama rezistans gücü
- 2,2 Kw Boyler rezistans gücü
- 5,20 Kw Max. Makina gücü

### EN

- Easy Operation with Digital Control.
- 90 sec. , 120 sec. , 180 sec. 3 different washing programme.
- 55° Boiler Temperature
- 82° Washing Tank Temperature
- 3/4 Inch water inlet connection
- 18 Lt Water Tank Capacity
- 5 Lt Boiler Tank Capacity
- 3 Lt water Consumption
- 2 Kw Tank heater power.
- 2,2 Kw Boiler heater power.
- 5,20 Kw Max. Total power.

## AIM IW50

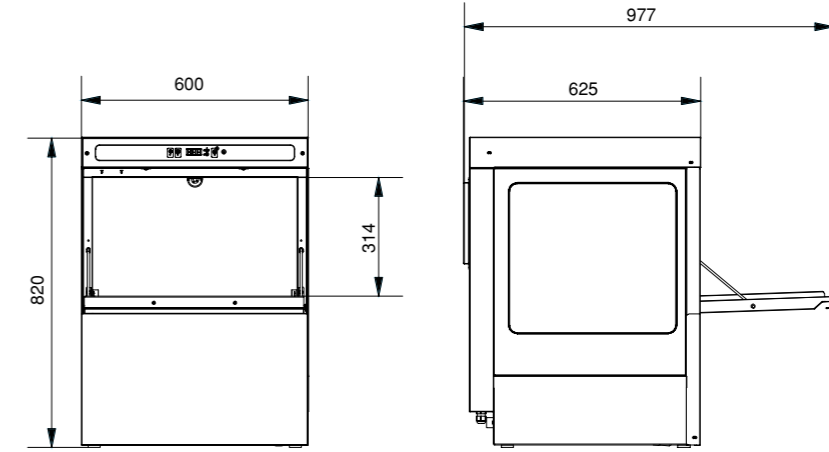

## DİJİTAL PANEL DETAYLARI / DIGITAL PANNEL DETAILS

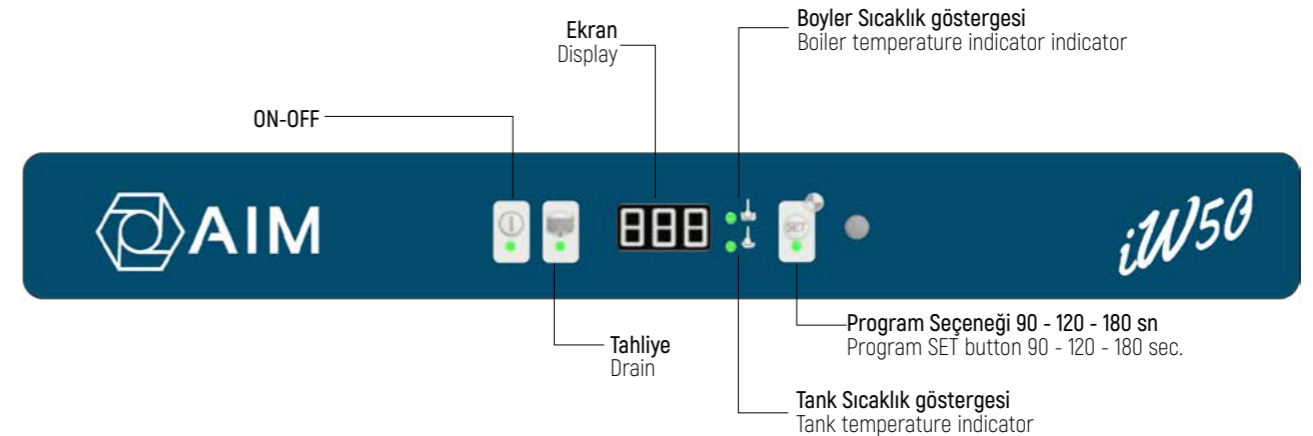

| KOD / CODE | DRENAJ POMPASI<br>DRAIN PUMP | PARLATICI POMPASI<br>RINSE-AID PUMP | DETERJAN POMPASI<br>DETERGENT PUMP |
|------------|------------------------------|-------------------------------------|------------------------------------|
| IW50-P     | ✓                            | ✓                                   | ✓                                  |
| IW50       | ✓                            |                                     |                                    |

| ÜRÜN ADI / PRODUCT NAME                                     | KOD / CODE | ÜÇGEN<br>(MM) | KAPASİTE<br>CAPACITY<br>(Tabak/Saat - Plate/Hour) | ⏻           | ⚖  | € |
|---|------------|---------------|---|-------------|----|---|
| Set Altı Bulaşık Yıkama Makinesi<br>Undercounter Dishwasher | IW50-P     | 600x628x825   | 500   | 230V - 50Hz | 67 | - |
| Set Altı Bulaşık Yıkama Makinesi<br>Undercounter Dishwasher | IW50       | 600x628x825   | 500   | 230V - 50Hz | 65 | - |



# AIM IW100

GİYOTİN TİP BULAŞIK YIKAMA MAKİNESİ - 50x50 BASKET  
HOOD TYPE DISHWASHER - 50x50 BASKET



| KOD / CODE | DRENAJ POMPASI<br>DRAIN PUMP | PARLATICI POMPASI<br>RINSE-AID PUMP | DETERJAN POMPASI<br>DETERGENT PUMP |
|------------|------------------------------|-------------------------------------|------------------------------------|
| IW100-P    |                              | ✓                                   | ✓                                  |
| IW100      |                              |                                     |                                    |

| ÜRÜN ADI / PRODUCT NAME                                     | KOD / CODE | Ürün Boyutları (MM)<br>[MM] | Kapasite<br>CAPACITY<br>[Bardak/Saat - Glass/Hour] | Kapasite<br>CAPACITY<br>[Tabak/Saat - Plate/Hour] | Power<br>[W]     | Weight<br>[kg] | Price<br>[€] |
|---|------------|-----------------------------|--|---|------------------|----------------|--------------|
| Giyotin Tip Bulaşık Yıkama Makinesi<br>Hood Type Dishwasher | IW100-P    | 690x787x1475                | 1000   | 1000  | 400V / 3N / 50Hz | 90             | -            |
| Giyotin Tip Bulaşık Yıkama Makinesi<br>Hood Type Dishwasher | IW100      | 690x787x1475                | 1000   | 1000  | 400V / 3N / 50Hz | 90             | -            |

## TEKNİK DETAYLAR / TECHNICAL DETAILS

TR

- Dijital kontrol ile kullanım kolaylığı
- 60sn - 90sn - 180sn üç ayrı yıkama programı
- 55° Yıkama suyu sıcaklığı
- 82° Durulama suyu sıcaklığı
- 3/4 İnç su giriş bağlantısı
- 70-37 Lt Yıkama tankı kapasitesi
- 8-12 Lt Boyler tankı kapasitesi
- 3 Lt Su tüketimi
- 3 Kw Yıkama rezistans gücü
- 9 Kw Boyler rezistans gücü
- 9,7 Kw Max. Makina gücü

EN

- Easy Operation with Digital Control.
- 60 sec. , 90 sec. , 180 sec. 3 different washing programme.
- 55° Boiler Temperature
- 82° Washing Tank Temperature
- 3/4 Inch water inlet connection
- 70-37 Lt Water Tank Capacity
- 8-12 Lt Boiler Tank Capacity
- 3 Lt water Consumption
- 3 Kw Tank heater power.
- 9 Kw Boiler heater power.
- 9,7 Kw Max. Total power.

## AIM IW100

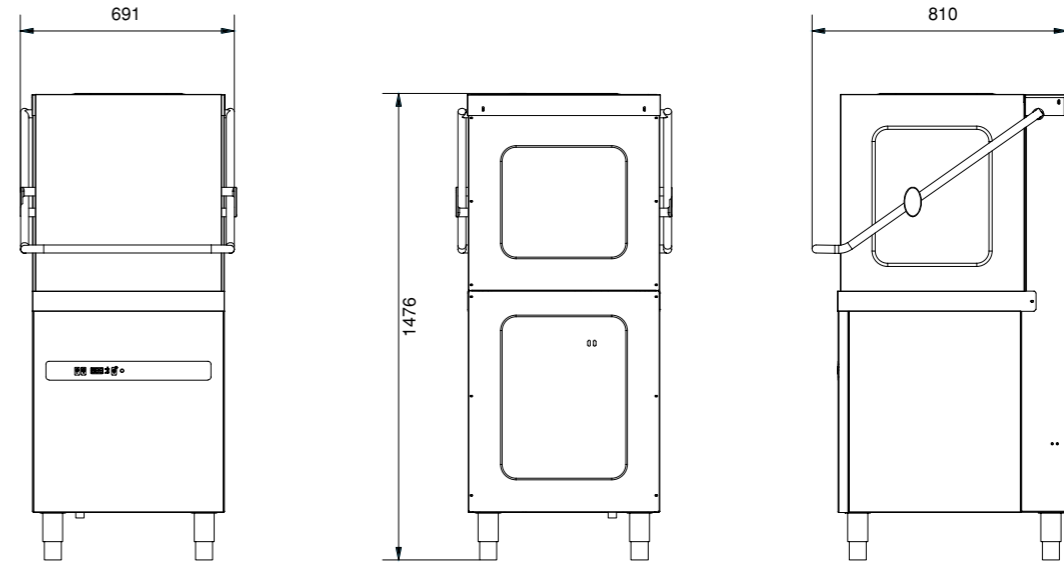

## DİJİTAL PANEL DETAYLARI / DIGITAL PANNEL DETAILS

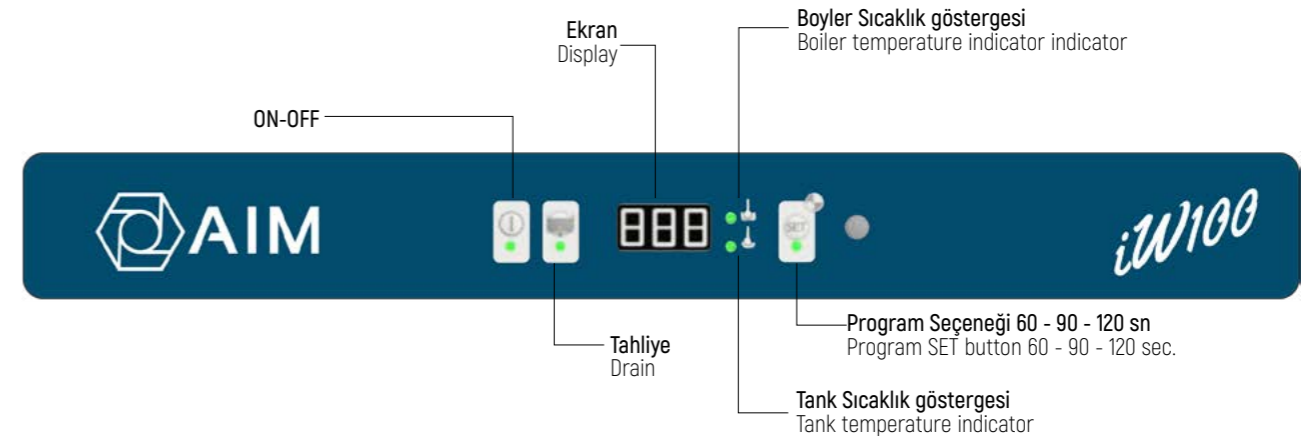



**BYM ÇIKIŞ TEZGAHI**  
EXIT TABLE FOR DISHWASHER

| ÜRÜN ADI / PRODUCT NAME   | KOD / CODE    |               | ↑<br>[MM]    | € |
|---|---------------|---------------|--------------|---|
| BYM Çıkış Tezgahı -Taban Rafı<br>Dishwasher Outlet Table-W/Undershelf | AIM-807585-L  | AIM-807585-R  | 800x750x850  | - |
| BYM Çıkış Tezgahı -Taban Rafı<br>Dishwasher Outlet Table-W/Undershelf | AIM-1207585-L | AIM-1207585-R | 1200x750x850 | - |

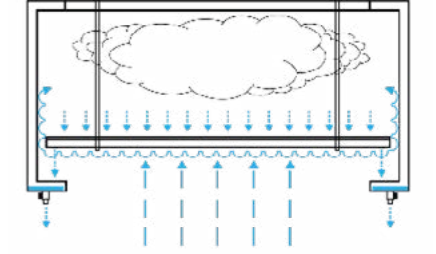

**BYM DAVLUMBAZ**  
CONDENSATION HOOD

| ÜRÜN ADI / PRODUCT NAME           | KOD / CODE       |  | ↑<br>[MM]     | € |
|-----------------------------------|------------------|--|---------------|---|
| BYM Davlumbaz - Condensation Hood | AIM-10015040-CON |  | 1000x1000x400 | - |
| BYM Davlumbaz - Condensation Hood | AIM-15015040-CON |  | 1500x1500x400 | - |



**BYM GİRİŞ TEZGAHI**  
INLET TABLE FOR DISHWASHER

| ÜRÜN ADI / PRODUCT NAME                      | KOD / CODE     |                | ↑<br>[MM]    | € |
|--|----------------|----------------|--------------|---|
| BYM Çıkış Tezgahı<br>Dishwasher Outlet Table | AIM-757585-1L  | AIM-757585-1R  | 750x750x850  | - |
| BYM Çıkış Tezgahı<br>Dishwasher Outlet Table | AIM-1207585-1L | AIM-1207585-1R | 1200x750x850 | - |
| BYM Çıkış Tezgahı<br>Dishwasher Outlet Table | AIM-1407585-2L | AIM-1407585-2R | 1400x750x850 | - |



**BASKET RAFI**  
BASE FOR DISHWASHER

| ÜRÜN ADI / PRODUCT NAME           | KOD / CODE |  | ↑<br>[MM]   | € |
|-----------------------------------|------------|--|-------------|---|
| Basket Rafı - Base For Dishwasher | AIM-60-DWS |  | 610x610x400 | - |



# BARDAK PASKETLERİ VE YÜKSELTİCİLER

## GLASS BASKETS AND EXTENDERS



**NEW  
PRODUCT**

9 BÖLMELİ BARDAK BASKETİ  
9 COMPERTMENT GLASS RACK

| KOD / CODE | (MM)        | RENK / COLOUR | Ø       | € |
|------------|-------------|---------------|---------|---|
| AIM-GR9    | 500x500X100 | Beige / Bej   | Ø 150mm | - |
| AIM-GRE9   | 500x500X40  | Beige / Bej   | Ø 150mm | - |



16 BÖLMELİ BARDAK BASKETİ  
16 COMPERTMENT GLASS RACK

| KOD / CODE | (MM)        | RENK / COLOUR | Ø       | € |
|------------|-------------|---------------|---------|---|
| AIM-GR16   | 500x500X100 | Grey / Gri    | Ø 113mm | - |
| AIM-GRE16  | 500x500X40  | Grey / Gri    | Ø 113mm | - |



25 BÖLMELİ BARDAK BASKETİ  
25 COMPERTMENT GLASS RACK

| KOD / CODE | (MM)        | RENK / COLOUR | Ø      | € |
|------------|-------------|---------------|--------|---|
| AIM-GR25   | 500x500X100 | Blue / Mavi   | Ø 90mm | - |
| AIM-GRE25  | 500x500X40  | Blue / Mavi   | Ø 90mm | - |

# BARDAK PASKETLERİ VE YÜKSELTİCİLER

## GLASS BASKETS AND EXTENDERS



**NEW  
PRODUCT**

36 BÖLMELİ BARDAK BASKETİ  
36 COMPERTMENT GLASS RACK

| KOD / CODE | (MM)        | RENK / COLOUR | Ø      | € |
|------------|-------------|---------------|--------|---|
| AIM-GR36   | 500x500X100 | Green / Yeşil | Ø 74mm | - |
| AIM-GRE36  | 500x500X40  | Green / Yeşil | Ø 74mm | - |



49 BÖLMELİ BARDAK BASKETİ  
49 COMPERTMENT GLASS RACK

| KOD / CODE | (MM)        | RENK / COLOUR | Ø      | € |
|------------|-------------|---------------|--------|---|
| AIM-GR49   | 500x500X100 | Red / Kırmızı | Ø 63mm | - |
| AIM-GRE49  | 500x500X40  | Red / Kırmızı | Ø 63mm | - |



### YÜKSELTİCİ HESAPLAMA KILAVUZU EXTENDERS CALCULATION GUIDE

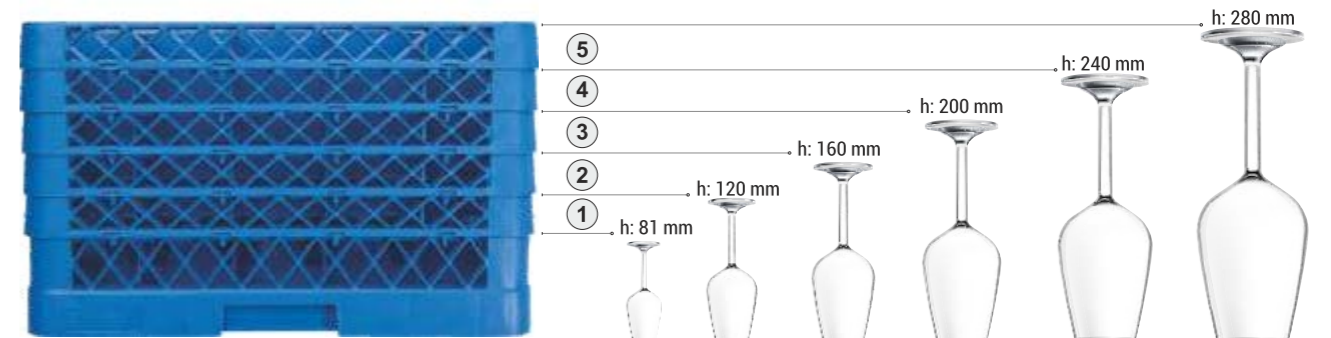



| ÜRÜN ADI / PRODUCT NAME     | KOD / CODE | [MM]    | € |
|-----------------------------|------------|---------|---|
| Tabak Sepeti / Plate Basket | AIM-5050PT | 500x500 | - |

| ÜRÜN ADI / PRODUCT NAME             | KOD / CODE | [MM]    | € |
|-------------------------------------|------------|---------|---|
| Çatal Kaşık Sepeti / Cutlery Basket | AIM-5050CT | 500x500 | - |



| ÜRÜN ADI / PRODUCT NAME      | KOD / CODE | [MM]    | € |
|------------------------------|------------|---------|---|
| Bardak Sepeti / Glass Basket | AIM-5050GS | 500x500 | - |

| ÜRÜN ADI / PRODUCT NAME      | KOD / CODE | [MM]    | € |
|------------------------------|------------|---------|---|
| Bardak Sepeti / Glass Basket | AIM-4040GS | 400x400 | - |



| ÜRÜN ADI / PRODUCT NAME                                 | KOD / CODE | [MM]        | € |
|---|------------|-------------|---|
| Basket Taşıma Arabaları / Basket Trolleys               | AIM-BTP01  | 580x580x220 | - |
| Kulplu Basket Taşıma Arabaları / Handle Basket Trolleys | AIM-BTP02  | 580x580x220 | - |



| ÜRÜN ADI / PRODUCT NAME   | KOD / CODE | [MM]        | € |
|---|------------|-------------|---|
| Paslanmaz Çelik Basket Taşıma Arabaları / Stainless Steel Basket Trolleys | AIM-BTS01  | 550x550x100 | - |
| Kulplu Basket Taşıma Arabaları / Stainless Steel Handle Basket Trolleys   | AIM-BTS02  | 550x550x900 | - |

# ÖN YIKAMA DUŞ SETLERİ

## PRE-RINSE SETS

### TEZGAHA MONTE

#### COUNTER MOUNTED

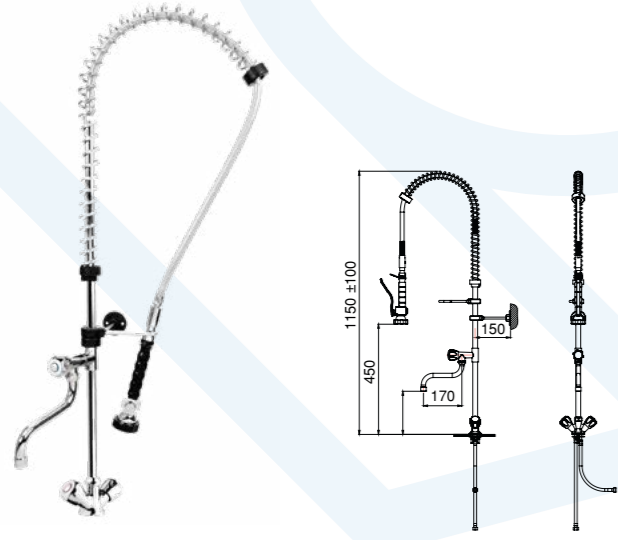

| ÜRÜN ADI / PRODUCT NAME  | KOD / CODE   | € |
|--|--------------|---|
| Ön Yıkama Duş Ünitesi-Ara Musluklu / Pre-Rinse Faucet W/Internal Tap | AIM-CTPR02-E | - |

### DUVARA MONTE

#### WALL MOUNTED

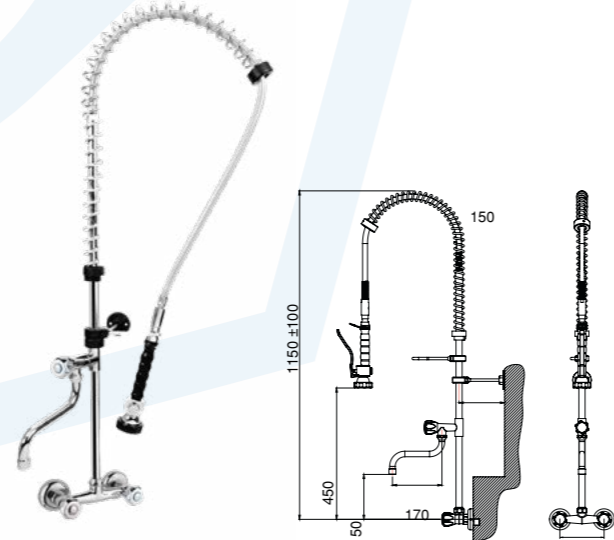

| ÜRÜN ADI / PRODUCT NAME                  | KOD / CODE  | € |
|--|-------------|---|
| Ön Yıkama Duş Ünitesi / Pre-Rinse Faucet | AIM-WPR02-E | - |

### BAR TİPİ TEZGAHA MONTE

#### BAR TYPE COUNTER MOUNTED

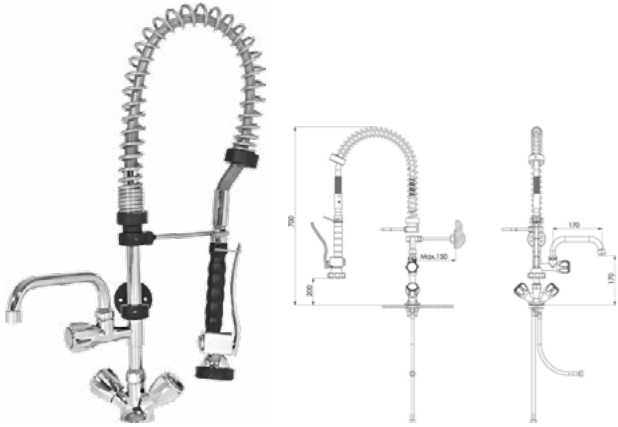

| ÜRÜN ADI / PRODUCT NAME  | KOD / CODE | € |
|--|------------|---|
| Ön Yıkama Duş Ünitesi-Ara Musluklu / Pre-Rinse Faucet W/Internal Tap | AIM-BTPR02 | - |

### GERİ TOPLAMALI YIKAMA HORTUMU - 12MT

#### HOSE REEL - 12MT



| ÜRÜN ADI / PRODUCT NAME                   | KOD / CODE | (M) | € |
|---|------------|-----|---|
| Geri Toplamalı Yıkama Hortumu / Hose Reel | AIM-12HR   | 12  | - |

# ÖN YIKAMA DUŞ SETLERİ

## PRE-RINSE SETS

### TEZGAHA MONTE

#### COUNTER MOUNTED



| ÜRÜN ADI / PRODUCT NAME       | KOD / CODE | (MM)    | € |
|-------------------------------|------------|---------|---|
| Duşlama Ünitesi / Washer Unit | AIM-4023-D | 400x230 | - |



| ÜRÜN ADI / PRODUCT NAME       | KOD / CODE | (MM)    | € |
|-------------------------------|------------|---------|---|
| Duşlama Ünitesi / Washer Unit | AIM-2023-D | 200x230 | - |



| ÜRÜN ADI / PRODUCT NAME            | KOD / CODE | (MM) | € |
|------------------------------------|------------|------|---|
| Blender Durulama / Blender Rinsing | AIM-B01    | 300  | - |

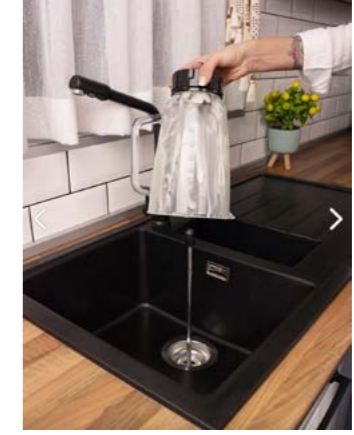

| ÜRÜN ADI / PRODUCT NAME       | KOD / CODE | (MM) | € |
|-------------------------------|------------|------|---|
| Duşlama Ünitesi / Washer Unit | AIM-G02    | Ø100 | - |

**BÜTÜN TESİSAT GRUBU FİYATA DAHİLDİR.**

ALL WATER CONNECTION GROUP IS INCLUDED IN THE PRICE.



FAST FOOD  
EKİPMANLARI



FAST FOOD  
EQUIPMENT



# WAFFLE MAKİNELERİ - KARE

## WAFFLE MAKERS - SQUARE



# WAFFLE MAKİNELERİ - YUVARLAK

## WAFFLE MAKERS - ROUND



### TEKNİK DETAYLAR / TECHNICAL DETAILS

TR

- Mekanik zamanlayıcı seçeneği
- Kolay değiştirilebilir teflon pişirme kalıpları
- Paslanmaz çelik gömülü ısıtıcılar ile hassas sıcaklık kontrolü
- Farklı sıcaklık ayarında çalıştırma
- Seri pişirmelerde yüksek performans
- Gösterge ve sinyal lambaları
- Paslanmaz çelik alt gövde
- Gıda ile temasa uygun pişirme kalıpları ve gövde
- **Teflon kaplı yapışmaz pişirme yüzeyi ve üst gövde**
- Farklı şekillerde değiştirilebilir pişirme kalıpları

EN

- Mechanic timer model options
- Different shaped baking plates feature
- Stainless steel embedded heating element for precise temperature control
- Operation with desired heating temperature
- High performance during dynamic operation
- Power ON and Ready-to-Bake LED indicators
- Stainless steel frame body
- Baking plates and body suitable for food contact
- **Teflon coated Non-Stick baking plate and top body**
- Easy to change teflon coated baking plates

| KOD / CODE | (MM)        | (KW)           | (kg) | (KW) | € |
|------------|-------------|----------------|------|------|---|
| AIM WFL21S | 270x450x270 | 230V - 50-60Hz | 13   | 2,5  | - |
| AIM WFL22S | 270x450x270 | 230V - 50-60Hz | 13   | 2,5  | - |
| AIM WFL23S | 270x450x270 | 230V - 50-60Hz | 13   | 2,5  | - |
| AIM WFL24S | 270x450x270 | 230V - 50-60Hz | 13   | 2,5  | - |
| AIM WFL25S | 270x450x270 | 230V - 50-60Hz | 13   | 2,5  | - |
| AIM WFL26S | 270x450x270 | 230V - 50-60Hz | 13   | 2,5  | - |

### TEKNİK DETAYLAR / TECHNICAL DETAILS

TR

- Mekanik zamanlayıcı seçeneği
- Kolay değiştirilebilir teflon pişirme kalıpları
- Paslanmaz çelik gömülü ısıtıcılar ile hassas sıcaklık kontrolü
- Farklı sıcaklık ayarında çalıştırma
- Seri pişirmelerde yüksek performans
- Gösterge ve sinyal lambaları
- Paslanmaz çelik alt gövde
- Gıda ile temasa uygun pişirme kalıpları ve gövde
- **Teflon kaplı yapışmaz pişirme yüzeyi ve üst gövde**
- Farklı şekillerde değiştirilebilir pişirme kalıpları

EN

- Mechanic timer model options
- Different shaped baking plates feature
- Stainless steel embedded heating element for precise temperature control
- Operation with desired heating temperature
- High performance during dynamic operation
- Power ON and Ready-to-Bake LED indicators
- Stainless steel frame body
- Baking plates and body suitable for food contact
- **Teflon coated Non-Stick baking plate and top body**
- Easy to change teflon coated baking plates

| KOD / CODE | (MM)        | (KW)           | (kg) | (KW) | € |
|------------|-------------|----------------|------|------|---|
| AIM WFL21R | 225x450x250 | 230V - 50-60Hz | 7    | 1,3  | - |
| AIM WFL22R | 225x450x250 | 230V - 50-60Hz | 7    | 1,3  | - |



KRP21



KRP22



PNK21



PNK22



## TEKNİK DETAYLAR / TECHNICAL DETAILS

## TR

- Teflon ve pişirme yüzeyi
- Farklı şekillerde pişirme kalıpları
- Paslanmaz çelik gömülü ısıtıcılar ile hassas sıcaklık kontrolü
- Farklı sıcaklık ayarında çalıştırma
- Seri pişirmelerde yüksek performans
- Gösterge ve sinyal lambası
- Paslanmaz çelik gövde
- Gıda ile temasa uygun pişirme kalıpları ve gövde

## EN

- Teflon coated non stick baking plate
- Different shaped baking plates feature
- Stainless steel embedded heating element for precise temperature control
- Operation with desired heating temperature
- High performance during dynamic operation
- Power ON and Ready-to-Bake LED indicator
- Stainless steel body
- Baking plates and body suitable for food contact

| KOD / CODE | [MM]        | KAPASİTE / CAPACITY | 230V - 50-60Hz | kg | (KW) | € |
|------------|-------------|---------------------|----------------|----|------|---|
| AIM KRP21  | 405x400x180 | 1xØ400              | 230V - 50-60Hz | 15 | 2,5  | - |
| AIM KRP22  | 405x400x180 | 7xØ95               | 230V - 50-60Hz | 15 | 2,5  | - |
| AIM PNK21  | 405x400x180 | 14xØ78              | 230V - 50-60Hz | 15 | 2,5  | - |
| AIM PNK22  | 405x400x180 | 37xØ40              | 230V - 50-60Hz | 15 | 2,5  | - |

CLM01

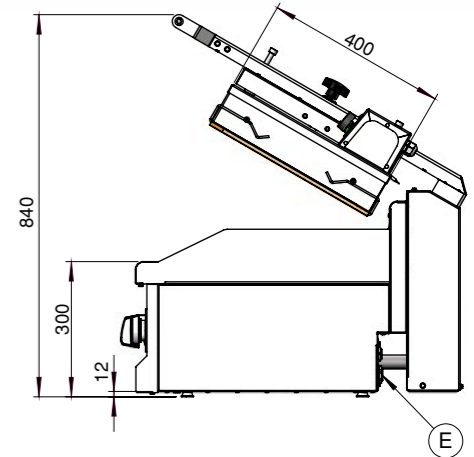

## TEKNİK DETAYLAR / TECHNICAL DETAILS

## TR

- Çelik alt ve üst plakalar
- Yapışmaz ızgara yüzeyi için teflon film kaplı üst plaka
- Üst ve alt plaka için ayrı termostatik kontrol
- Üst plaka için maksimum 250 °C, alt plaka için maksimum 300 °C çalışma sıcaklığı
- Üst plaka kapatıldığında ızgara olarak çalıştırılabilir

## EN

- Steel lower and upper plates
- Teflon film coated upper plate for nonstick grill surface
- Separate thermostatic control for upper and lower plate
- For upper plate max 250 °C for lower plate 300 °C max operating temperature
- Can be operated as grill when upper plate is turned off

| KOD / CODE | [MM]        | 400V - 50-60Hz | kg | (KW) | € |
|------------|-------------|----------------|----|------|---|
| AIM CLM01  | 810x400x500 | 400V - 50-60Hz | 64 | 6,2  | - |

NEW  
PRODUCT

HCH01



## TEKNİK DETAYLAR / TECHNICAL DETAILS

TR

- Cihazın pişirici tel bantta hız kontrolü yapılmaktadır. Cihaz içerisinden minimum ürün geçirme hızı 45 sn ve maksimum 255 sn arasında ayarlanabilir.
- Paslanmaz çelik yapıyla dayanıklı, hijyenik ve kolay temizlenir.
- Ergonomik tasarımı ve ayarlanabilir ayakları kullanıcıya kolaylık sağlar.
- Çıkarılabilir kırıntı tepsi ve hız kontrol özellikli pişirici tel bant mevcuttur.
- Enerji verimli kuvars rezistanslar ve fanlı soğutma sistemi bulunur.
- Alt-üst ısı kontrolü yapılabilir, rulmanlar yağlama gerektirmez.
- Elektrik bağlantısı için sigorta değeri uzman elektrikçi tarafından belirlenmelidir.

EN

- The cooking wire belt of the device features speed control, with a minimum product passing time of 45 seconds and a maximum of 255 seconds.
- Durable, hygienic, and easy to clean with its stainless steel construction.
- Ergonomic design and adjustable feet provide ease of use.
- Removable crumb tray and speed-controlled cooking wire belt are available.
- Energy-efficient quartz resistors and a fan cooling system are included.
- Real-time adjustable top and bottom heat control; bearings do not require lubrication.
- Fuse rating for electrical connection should be determined by a qualified electrician based on cable length.

| KOD / CODE | (MM)        | (V)       | (kg) | (KW) | €     |
|------------|-------------|-----------|------|------|-------|
| AIM HCH01  | 670x490x485 | 220-240 V | 32   | 3,6  | 1.365 |

BUN01



BUN02



BTW

BUTTER  
WHEELER

| KOD / CODE | (MM)        | €   |
|------------|-------------|-----|
| AIM BTW    | 180x160x130 | 125 |

## TEKNİK DETAYLAR / TECHNICAL DETAILS

TR

- Paslanmaz çelik gövde
- 10-50 mm aralığında ayarlanabilir mesafe
- 100 °C - 350 °C arası ayarlanabilir çalışma sıcaklığı
- BUN01 modeli için; 18-60 saniye konveyör hızı
- BUN02 modeli için; 22 saniye konveyör hızı
- Ergonomik tasarım ve kolay temizleme imkanı.

EN

- Stainless steel body
- 10-50 mm adjustable distance
- 100 °C - 350 °C temperature range
- 18-60 seconds conveyor speed for BUN01 model
- 22 seconds constant conveyor speed for BUN02 model
- Ergonomic design providing convenience to users in all aspects.

| KOD / CODE | (MM)        | (V)       | (kg) | (KW) | €     |
|------------|-------------|-----------|------|------|-------|
| AIM BUN01  | 700x235x720 | 220-240 V | 42   | 2    | 3.505 |
| AIM BUN02  | 650x235x730 | 380-410 V | 38   | 2    | 2.490 |

## BAR BLENDİRLARI SESSİZ

### BAR BLENDERS SILENT

## BAR BLENDİRLARI

### BAR BLENDERS

BLE3-RS



BLE3-BLS



BLE3-BS



BLE3-R



BLE3-B



BLE2-R



BLE2-B



BUZ KIRMA ÖZELLİĞİ  
ICE CRUSHER FEATURE



### TEKNİK DETAYLAR / TECHNICAL DETAILS

TR

- Manuel ve otomatik model seçeneği
- Karıştırma ve parçalama özelliği
- Max 25.000 RPM çalışma hızı
- Sessiz Çalışma özelliği
- 2 lt sürahi kapasitesi
- Hız kontrolü
- Buz kırma özelliği
- ABS gövde
- Gıda ile temasa uygun Polikarbon sürahi

EN

- Manual and digital model option
- Mix and pulse option
- Max. 25.000 RPM working speed
- Quiet operation feature
- 2 lt jug capacity
- Speed control
- Ice crushing feature
- ABS Body
- Polycarbonate container suitable for food contact

| KOD / CODE   | [MM]        | lt | [KW]           | kg | [KW] | € |
|--------------|-------------|----|----------------|----|------|---|
| AIM BLE3-RS  | 245x260x470 | 2  | 230V - 50/60Hz | 7  | 2,2  | - |
| AIM BLE3-BLS | 245x260x470 | 2  | 230V - 50/60Hz | 7  | 2,2  | - |
| AIM BLE3-BS  | 245x260x470 | 2  | 230V - 50/60Hz | 7  | 2,2  | - |

### TEKNİK DETAYLAR / TECHNICAL DETAILS

TR

- Manuel ve dijital model seçeneği
- Karıştırma ve parçalama özelliği
- Max 25.000 RPM çalışma hızı
- Kapak sensörlü
- 3 veya 2 lt sürahi kapasitesi
- Hız kontrolü
- Buz kırma özelliği
- ABS gövde
- Gıda ile temasa uygun polikarbon sürahi

EN

- Manual and digital model option
- Mix and pulse option
- Max. 25.000 RPM working speed
- Lid sensor
- 3 or 2 lt jug capacity
- Speed control
- Ice crushing feature
- ABS Body
- Polycarbonate container suitable for food contact

| KOD / CODE | [MM]        | lt | [KW]        | kg  | [KW] | € |
|------------|-------------|----|-------------|-----|------|---|
| AIM BLE3-R | 210x240x490 | 3  | 230V - 50Hz | 4,7 | 2,2  | - |
| AIM BLE3-B | 210x240x490 | 3  | 230V - 50Hz | 4,7 | 2,2  | - |
| AIM BLE2-R | 210x240x430 | 2  | 230V - 50Hz | 4,5 | 2,2  | - |
| AIM BLE2-B | 210x240x430 | 2  | 230V - 50Hz | 4,5 | 2,2  | - |

# TÜRK KAHVESİ MAKİNESİ TURKISH COFFEE MACHINE

ATKM-2M



ATKM-4M



ATKM-3M



# ÇAY MAKİNESİ TEA BOILER

NEW  
PRODUCT

TBS02



TBW02



## TEKNİK DETAYLAR / TECHNICAL DETAILS

TR

- Paslanmaz çelik konstrüksiyonu ile uzun ömürlü, kolay temizlenebilir ve hijyeniktir.
- Kullanıcıya her yönden kolaylık sağlayan ergonomik dizayna sahiptir.
- Cihazda patentli köpük algılama, ısı algılama, karıştırma ve cezveye su ilavesi ile görevli ekipmanların yukarı aşağı yönde hareket etmesini sağlayan asansör sistemi bulunmaktadır.
- Cezveyi alttan ve yukarıdan sıkıştırma yöntemi ile ısı kaybı minimum seviyede tutulur.
- Kahvenin köpüğünü ve kabarmasını algılayan iyon sensörü bulunmaktadır.
- Kahvenin dibe çökmesini engelleyen kahve çubuğu pişirme esnasında homojen bir karışım elde edilmesini sağlar.
- Cihazda pişirme, yıkama ve depo su seviyesi için hem led sinyal lambaları hemde sesli uyarı sistemi bulunmaktadır.
- Cihaz üzerinde cezve pozisyonunu belirleyici swich bulunmaktadır. Böylece cezve yerine oturmadan pişirme işlemi başlatılamaz.
- Cihazın deposuna su dolumu su pompası ile otomatik olarak yapılır.

EN

- Stainless steel sheet construction provides hygiene long service life and easy of cleaning
- Ergonomic design providing convenience to users in all aspects
- The device has a patented foam detection, heat detection, mixing and elevator system that allows the equipment in charge of adding water to the coffee pot to move up and down.
- Heat loss is kept to a minimum with the method of compressing the coffee pot from above and below.
- There is an ion sensor that detects the foam of the coffee.
- A homogeneous mixture is obtained at the end of the coffee making, which prevents the coffee from sinking to the bottom.
- The Device is equipped with warning system on screen and voice warning system, for water level and cleaning system.
- There is a switch that determines the coffee pot position on the device, so cooking cannot be done without the coffee pot is not in the right position.

| KOD / CODE  | (MM)        | lt |           | kg | (KW) | PORSİYON / PORTIONS | € |
|-------------|-------------|----|-----------|----|------|---------------------|---|
| AIM ATKM-2M | 370x400x385 | 2  | 220-240 V | 15 | 1,32 | 2x2                 | - |
| AIM ATKM-3M | 500x400x385 | 3  | 220-240 V | 25 | 1,93 | 3x2                 | - |
| AIM ATKM-4M | 630x400x385 | 3  | 220-240 V | 30 | 2,54 | 4x2                 | - |

## TEKNİK DETAYLAR / TECHNICAL DETAILS

TR

- Kullanıcı dostu yüksek çözünürlüklü ekran.
- Enerji tasarrufu için yalıtılmış su deposu.
- Eko modu, güç tasarrufu modu.
- AISI 316 Paslanmaz Çelik Yalıtımlı Su Deposu.
- AISI 304 Paslanmaz çelik gövde.
- Sıcak su vanası.
- Ayarlanabilir sıcaklık kontrolü.
- Gerçek zamanlı sıcaklık göstergesi.
- Zamanlayıcı modu: belirli bir süre sıcak su vermeye hazır.
- Çıkarılabilir damla toplama tepsi.
- Su bağlantısı.
- Kapasite: 30L/saat.

EN

- User friendly high definition display.
- Isolated water tank for Energy saving.
- Eco mode, energy saving mode.
- AISI 316 stainless steel isolated water tank.
- AISI 304 stainless steel body.
- Hot water valve.
- Adjustable temperature control.
- Live temperature readout.
- Timer mode: ready to serve hot water for a certain time.
- Removable drip tray.
- Water connection.
- Capacity 30 lt/hour.

| KOD / CODE | (MM)        | lt |            | kg | (KW) | € |
|------------|-------------|----|------------|----|------|---|
| AIM TBS02  | 250x590x450 | 8  | 230 V - 1N | 8  | 3    | - |
| AIM TBW02  | 250x590x450 | 8  | 230 V - 1N | 8  | 3    | - |



ET-HH



ET-SH

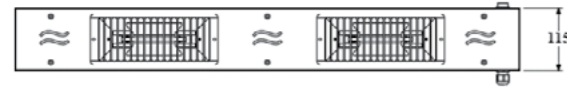
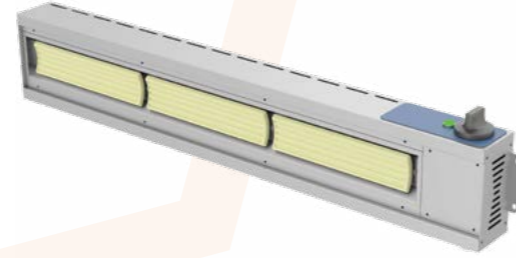

HALOGEN

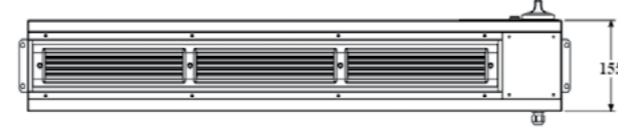

CERAMIC

## TEKNİK DETAYLAR / TECHNICAL DETAILS

TR

- Paslanmaz Çelik AISI 430'dan üretilmiştir
- Halojen veya seramik ısıtma elemanı
- Mükemmel ısı dağılımı
- Kolay kurulum
- Açma kapama anahtarı 230V
- ET modelleri ile kullanılabilir

EN

- Made of brushed stainless steel AISI 430
- Halogeneen or ceramic warming element
- Excellent heat distribution
- Handy installation
- On off switch 230V
- Usable with the ET models

| KOD CODE  |           | <br>(MM) | €  |    |
|-----------|-----------|----------|----|----|
| HH        | SH        |          | HH | SH |
| ET-100-HH | ET-100-SH | 1000x300 | -  | -  |
| ET-120-HH | ET-120-SH | 1200x300 | -  | -  |
| ET-140-HH | ET-140-SH | 1400x300 | -  | -  |
| ET-160-HH | ET-160-SH | 1600x300 | -  | -  |
| ET-180-HH | ET-180-SH | 1800x300 | -  | -  |
| ET-200-HH | ET-200-SH | 2000x300 | -  | -  |

## TEKNİK DETAYLAR / TECHNICAL DETAILS

TR

- Tavana montaj.
- Açma/Kapama anahtarı.
- Lambaların üst kısmındaki delikler aşırı ısınmayı önler.
- Profesyonel gıda hizmeti işletmelerinde kullanım için idealdir.
- Ergonomik olarak mükemmel tasarlanmış.
- Şık ve işlevsel.
- Kolay temizlenir.
- **Halojenik ampul fiyata dahildir.**

EN

- Ceiling mounting
- On / off switch
- The perforation on the lamps' upper section prevents an overheating
- Ideal for use in professional food service establishments
- Ergonomically perfectly formed
- Stylish & functional
- Easy to clean
- **Halogenic Lamp is included in the price**

| KOD / CODE | <br>(MM)    | € |
|------------|-------------|---|
| AIM IWL-B  | ø 260 x 220 | - |
| AIM IWL-S  | ø 260 x 220 | - |
| AIM IWL-C  | ø 260 x 220 | - |

IWL-B

NEW  
PRODUCT

IWL-S



IWL-C



PG03



PG02



PG01



ESL4







## TEKNİK DETAYLAR / TECHNICAL DETAILS

## TR

- Üst ve alt nervürlü ızgara plakası
- 50 °C - 300 °C arası ayarlanabilir çalışma sıcaklığı
- Isıya dayanıklı bakalit kulp
- Ayarlanabilir termostat

## EN

- Grill plate ribbed at the top & bottom
- 50 °C - 300 °C temperature range
- Heat resistant handle
- Adjustable thermostat

| KOD / CODE |  [MM] |  |  kg |  [KW] | € |
|------------|--|---|--|--|---|
| AIM PG01   | 410x500x300  | 220-240 V   | 29   | 2,5  | - |
| AIM PG02   | -x500x300  | 220-240 V   | 33   | 3  | - |
| AIM PG03   | 500x440x300  | 220-240 V   | 34   | 3,5  | - |





## TEKNİK DETAYLAR / TECHNICAL DETAILS

## TR

- Termostatik kontrol.
- Yüksekliği ayarlanabilir su ve yağ çekmecesi.
- Paslanmaz çelik gövde.
- Hijyenik kullanım için pislik tavası.

## EN

- Thermostatic control.
- Height-adjustable collection tray for grease and water
- High-quality construction
- Made from stainless steel

| KOD / CODE |  [MM] |  |  kg |  [KW] | € |
|------------|--|---|--|--|---|
| AIM ESL2   | 450X500X540  | 220-240 V   | 35   | 2,8  | - |
| AIM ESL4   | 600X500X540  | 220-240 V   | 47   | 3  | - |

GSL6

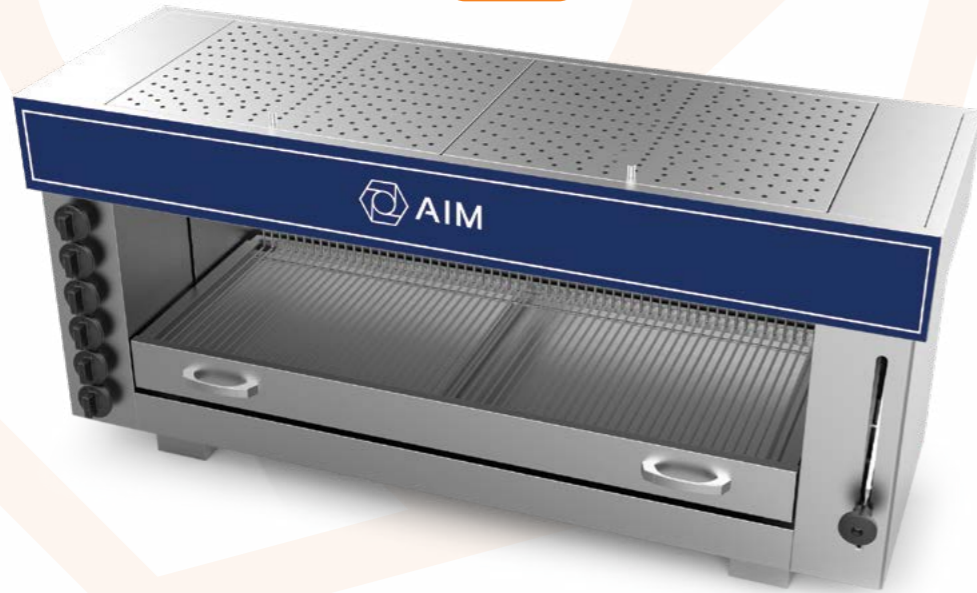

GSL2



GSL4



## TEKNİK DETAYLAR / TECHNICAL DETAILS

## TR

- Seramik brülörler.
- Yüksekliği ayarlanabilir su ve yağ çekmecesi.
- Paslanmaz çelik gövde.
- Hijyenik kullanım için pislik tavası.

## EN

- Ceramic burner
- Standard version on natural gas
- Height-adjustable collection tray for grease and water
- High-quality construction
- Made from stainless steel

| KOD / CODE | (MM)         | BURNER | kg | (KW) | € |
|------------|--------------|--------|----|------|---|
| AIM GSL2   | 650x430x600  | 2      | 38 | 5,4  | - |
| AIM GSL4   | 960x430x600  | 4      | 55 | 10,8 | - |
| AIM GSL6   | 1290x430x600 | 6      | 75 | 16,2 | - |

IND35



IND50



IND100



IND70



INDGN



## TEKNİK DETAYLAR / TECHNICAL DETAILS

## TR

- Seramik cam pişirme yüzeyi
- Tekli ve çiftli model seçeneği
- Çok kısa sürede pişirme imkânı ile enerji tasarrufu
- Dijital kontrol paneli ile kullanım kolaylığı
- Elektronik zaman ayarı
- Farklı sıcaklık ayarında çalıştırma
- Seri pişirmelerde yüksek performans
- Paslanmaz çelik gövde

## EN

- Vitro -ceramic glass cooking surface
- Single and double model options
- Energy saving with the possibility of cooking in a very short time
- Easy operation with digital control panel
- Electronic timer
- Operation with desired heating temperature
- High performance during dynamic operation
- Stainless steel body

| KOD / CODE | (MM)        | (KW)         | kg | (KW)  | € |
|------------|-------------|--------------|----|-------|---|
| AIM IND35  | 500x400x130 | 230V 50-60Hz | 8  | 3,5   | - |
| AIM IND50  | 500x400x130 | 230V 50-60Hz | 8  | 5     | - |
| AIM IND70  | 800x495x130 | 230V 50-60Hz | 15 | 2x3,5 | - |
| AIM IND100 | 800x495x130 | 230V 50-60Hz | 15 | 2x5   | - |
| AIM INDGN  | 700x620x170 | 230V 50-60Hz | 20 | 2x3,5 | - |



### TEKNİK DETAYLAR / TECHNICAL DETAILS

#### TR

- LPGli ve NG seçenekleri mevcuttur.
- Emniyet ventili kontrol dışı sönen radyanlara giden gazı otomatik olarak keser.
- Üstten motorlu çift yöne döndürebilme özelliğine sahiptir.
- Döner ocağı kanatları mevcut değildir, opsiyonel olarak takılabilir.
- Üstten motorlu döner ocaklarında, motorun arıza yapması durumunda döner ocağı manuel olarak kullanılabilir.
- Üstten motorlu döner ocaklarında, alev perdesi motorla beraber hareket ettiği için motorun ömrünü uzatır.
- Paslanmaz et toplama tepsi.
- Hareketli şiş tutucu sayesinde eti yakınlaştırma ve uzaklaştırma imkanı.
- Delikli tepsi sayesinde yağ süzme imkanı.

#### EN

- LPG and NG options available.
- Safety valve automatically cuts off the gas from the radiant heaters that go out unexpectedly.
- Electric motor installed at the top rotates in both directions.
- Side flaps are available as an option.
- In case of failure of the electric motor, the machine can be controlled manually.
- Flame curtain moving along with the motor extends the life of the motor.
- Stainless steel meat tray.
- Movable skewer holder maintain forward and backward moving.
- Holed tray helps easy fat dripping.

| KOD / CODE | (MM)         | BURNER | kg | (KW) | € |
|------------|--------------|--------|----|------|---|
| AIM DMT3   | 630x825x975  | 3      | 30 | 10,2 | - |
| AIM DMT4   | 630x825x1140 | 4      | 35 | 13,6 | - |
| AIM DMT5   | 630x825x1310 | 5      | 38 | 17   | - |

### TEKNİK DETAYLAR / TECHNICAL DETAILS

#### TR

- LPGli ve NG seçenekleri mevcuttur.
- Emniyet ventili kontrol dışı sönen radyanlara giden gazı otomatik olarak keser.
- Üstten motorlu çift yöne döndürebilme özelliğine sahiptir.
- Döner ocağı kanatları mevcut değildir, opsiyonel olarak takılabilir.
- Üstten motorlu döner ocaklarında, motorun arıza yapması durumunda döner ocağı manuel olarak kullanılabilir.
- Üstten motorlu döner ocaklarında, alev perdesi motorla beraber hareket ettiği için motorun ömrünü uzatır.
- Paslanmaz et toplama tepsi.
- Hareketli şiş tutucu sayesinde eti yakınlaştırma ve uzaklaştırma imkanı.
- Delikli tepsi sayesinde yağ süzme imkanı.

#### EN

- LPG and NG options available.
- The motor can be controlled on the device itself.
- The body can be moved back and forth to adjust the distance to the meat.
- Dripping fat from the meat can be easily drained to the discharge drawer from the inclined tray for easy removal.
- Safety valve automatically cuts off the gas from the radiant heaters that go out unexpectedly.
- Use of manual motor in case of power outages.
- Electric motor installed at the bottom rotates in both directions.
- Tray and side flaps are available as an option.

| KOD / CODE | (MM)         | BURNER | kg | (KW) | € |
|------------|--------------|--------|----|------|---|
| AIM DMB3   | 575x715x960  | 3      | 38 | 10,2 | - |
| AIM DMB4   | 575x715x1135 | 4      | 43 | 13,6 | - |
| AIM DMB5   | 575x715x1300 | 5      | 48 | 17   | - |

## ELEKTRİKLİ DÖNER OCAKLARI - ÜSTTEN MOTOR ELECTRICAL DONER MACHINES - TOP MOTOR

NEW  
PRODUCT



### TEKNİK DETAYLAR / TECHNICAL DETAILS

TR

- LPG ve NG seçenekleri mevcuttur.
- Güvenlik valfi, aniden sönen radyant ısıtıcılardan gazı otomatik olarak keser.
- Yan kanatlar opsiyonel olarak mevcuttur.
- Paslanmaz çelik et tepsisi.
- Hareketli şiş tutucu, ileri ve geri hareket etmeyi sağlar.

EN

- LPG and NG options available.
- Safety valve automatically cuts off the gas from the radiant heaters that go out unexpectedly.
- Side flaps are available as an option.
- Stainless Steel meat tray.
- Movable skewer holder malntaln forward and backward moving.

| KOD / CODE | (MM)         | BURNER | kg | (KW) | € |
|------------|--------------|--------|----|------|---|
| AIM EDMT3  | 630x825x975  | 3      | 28 | 4,8  | - |
| AIM EDMT4  | 630x825x1140 | 4      | 33 | 6,4  | - |
| AIM EDMT5  | 630x825x1310 | 5      | 38 | 8    | - |

## ELEKTRİKLİ DÖNER OCAKLARI - ALTTAN MOTOR ELECTRICAL DONER MACHINES - BOTTOM MOTOR

NEW  
PRODUCT



### TEKNİK DETAYLAR / TECHNICAL DETAILS

TR

- Elektrik kontrollü ve seran camlıdır.
- Seran camlı olması sayesinde kullanım sonrası biriken atıklar kolayca temizlenebilmektedir.
- Döner ocağının motoru cihaz üzerinden kontrol edilebilir.
- Cihaz gövdesi hareketli olup döner etine istenilen ölçüde yakınlştırılabilir. Böylece yakıt tasarrufu sağlanmaktadır.
- Alt gövdeye dökülen yağlar, tepsinin eğimli olması sayesinde yağ tahliye çekmecesini ile tahliye edilir.
- Alttan motorlu çift yöne döndürebilme özelliğine sahiptir.
- Döner ocağı tepsisi ve kanatları mevcut değildir, opsiyonel olarak takılabilir.

EN

- Electric controlled and complete with Ceran Glass.
- Ceran Glass surface enables easy cleaning after use.
- The motor can be controlled on the device itself.
- The body can be moved back and forth to adjust the distance to the meat.
- Dripping fat from the meat can be easily drained to the discharge drawer from the inclined tray for easy removal.
- Electric motor installed at the bottom rotates in both sides.
- Tray and side flaps are available as an option.
- Burners are adjustable with two modes such as. (min-max)

| KOD / CODE | (MM)         | BURNER | kg | (KW) | € |
|------------|--------------|--------|----|------|---|
| AIM EDMB3  | 565x715x960  | 3      | 48 | 4,8  | - |
| AIM EDMB4  | 565x715x1135 | 4      | 55 | 6,4  | - |
| AIM EDMB5  | 565x715x1300 | 5      | 65 | 8    | - |

## EL BLENDER - 30 CM

### IMMERSION BLENDERS - 30 CM



## EL BLENDER - 40 CM

### IMMERSION BLENDERS - 40 CM



#### TEKNİK DETAYLAR / TECHNICAL DETAILS

##### TR

- Sabit hız ve paslanmaz çelik bıçak
- Parçalayıcı (300 mm)
- Çırpıcı Aparat (360 mm-Combi modeller için)
- Easy lock sistemi ile kolay kullanım
- Devir hızı: 13000 rpm

##### EN

- Constant speed and stainless steel blade
- Mixer arm 300 mm
- Whisk (360 mm-Combi models only)
- Easy to use with Easy lock system
- Revolution: 13000 rpm

| KOD / CODE | (MM)       |     | kg   | (KW)       | € |
|------------|------------|-----|------|------------|---|
| AIM IB30   | 130x98x595 | 350 | 2,25 | 220 V - 1N | - |
| AIM IB30K  | 130x98x595 | 350 | 3,15 | 220 V - 1N | - |

#### TEKNİK DETAYLAR / TECHNICAL DETAILS

##### TR

- Kademeli hız ayarı ve paslanmaz çelik bıçak
- Parçalayıcı aparat (400 mm)
- Çırpıcı Aparat (360 mm-Combi modeller için)
- Easy lock sistemi ile kolay kullanım
- Devir hızı: 11000 rpm max

##### EN

- Gradual speed adjustment and stainless steel blade
- Mixer arm (400 mm)
- Whisk (360 mm-Combi models only)
- Easy to use with Easy lock system
- Revolution: 11000 rpm max

| KOD / CODE | (MM)        |     | kg   | (KW)       | € |
|------------|-------------|-----|------|------------|---|
| AIM IB40   | 146x120x790 | 650 | 3,90 | 220 V - 1N | - |
| AIM IB40K  | 146x120x790 | 650 | 4,90 | 220 V - 1N | - |

TAŞIMA  
ÜNİTELERİ



CARRYING  
UNITS



 R290 İstenildiği takdirde fiyatlara %3 ilave edilir. / For R290 Refrigerant gas, price increase is 3%.

NEW  
PRODUCT

## TEKNİK DETAYLAR / TECHNICAL DETAILS

## TR

- 0 - 90 °C dijital termostat kontrollüdür.
- Paslanmaz çelikten imal edilmiştir.
- 2 adet frenli, 2 adet frensiz tekerleklidir.
- Pres baskı iç tepsi kızakları.
- Gövde ve kapı çift cidarlı poliüretan izolasyonludur.
- Tabandaki ısıtmalı havuz sayesinde nemlendirme özelliğine sahiptir.
- Isıtıcı kaset halinde çıkarılabilir. Hijyenik ve kolay temizlik imkanı sağlar.
- Çarpmalara karşı 4 tarafı lastik tampon ile çevrilidir.
- **BTH2221, GN 2/1 100 x 22 adet küvet kapasitelidir**
- **BTH1021, GN 2/1 100 x 10 adet küvet kapasitelidir**

## EN

- 0 - 90 °C digital thermostat control.
- Made of stainless steel.
- 4 casters, 2 with brake.
- Pressed inside rails.
- Body and door are double walled and insulated with polyurethane.
- Humidification feature with the heated pool at the bottom.
- Corners equipped with rubber material for protection against impacts.
- Heater can be removed as cartridge. Hygienic and easy cleaning.
- **BTH2221, GN 2/1 100 x 22 pan capacity.**
- **BTH1021, GN 2/1 100 x 10 pan capacity.**

| KOD / CODE  | 🌡️       | 📏<br>(MM)     | 🔌            | ⚖️<br>(kg) | ⚡<br>(kW) | GN<br>2/1-100 | € |
|-------------|----------|---------------|--------------|------------|-----------|---------------|---|
| AIM BTH2221 | 0 / + 90 | 1350x888x1835 | 230V 50-60Hz | 200        | 3         | 11x2          | - |
| AIM BTH1021 | 0 / + 90 | 740x950x1830  | 230V 50-60Hz | 136        | 1,70      | 10            | - |



## TEKNİK DETAYLAR / TECHNICAL DETAILS

## TR

- 0 - 90 °C dijital termostat kontrollüdür.
- Paslanmaz çelikten imal edilmiştir.
- 2 adet frenli, 2 adet frensiz tekerleklidir.
- Pres baskı iç tepsi kızakları.
- Gövde ve kapı çift cidarlı poliüretan izolasyonludur.
- Tabandaki ısıtmalı havuz sayesinde nemlendirme özelliğine sahiptir.
- Su haznesindeki su sıcaklığı ayrı termostat ile kontrol edilir.
- Su boşaltma vanalıdır.
- Çarpmalara karşı 4 tarafı lastik tampon ile çevrilidir.
- **BTH621, GN 2/1 100 x 6 adet küvet kapasitelidir.**
- **BTH1511, GN 1/1 65 x 15 adet küvet kapasitelidir.**

## EN

- 0 - 90 °C digital thermostat control.
- Made of stainless steel.
- 4 casters, 2 with brake.
- Pressed inside rails.
- Body and door are double walled and insulated with polyurethane.
- Humidification feature with the heated pool at the bottom.
- Corners equipped with rubber material for protection against impacts.
- Heater can be removed as cartridge. Hygienic and easy cleaning.
- **BTH621, GN 2/1 100 x 6 pan capacity.**
- **BTH1511, GN 1/1 65 x 15 pan capacity.**

| KOD / CODE  | 🌡️       | 📏<br>(MM)    | 🔌            | ⚖️<br>(kg) | ⚡<br>(kW) | GN<br>CAPACITY | € |
|-------------|----------|--------------|--------------|------------|-----------|----------------|---|
| AIM BTH621  | 0 / + 90 | 840x920x1090 | 230V 50-60Hz | 106        | 1,65      | 6 (2/1-100)    | - |
| AIM BTH1511 | 0 / + 90 | 590x870x1550 | 230V 50-60Hz | 142        | 2,05      | 15 (1/1-100)   | - |

AIM

## AIM BTR / BTF

SOĞUTMALI & DONDURUCULU BANKET ARABALARI  
COOLING & FREEZING BANQUET TROLLEYS

## TEKNİK DETAYLAR / TECHNICAL DETAILS

TR

- Dış ortam sıcaklığı +43°C %65 nem oranı
- Eşit sıcaklık dağılımı için yeni tasarım
- Sıfır ODP enjekte 42 kg/m<sup>3</sup> çevre dostu poliüretan izolasyon
- Kolay okunur ekranlı dijital kontrol
- Ergonomik kapı ve kulpu sayesinde kolay açılma ve temizlik
- Patentli 'Icecool' soğutma sistemi ile mükemmel verim ve enerji sarfiyatı
- Sıcak gaz defrost sistemi
- Atık ısı geri kazanımlı kondanzasyon
- Tüm buzdolapların marine versiyonları mevcuttur.
- 12 Adet 2/1 Gn kapasitesi.

EN

- Designed to operate in 43°C ambient %65 humidity
- New design for equal temperature distribution
- Zero ODP Injected 42 kg/m<sup>3</sup> Polyurethane Insulation
- Digital controller with easy read screen
- Ergonomic door and handle designed for ease of opening and cleaning
- Icecool refrigeration system designed to be most technologically advanced and energy efficient yet
- Hot gas defrost system
- Waste heat recovery condensate vaporiser system
- All refrigerators can be produced in marine version
- 12 No's 2/1 Gn capacity

AIM BTR / BTF

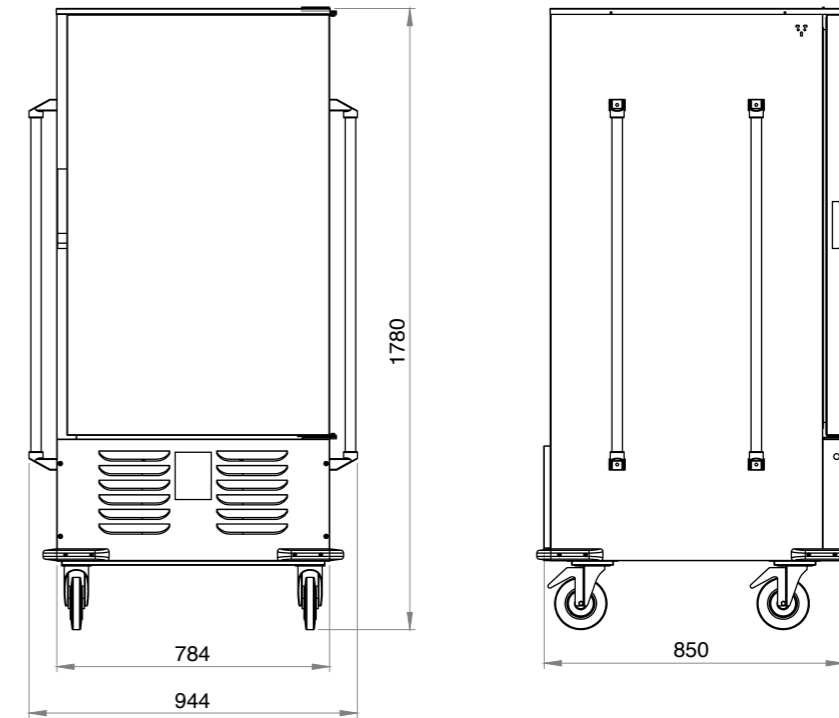

| KOD / CODE | °C          | MM           | lt  | Power       | kg  | (KW) | GN 2/1-60 | PASLANMAZ TİPİ S.S. TYPE | € |
|------------|-------------|--------------|-----|-------------|-----|------|-----------|--------------------------|---|
| AIM BTR3   | - 2 / + 8   | 789x850x1785 | 525 | 230V - 50Hz | 131 | 0,33 | 12        | 304                      | - |
| AIM BTR4   | - 2 / + 8   | 789x850x1785 | 525 | 230V - 50Hz | 131 | 0,33 | 12        | 430                      | - |
| AIM BTF3   | - 18 / - 22 | 789x850x1785 | 525 | 230V - 50Hz | 131 | 0,57 | 12        | 304                      | - |
| AIM BTF4   | - 18 / - 22 | 789x850x1785 | 525 | 230V - 50Hz | 131 | 0,57 | 12        | 430                      | - |

R290 istenildiği takdirde fiyatlara %3 ilave edilir. / For R290 Refrigerant gas, price increase is 3%.

BULAŞIK TOPLAMA ARABASI  
SOILED DISH TROLLEY

| KOD CODE  | <br>[MM] | PASLANMAZ TİPİ<br>S.S. TYPE | € |
|-----------|---|-----------------------------|---|
| AIM SDT03 | 850x550x900   | 304                         | - |

TAHLİYELİ TAŞIMA ARABASI  
TROLLEY WITH DRAIN VALVE

| KOD CODE | <br>[MM] | PASLANMAZ TİPİ<br>S.S. TYPE | € |
|----------|---|-----------------------------|---|
| AIM TDW3 | 550x860x900   | 304                         | - |

SERVİS ARABASI-İKİ KATLI  
SERVICE TROLLEY-2 LAYERS

| KOD CODE  | <br>[MM] | PASLANMAZ TİPİ<br>S.S. TYPE | € |
|-----------|---|-----------------------------|---|
| AIM ST2-3 | 550x860x900   | 304                         | - |
| AIM ST2-4 | 550x860x900   | 430                         | - |

ÇÖP ARABASI  
WASTE BIN

| KOD CODE | <br>[MM] | PASLANMAZ TİPİ<br>S.S. TYPE | € |
|----------|---|-----------------------------|---|
| AIM WB3  | 400400  | 304                         | - |

SERVİS ARABASI-ÜÇ KATLI  
SERVICE TROLLEY-3 LAYERS

| KOD CODE  | <br>[MM] | PASLANMAZ TİPİ<br>S.S. TYPE | € |
|-----------|---|-----------------------------|---|
| AIM ST3-3 | 550x860x900   | 304                         | - |
| AIM ST3-4 | 550x860x900   | 430                         | - |

PLATFORM ARABASI  
PLATFORM TROLLEY

| KOD CODE | <br>[MM] | PASLANMAZ TİPİ<br>S.S. TYPE | € |
|----------|---|-----------------------------|---|
| AIM PT3  | 800x600x200/900   | 304                         | - |

1/1 GN TEPŞİ TAŞIMA ARABASI  
1/1 GN TROLLEY

| KOD CODE  | [MM]         | GN 1/1 KAPASİTESİ<br>GN 1/1 CAPACITY | PASLANMAZ TİPİ<br>S.S. TYPE | € |
|-----------|--------------|--------------------------------------|-----------------------------|---|
| AIM 11-9  | 440x630x900  | 9                                    | 304                         | - |
| AIM 11-17 | 440x630x1720 | 17                                   | 304                         | - |

2/1 GN TEPŞİ TAŞIMA ARABASI  
2/1 GN TROLLEY

| KOD CODE  | [MM]         | GN 2/1 KAPASİTESİ<br>GN 2/1 CAPACITY | PASLANMAZ TİPİ<br>S.S. TYPE | € |
|-----------|--------------|--------------------------------------|-----------------------------|---|
| AIM 21-9  | 580x660x900  | 9                                    | 304                         | - |
| AIM 21-17 | 580x660x1720 | 17                                   | 304                         | - |

15 TEPŞİ KAPASİTELİ  
15 TRAY CAPACITY37x53 TEPŞİ TAŞIMA ARABASI  
37x53 TRAY TROLLEY

| KOD CODE   | [MM]         | PASLANMAZ TİPİ<br>S.S. TYPE | € |
|------------|--------------|-----------------------------|---|
| AIM 3753-1 | 430x570x1600 | 304                         | - |



30 TEPŞİ KAPASİTELİ  
30 TRAY CAPACITY37x53 TEPŞİ TAŞIMA ARABASI - İKİLİ  
37x53 TRAY TROLLEY - TWIN

| KOD CODE   | [MM]         | PASLANMAZ TİPİ<br>S.S. TYPE | € |
|------------|--------------|-----------------------------|---|
| AIM 3753-2 | 830x570x1600 | 304                         | - |

40x60 TEPŞİ TAŞIMA ARABASI  
40x60 TRAY TROLLEY

| KOD CODE   | [MM]         | PASLANMAZ TİPİ<br>S.S. TYPE | € |
|------------|--------------|-----------------------------|---|
| AIM 4060-1 | 440x630x1650 | 304                         | - |



NEW  
PRODUCTTABAK OTOMATI - TEKLİ  
PLATE DISPENSER - SINGLE

| KOD CODE  | <br>[ MM ] | TABAK KAPASİTE<br>PLATE CAPACITY | MODEL<br>TYPE     | € |
|---|---|----------------------------------|-------------------|---|
| AIM 1826N   | 500x440x940   | 18/26                            | NÖTR / NEUTRAL    | - |
| AIM 1826H  | 500x440x940   | 18/26                            | ISITMALI / HEATED | - |
| AIM 2432N   | 500x480x940   | 24/32                            | NÖTR / NEUTRAL    | - |
| AIM 2432H  | 500x480x940   | 24/32                            | ISITMALI / HEATED | - |

PLASTİK SERVİS ARABASI 2 KATLI  
PLASTIC SERVICE TROLLEY 2 LAYER

| KOD CODE  | <br>[ MM ] | € |
|-----------|---|---|
| AIM ST2-P | 530x970x970   | - |



TABAK OTOMATI - İKİLİ  
PLATE DISPENSER - TWIN

| KOD CODE  | <br>[ MM ] | TABAK KAPASİTE<br>PLATE CAPACITY | MODEL<br>TYPE     | € |
|---|---|----------------------------------|-------------------|---|
| AIM 1826N-2   | 720x440x940   | 18/26                            | NÖTR / NEUTRAL    | - |
| AIM 1826H-2  | 720x440x940   | 18/26                            | ISITMALI / HEATED | - |
| AIM 2432N-2   | 840x480x940   | 24/32                            | NÖTR / NEUTRAL    | - |
| AIM 2432H-2  | 840x480x940   | 24/32                            | ISITMALI / HEATED | - |

PLASTİK SERVİS ARABASI 3 KATLI  
PLASTIC SERVICE TROLLEY 3 LAYER

| KOD CODE  | <br>[ MM ] | € |
|-----------|---|---|
| AIM ST3-P | 530x970x970   | - |

TABAK OTOMATI - DÖRTLÜ  
PLATE DISPENSER - QUAD

| KOD CODE  | <br>[ MM ] | TABAK KAPASİTE<br>PLATE CAPACITY | MODEL<br>TYPE     | € |
|---|---|----------------------------------|-------------------|---|
| AIM 1826N-4   | 720x720x940   | 18/26                            | NÖTR / NEUTRAL    | - |
| AIM 1826H-4  | 720x720x940   | 18/26                            | ISITMALI / HEATED | - |
| AIM 2432N-4   | 840x840x940   | 24/32                            | NÖTR / NEUTRAL    | - |
| AIM 2432H-4  | 840x840x940   | 24/32                            | ISITMALI / HEATED | - |

PLASTİK SERVİS ARABASI 2 KATLI  
PLASTIC SERVICE TROLLEY 2 LAYER

| KOD CODE   | <br>[ MM ] | € |
|------------|---|---|
| AIM STK2-P | 530x970x970   | - |

## OPSİYONLAR / OPTIONS

|  |  |  |
|--|--|--|
|  CB |  OB |  TB |
|     |     |     |
| - €  | - €  | - €  |
| Plastik Çatak-Kaşık Kutusu<br>Plastic Cutlery Box  | Plastik Orta Boy Kutusu<br>Plastic Medium Box  | Plastik Çöp Kutusu<br>Plastic Trash Bin  |

Paket içeriği 5 adettir.  
Package includes 5 pieces.

# TABAK ARABASI - AYARLANABİLİR

## DISH TROLLEY - ADJUSTABLE

NEW  
PRODUCT



TABAK ARABASI - AYARLANABİLİR 4 BÖLMELİ  
DISH TROLLEY - ADJUSTABLE 4 DIVIDERS

| KOD CODE | [ MM ]      | TABAK KAPASİTE<br>PLATE CAPACITY | € |
|----------|-------------|----------------------------------|---|
| AIM DT-4 | 725x725x805 | Min. 180 - Max. 400              | - |

# KURU GIDA TAŞIMA ARABASI VE BEBEK SANDALYESİ

## INGREDIENT BIN AND BABY CHAIR

NEW  
PRODUCT



BEBEK SANDALYESİ  
BABY CHAIR

| KOD CODE | [ MM ]      | TAŞIMA KAPASİTESİ<br>WEIGHT CAPACITY | € |
|----------|-------------|--------------------------------------|---|
| AIM BC-6 | 560x590x770 | 40 kg                                | - |



TABAK ARABASI - AYARLANABİLİR 6 BÖLMELİ  
DISH TROLLEY - ADJUSTABLE 6 DIVIDERS

| KOD CODE | [ MM ]       | TABAK KAPASİTE<br>PLATE CAPACITY | € |
|----------|--------------|----------------------------------|---|
| AIM DT-6 | 1120x710x800 | Min. 180 - Max. 480              | - |



KURU GIDALAR İÇİN TAŞIMA ARABASI  
INGREDIENT BIN FOR DRY FOODS

| KOD CODE    | [ MM ]      | KAPASİTE<br>CAPACITY | € |
|-------------|-------------|----------------------|---|
| AIM ING-102 | 420x750x710 | 102 L                | - |



TABAK ARABASI - 6 BÖLMELİ (KARE + YUVARLAK TABAK)  
DISH TROLLEY - 6 DIVIDERS (SQUARE + OVAL PLATE)

| KOD CODE   | [ MM ]      | TABAK KAPASİTE<br>PLATE CAPACITY | € |
|------------|-------------|----------------------------------|---|
| AIM DT-6SO | 985x760x900 | Min. 180 - Max. 480              | - |



YALITIMLI BUZ ARABASI  
INSULATED ICE BIN CART

| KOD CODE    | [ MM ]      | KAPASİTE<br>CAPACITY | € |
|-------------|-------------|----------------------|---|
| AIM IBC-125 | 605x800x745 | 125 L                | - |
| AIM IBC-175 | 610x965x745 | 175 L                | - |



# TERMOBOX, ÜSTTEN YÜKLEMELİ

## THERMOBOX, TOP LOADING

RENK/  
COLORS

NEW  
PRODUCT



Standart GN küvetlere göre tasarlanmıştır.  
Standard GN containers are used as the design basis.

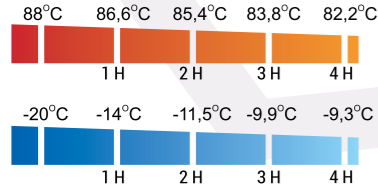

### TEKNİK DETAYLAR / TECHNICAL DETAILS

TR

- Gıda için uygun ve zararsız, düşük yoğunluklu polietilenden yapılmıştır.
- Çevre dostu, geri dönüştürülebilir, toksik olmayan, UV ışınlarına, sıcaklığa, soğuğa ve korozyona dayanıklı LLDPE malzeme.
- Çift duvar: İç ve dış duvar arasına CFC içermeyen poliüretan enjekte edilmiştir, 2,3" kalınlığında yalıtım.
- AISI 304 paslanmaz çelik vidalar.
- Kırılmaz PA6 Naylon menteşe ve mandallar.
- Üstten yüklemeli, -40 ila +100 °C arasında dayanıklı. Sıcak yemekler için saatte 1,5°C, soğuk yemekler için 1°C ısınma kaybı.
- Üst üste istiflenebilir, kolay depolama ve taşıma.
- Kolay kilit sistemi.

EN

- Made of low density polyethylene, suitable for food and harmless.
- Eco-friendly, recyclable, non-toxic, UV, heat, cold and corrosion resistant LLDPE material.
- Double wall: CFC-free polyurethane injected between inner and outer wall, 2.3" thick insulation.
- AISI 304 stainless steel screws.
- Unbreakable PA6 Nylon hinges and latches.
- Top loading, resistant from -40 to +100 °C. Heating loss of 1.5°C per hour for hot dishes and 1°C per hour for cold dishes.
- Stackable, easy storage and transportation.
- Easy locking system.

| KOD / CODE   | [MM]        | KAPASİTE / CAPACITY  | € |
|--------------|-------------|--|---|
| AIM TBOX-TL1 | 635x435x200 | GN 1/1 - 100mm [1 Adet/Pcs.] - 56 Pors./Port.<br>GN 1/2 - 100mm [2 Adet/Pcs.] - 24 Pors./Port.<br>GN 1/3 - 100mm [3 Adet/Pcs.] - 16 Pors./Port.  | - |
| AIM TBOX-TL2 | 635x435x250 | GN 1/1 - 150mm [1 Adet/Pcs.] - 84 Pors./Port.<br>GN 1/2 - 150mm [2 Adet/Pcs.] - 36 Pors./Port.<br>GN 1/3 - 150mm [3 Adet/Pcs.] - 23 Pors./Port.  | - |
| AIM TBOX-TL3 | 635x435x310 | GN 1/1 - 200mm [1 Adet/Pcs.] - 112 Pors./Port.<br>GN 1/2 - 200mm [2 Adet/Pcs.] - 50 Pors./Port.<br>GN 1/3 - 200mm [3 Adet/Pcs.] - 31 Pors./Port. | - |

# TERMOBOX, ÖNDEN YÜKLEMELİ

## THERMOBOX, FRONT LOADING

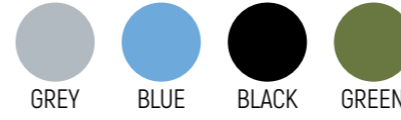
RENK/  
COLORS

NEW  
PRODUCT

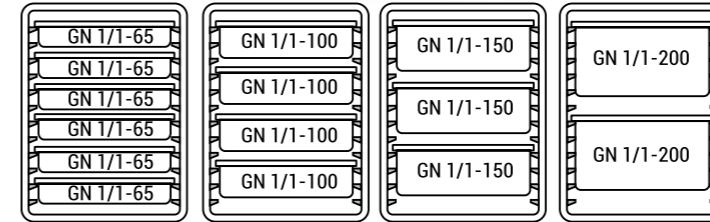

12 raf kazağına sahip thermobox, 1/1 GN küvetleri yerleştirerek kapasitesini kullanıcıya göre özelleştirme imkanı sunar.  
The thermobox with 12 rack slides allows users to customize its capacity by placing 1/1 GN containers as desired.

### TEKNİK DETAYLAR / TECHNICAL DETAILS

TR

- GN küvetlere göre tasarlanmış bu ürün, 12 raf kazağı ve 30 mm raf aralığına sahiptir.
- Gıda dostu, geri dönüştürülebilir polietilen malzemeden üretilmiştir.
- Çift cidarlı tasarımı ve CFC-free poliüretan yalıtımı ile yüksek ısı koruması sağlar.
- Monoblok gövde ve 270° açılabilen menteşe, dayanıklılık ve hijyen sunar.
- -40°C soğuğa, +100°C sığağa dayanıklıdır. Sıcak yemekler saatte 1,5°C soğur, soğuk yemekler ise 1°C ısınır.
- Gıda güvenliği için silikon conta ve bulaşık makinesinde yıkanabilir.

EN

- Designed for GN bathtubs, this product has 12 shelf slides and 30 mm shelf spacing.
- Made of food-friendly, recyclable polyethylene material.
- Its double-walled design and CFC-free polyurethane insulation provide high heat protection.
- Monoblock body and 270° hinge for durability and hygiene.
- Resistant to -40°C cold and +100°C heat. Hot meals cool down by 1.5°C per hour and cold meals warm up by 1°C per hour.
- Silicone gasket for food safety and dishwasher safe.

| KOD / CODE      | [MM]        | € |
|-----------------|-------------|---|
| AIM TBOX-FL1    | 465x610x630 | - |
| AIM TBOX-FL1-TR | 680x540x160 | - |

# RENK KARTELASI COLOR CHART



**AVRUPA TEAK**  
EUROPEAN TEAK

**ARAL**  
ARAL

**LATİN CEVİZ**  
LATIN WALNUT

**ARGOS**  
ARGOS



**GOLD WEST**  
ALTIN BATI

**METALİK CEVİZ**  
METALLIC WALNUT

**BAROK**  
BAROK

**İTALYAN CEVİZ**  
ITALIAN WALNUT



**SORRENTO**  
SORRENTO

**İNEGÖL**  
INEGOL

**MERKÜR**  
MERCURY

**MİLANO**  
MILANO



**PERA**  
PERA

**ODESA**  
ODESA

**VENUS**  
VENUS

**CENNET**  
PARADISE



**KAPRI**  
CAPRI

**MALTA**  
MALTA

# FLAMBE ARABALARI FLAMBE TROLLEY

**NEW  
PRODUCT**

| KOD CODE  | (MM)        | € |
|-----------|-------------|---|
| AIM FLT-2 | 870x480x770 | - |

## TEKNİK DETAYLAR / TECHNICAL DETAILS

TR

- Yüksek kaliteli ve dayanıklı ahşap gövde, uzun ömürlü kullanım için tasarlanmıştır.
- Paslanmaz çelik üst tezgah
- 2 adet tek gözlü cam ankastre wok ocak
- Otomatik ateşleme
- Gaz emniyet ventilli
- 2 adet çekmeceli
- Sos rafı
- İki frenli olmak üzere 4 adet tekerlek mevcuttur.
- İki taraftan da tutulabilir, pratik taşıma imkanı sunar.
- Kompakt yapısı ile alan tasarrufu sağlar, aynı zamanda yeterli depolama alanı sunar.
- Farklı renk seçenekleri mevcuttur.

EN

- High-quality and durable wooden body, designed for long-lasting use.
- Stainless steel top worktop
- 2 single-burner glass built-in wok stoves
- Automatic ignition
- Gas safety valve
- 2 drawers
- Sauce rack
- Equipped with 4 wheels, two of which are lockable.
- Can be held from both sides, offering convenient portability.
- Its compact design saves space while providing ample storage capacity.
- Different color options are available.



| KOD CODE  | (MM)        | € |
|-----------|-------------|---|
| AIM FLT-1 | 830x480x770 | - |

## TEKNİK DETAYLAR / TECHNICAL DETAILS

TR

- Yüksek kaliteli ve dayanıklı ahşap gövde, uzun ömürlü kullanım için tasarlanmıştır.
- Paslanmaz çelik üst tezgah
- 1 adet tek gözlü cam ankastre wok ocak
- Otomatik ateşleme
- Gaz emniyet ventilli
- 1 adet çekmeceli
- Sos rafı
- İki frenli olmak üzere 4 adet tekerlek mevcuttur.
- İki taraftan da tutulabilir, pratik taşıma imkanı sunar.
- Kompakt yapısı ile alan tasarrufu sağlar, aynı zamanda yeterli depolama alanı sunar.
- Farklı renk seçenekleri mevcuttur.

EN

- High-quality and durable wooden body, designed for long-lasting use.
- Stainless steel top worktop
- Single-burner glass built-in wok stoves
- Automatic ignition
- Gas safety valve
- 1 drawer
- Sauce rack
- Equipped with 4 wheels, two of which are lockable.
- Can be held from both sides, offering convenient portability.
- Its compact design saves space while providing ample storage capacity.
- Different color options are available.

# AHŞAP SERVİS ARABALARI

## WOODEN SERVICE TROLLEY

NEW  
PRODUCT



| KOD CODE  | [MM]        | € |
|-----------|-------------|---|
| AIM ST2-W | 870x480x770 | - |

### TEKNİK DETAYLAR / TECHNICAL DETAILS

TR

- Yüksek kaliteli ve dayanıklı ahşap gövde, uzun ömürlü kullanım için tasarlanmıştır.
- Çekmeceler; 6 adet bölmeden oluşmaktadır.
- İki frenli olmak üzere 4 adet tekerlek mevcuttur.
- İki taraftan da tutulabilir, pratik taşıma imkanı sunar.
- Kompakt yapısı ile alan tasarrufu sağlar, aynı zamanda yeterli depolama alanı sunar.
- Farklı renk seçenekleri mevcuttur.

EN

- High-quality and durable wooden body, designed for long-lasting use.
- The drawers consist of 6 compartments.
- Equipped with 4 wheels, two of which are lockable.
- Can be held from both sides, offering convenient portability.
- Its compact design saves space while providing ample storage capacity.
- Different color options are available.



| KOD CODE  | [MM]        | € |
|-----------|-------------|---|
| AIM ST3-W | 830x480x770 | - |

### TEKNİK DETAYLAR / TECHNICAL DETAILS

TR

- Yüksek kaliteli ve dayanıklı ahşap gövde, uzun ömürlü kullanım için tasarlanmıştır.
- Servis çekmecesini
- İki frenli olmak üzere 4 adet tekerlek mevcuttur.
- İki taraftan da tutulabilir, pratik taşıma imkanı sunar.
- Kompakt yapısı ile alan tasarrufu sağlar, aynı zamanda yeterli depolama alanı sunar.
- Farklı renk seçenekleri mevcuttur.

EN

- High-quality and durable wooden body, designed for long-lasting use.
- With service drawer
- Equipped with 4 wheels, two of which are lockable.
- Can be held from both sides, offering convenient portability.
- Its compact design saves space while providing ample storage capacity.
- Different color options are available.

# AHŞAP SERVANT MASASI

## WOODEN SERVICE TABLE

NEW  
PRODUCT



| KOD CODE  | [MM]         | € |
|-----------|--------------|---|
| AIM SER-1 | 830x430x1050 | - |

### TEKNİK DETAYLAR / TECHNICAL DETAILS

TR

- MDF LAM malzemeden üretilmiştir.
- 2 geniş çekmeceye sahiptir.
- 2 kapaklı dolap bölümü bulunmaktadır.
- Yüksek kaliteli ve dayanıklı ahşap gövde, uzun ömürlü kullanım için tasarlanmıştır.
- Farklı renk seçenekleri mevcuttur.

EN

- Made of MDF LAM material.
- 2 wide drawers.
- 2 cabinet compartments with doors.
- High quality and durable wooden body is designed for long-lasting use.
- Different color options are available.

| KOD CODE  | [MM]         | € |
|-----------|--------------|---|
| AIM SER-2 | 830x430x1290 | - |

### TEKNİK DETAYLAR / TECHNICAL DETAILS

TR

- MDF LAM malzemeden üretilmiştir.
- 2 geniş çekmeceye sahiptir.
- 2 kapaklı dolap bölümü bulunmaktadır.
- Tekerlekli yapısı sayesinde kullanıcıya büyük bir pratiklik sağlar.
- Yüksek kaliteli ve dayanıklı ahşap gövde, uzun ömürlü kullanım için tasarlanmıştır.
- Farklı renk seçenekleri mevcuttur.

EN

- Made of MDF LAM material.
- 2 wide drawers.
- 2 cabinet compartments with doors.
- It provides great practicality to the user thanks to its wheeled structure.
- High quality and durable wooden body is designed for long-lasting use.
- Different color options are available.



| KOD CODE  | [MM]         | € |
|-----------|--------------|---|
| AIM SER-3 | 830x430x1290 | - |

### TEKNİK DETAYLAR / TECHNICAL DETAILS

TR

- MDF LAM malzemeden üretilmiştir.
- 2 geniş çekmeceye sahiptir.
- 2 kapaklı dolap bölümü bulunmaktadır.
- Yüksek kaliteli ve dayanıklı ahşap gövde, uzun ömürlü kullanım için tasarlanmıştır.
- Farklı renk seçenekleri mevcuttur.

EN

- Made of MDF LAM material.
- 2 wide drawers.
- 2 cabinet compartments with doors.
- High quality and durable wooden body is designed for long-lasting use.
- Different color options are available.

# MODULER KAHVE BAR TEZGAHLARI



# MODULAR CAFE BAR COUNTERS



# MODÜLER KAHVE BAR TEZGAHLARI

## MODULAR CAFE BAR COUNTERS

BAR TEZGAHI - EYELİ VE BUZ HAZNELİ  
BAR COUNTER - W/SINK & ICE BIN

NEW  
PRODUCT



### TEKNİK DETAYLAR / TECHNICAL DETAILS

TR

- Paslanmaz Çelik AISI 304'ten üretilmiştir.
- Üst tabla kalınlığı 1.2 mm'dir.
- Eveye boyutları [BxExY]: 305x335x200 mm.
- 300x200x300 mm izolasyonlu buz haznesine sahiptir.
- Çarpma kapaklıdır.
- MDF ile güçlendirilmiş, ses geçirmez çalışma yüzeyi bulunur.
- Ayak kısımları opsiyonel olarak baza ile kapatılabilir.
- Standart 10 cm sırtlıklardır.

EN

- Brushed structure stainless steel AISI 304
- Top plate thickness is 1.2 mm.
- Sink dimensions [BxExY]: 305x335x200 mm.
- It has a 300x200x300 mm insulated ice well.
- Hinged doors.
- Soundproof work surface reinforced with MDF.
- Foot parts can be optionally covered with plinth.
- Standard 10 cm backsplash.

### TEKNİK ÇİZİM / TECHNICAL DRAWING

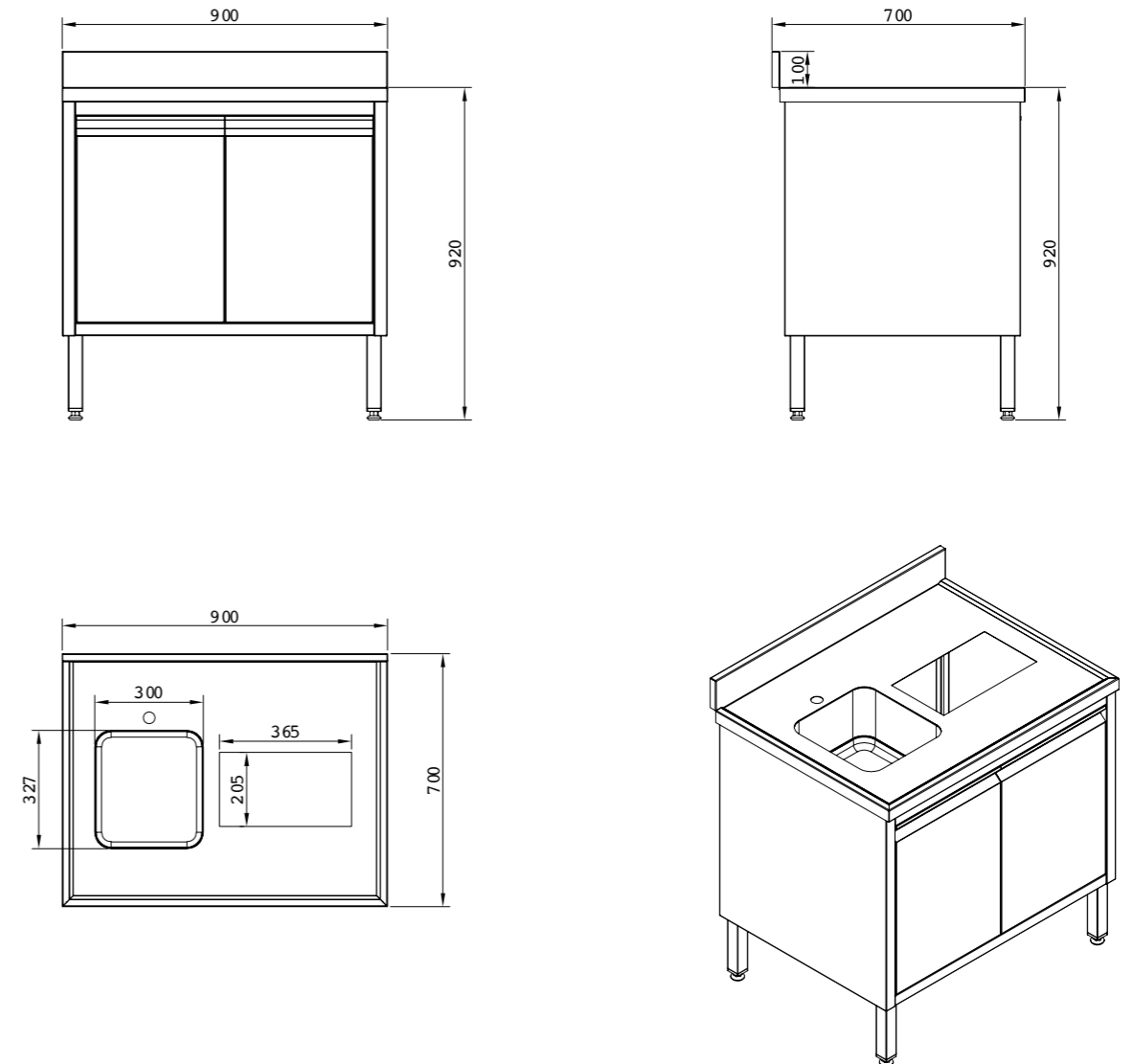

| KOD CODE     |              | [MM]         | SINK SIDE |      | € |
|--------------|--------------|--------------|-----------|------|---|
| IS-L         | IS-R         |              | IS-L      | IS-R |   |
| AIM-97-IS-L  | AIM-97-IS-R  | 900x700x920  |           |      | - |
| AIM-127-IS-L | AIM-127-IS-R | 1200x700x920 |           |      | - |
| AIM-157-IS-L | AIM-157-IS-R | 1500x700x920 |           |      | - |
| AIM-187-IS-L | AIM-187-IS-R | 1800x700x920 |           |      | - |

# MODÜLER KAHVE BAR TEZGAHLARI

## MODULAR CAFE BAR COUNTERS

BAR TEZGAHI - KAHVE ÇEKMECELİ  
BAR COUNTER - W/COFFEE KNOCK OUT DRAWERS

NEW  
PRODUCT



| KOD CODE    | (MM)         | € |
|-------------|--------------|---|
| AIM-97-CDL  | 900x700x920  | - |
| AIM-127-CDL | 1200x700x920 | - |
| AIM-157-CDL | 1500x700x920 | - |
| AIM-187-CDL | 1800x700x920 | - |

### TEKNİK DETAYLAR / TECHNICAL DETAILS

TR

- Paslanmaz Çelik AISI 304'ten üretilmiştir.
- Üst tabla kalınlığı 1.2 mm'dir.
- 2 adet posa kahve posa çekmecesi mevcuttur.
- Çarpma kapaklıdır.
- MDF ile güçlendirilmiş, ses geçirmez çalışma yüzeyi bulunur.
- Ayak kısımları opsiyonel olarak baza ile kapatılabilir.
- Standart 10 cm sırtlıklıdır.

EN

- Brushed structure stainless steel AISI 304
- Top plate thickness is 1.2 mm.
- 2 no's of coffee knock out drawers.
- Hinged doors.
- Soundproof work surface reinforced with MDF.
- Foot parts can be optionally covered with plinth.
- Standard 10 cm backplash.

### TEKNİK ÇİZİM / TECHNICAL DRAWING

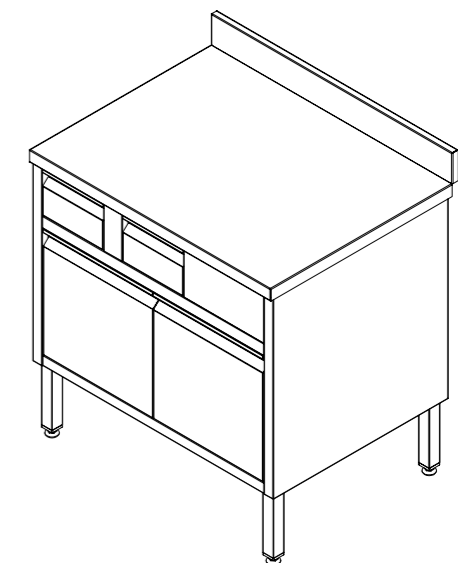
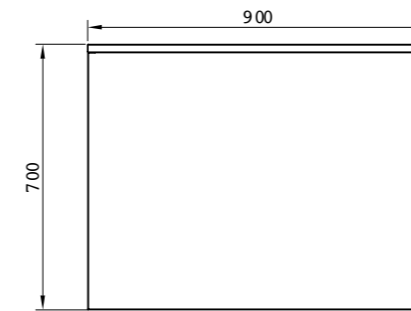
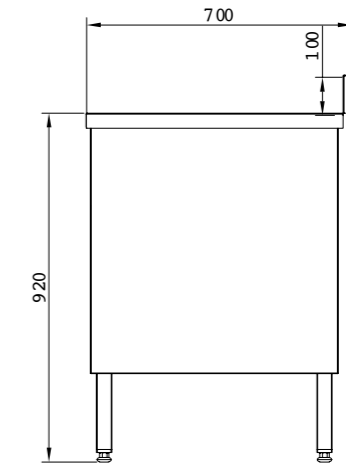
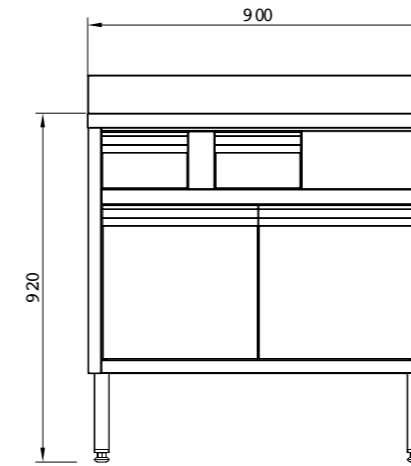

# MODÜLER KAHVE BAR TEZGAHLARI

## MODULAR CAFE BAR COUNTERS

BAR TEZGAHI - KAHVE ÇEKMECELİ VE DUŞLAMA ÜNİTELİ  
BAR COUNTER - W/COFFEE KNOCK OUT & DRAWERS WASHER UNIT

NEW  
PRODUCT



### TEKNİK DETAYLAR / TECHNICAL DETAILS

TR

- Paslanmaz Çelik AISI 304'ten üretilmiştir.
- Üst tabla kalınlığı 1.2 mm'dir.
- 2 adet posa kahve posa çekmecesi mevcuttur.
- 400x230 ebatında duşlama ünitesi.
- Çarpma kapaklıdır.
- MDF ile güçlendirilmiş, ses geçirmez çalışma yüzeyi bulunur.
- Ayak kısımları opsiyonel olarak baza ile kapatılabilir.
- Standart 10 cm sırtlıklıdır.

EN

- Brushed structure stainless steel AISI 304
- Top plate thickness is 1.2 mm.
- 2 no's of coffee knock out drawers.
- 400x230 size washer unit.
- Hinged doors.
- Soundproof work surface reinforced with MDF.
- Foot parts can be optionally covered with plinth.
- Standard 10 cm backsplash.

### TEKNİK ÇİZİM / TECHNICAL DRAWING

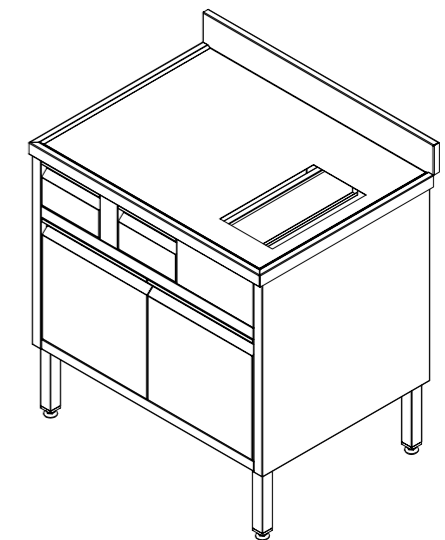
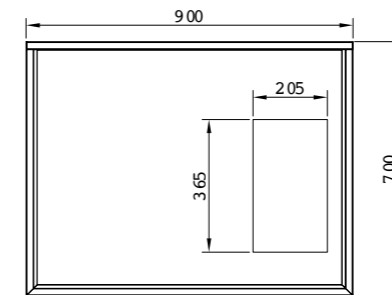
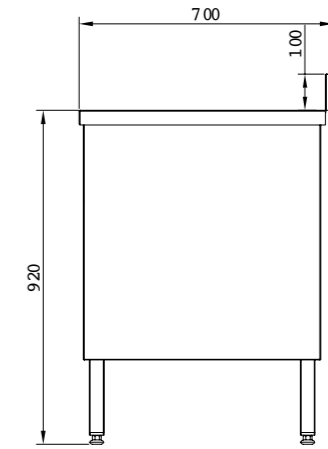
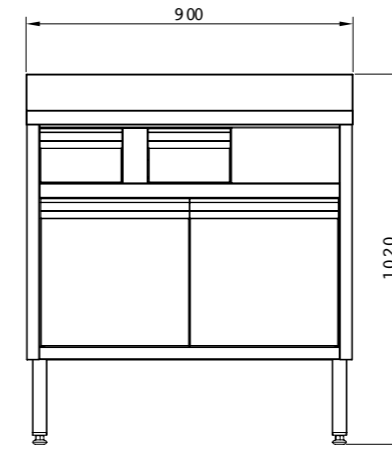

| KOD CODE        |                 | RINSER SIDE  | € |
|-----------------|-----------------|--------------|---|
| CDL-L           | CDL-R           |              |   |
| AIM-97-CDR-RSL  | AIM-97-CDL-RSR  | 900x700x920  | - |
| AIM-127-CDR-RSL | AIM-127-CDL-RSR | 1200x700x920 | - |
| AIM-157-CDR-RSL | AIM-157-CDL-RSR | 1500x700x920 | - |
| AIM-187-CDR-RSL | AIM-187-CDL-RSR | 1800x700x920 | - |

# MODÜLER KAHVE BAR TEZGAHLARI MODULAR CAFE BAR COUNTERS

BAR TEZGAHI - KAHVE ÇEKMECELİ VE AIM 140 BOŞLUKLU  
BAR COUNTER - W/COFFEE KNOCK OUT & DRAWER SPACE FOR AIM 140

NEW  
PRODUCT



| KOD CODE         |                  | RINSER SIDE  | € |
|------------------|------------------|--------------|---|
| CD-L             | CD-R             |              |   |
| AIM-127-CD-OTS-L | AIM-127-CD-OTS-R | 1200x700x920 | - |
| AIM-147-CD-OTS-L | AIM-147-CD-OTS-R | 1400x700x920 | - |

## TEKNİK DETAYLAR / TECHNICAL DETAILS

TR

- Paslanmaz Çelik AISI 304'ten üretilmiştir.
- Üst tabla kalınlığı 1.2 mm'dir.
- 1 adet posa kahve posa çekmecesi mevcuttur.
- Boşluk ebatı: 600x640x820
- Çarpma kapaklıdır.
- MDF ile güçlendirilmiş, ses geçirmez çalışma yüzeyi bulunur.
- Ayak kısımları opsiyonel olarak baza ile kapatılabilir.
- Standart 10 cm sırtlıklardır.

EN

- Brushed structure stainless steel AISI 304
- Top plate thickness is 1.2 mm.
- 1 no of coffee knock out drawer.
- Space size: 600x640x820
- Hinged doors.
- Soundproof work surface reinforced with MDF.
- Foot parts can be optionally covered with plinth.
- Standard 10 cm backslash.

## TEKNİK ÇİZİM / TECHNICAL DRAWING

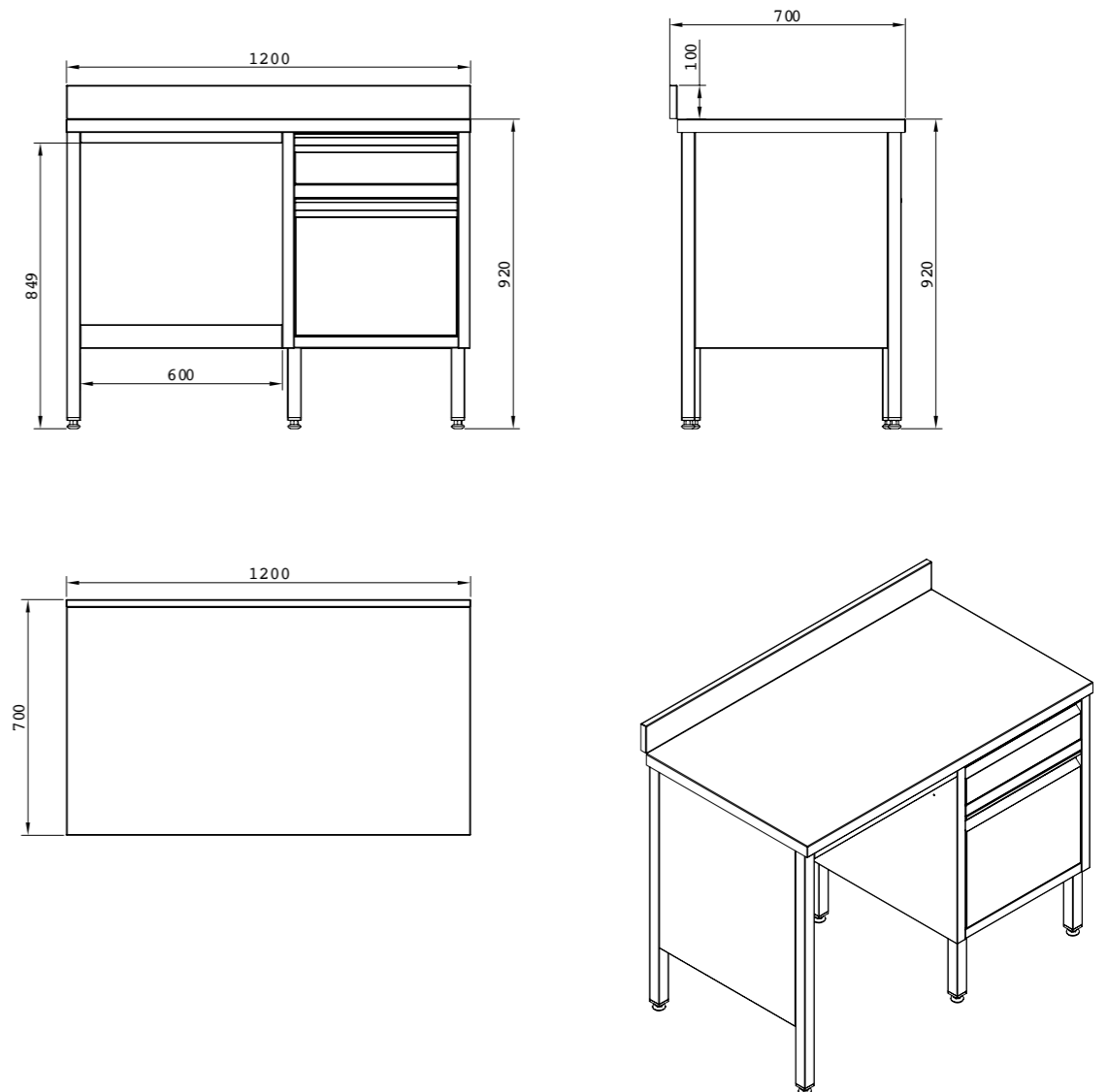

# MODÜLER KAHVE BAR TEZGAHLARI

## MODULAR CAFE BAR COUNTERS

BAR TEZGAHI - ŞİŞE SOĞUTUCU BOŞLUKLU  
BAR COUNTER WITH SPACE FOR BOTTLE COOLER

NEW  
PRODUCT



| KOD CODE      | ↑<br>[MM]    | ŞİŞE SOĞUTUCU<br>ADETİ<br>BOTTLE COOLER QTY | € |
|---------------|--------------|---|---|
| AIM-107-BC2   | 1000x700x920 | 1 x 2 Doors                                 | - |
| AIM-217-BC2-2 | 2100x700x920 | 2 x 2 Doors                                 | - |

### TEKNİK DETAYLAR / TECHNICAL DETAILS

TR

- Paslanmaz Çelik AISI 304'ten üretilmiştir.
- Üst tabla kalınlığı 1.2 mm'dir.
- Şişe soğutucu boşluğu: 920x500x870.
- MDF ile güçlendirilmiş, ses geçirmez çalışma yüzeyi bulunur.
- Ayak kısımları opsiyonel olarak baza ile kapatılabilir.
- Standart 10 cm sırtlıklardır.

EN

- Brushed structure stainless steel AISI 304
- Top plate thickness is 1.2 mm.
- Bottle cooler space: 920x500x870.
- Soundproof work surface reinforced with MDF.
- Foot parts can be optionally covered with plinth.
- Standard 10 cm backslash.

### TEKNİK ÇİZİM / TECHNICAL DRAWING

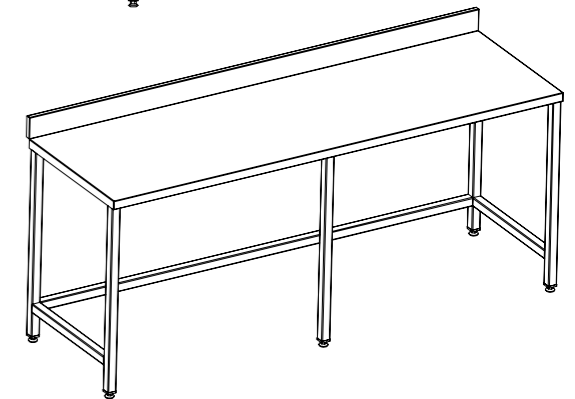
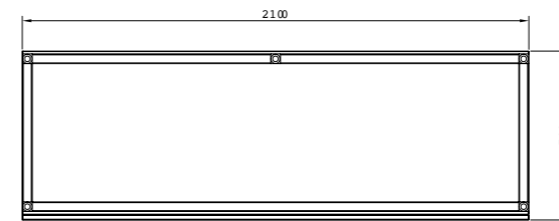
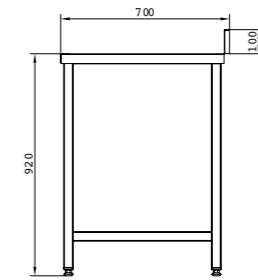
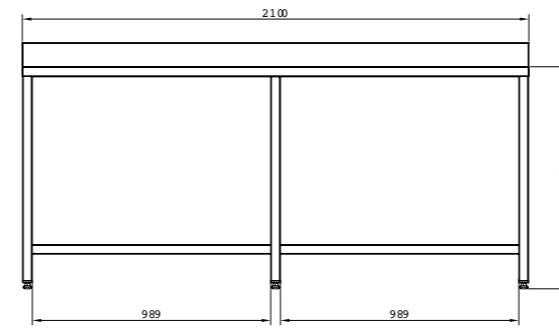

# MODÜLER KAHVE BAR TEZGAHLARI

## MODULAR CAFE BAR COUNTERS

BAR TEZGAHI - ŞİŞE SOĞUTUCU BOŞLUKLU  
BAR COUNTER WITH SPACE FOR BOTTLE COOLER

NEW  
PRODUCT



| KOD CODE      | ↑<br>[MM]    | ŞİŞE SOĞUTUCU<br>ADETİ<br>BOTTLE COOLER QTY | € |
|---------------|--------------|---|---|
| AIM-157-BC3   | 1500x700x920 | 1 x 3 Doors                                 | - |
| AIM-297-BC3-2 | 2900x700x920 | 2 x 3 Doors                                 | - |

### TEKNİK DETAYLAR / TECHNICAL DETAILS

TR

- Paslanmaz Çelik AISI 304'ten üretilmiştir.
- Üst tabla kalınlığı 1.2 mm'dir.
- Şişe soğutucu boşluğu: 1380x500x870
- MDF ile güçlendirilmiş, ses geçirmez çalışma yüzeyi bulunur.
- Ayak kısımları opsiyonel olarak baza ile kapatılabilir.
- Standart 10 cm sırtlıklardır.

EN

- Brushed structure stainless steel AISI 304
- Top plate thickness is 1.2 mm.
- Bottle cooler space: 1380x500x870
- Soundproof work surface reinforced with MDF.
- Foot parts can be optionally covered with plinth.
- Standard 10 cm backslash.

### TEKNİK ÇİZİM / TECHNICAL DRAWING

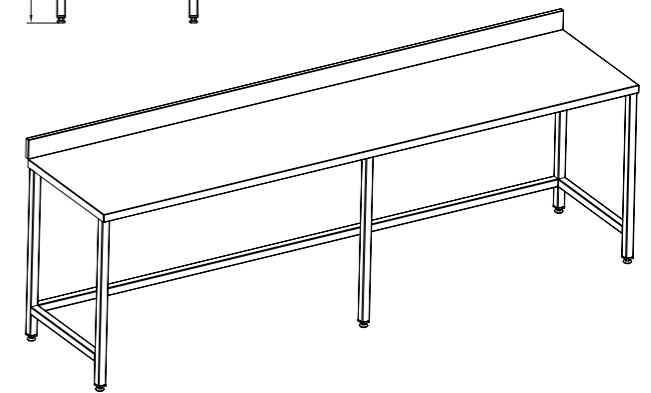
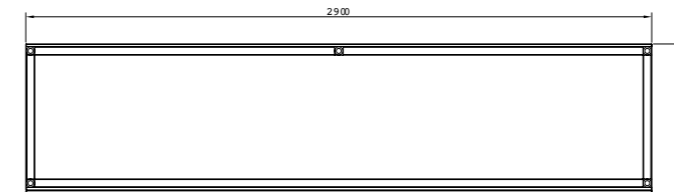
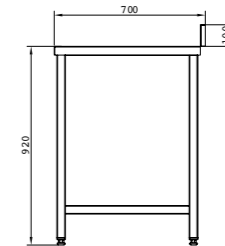
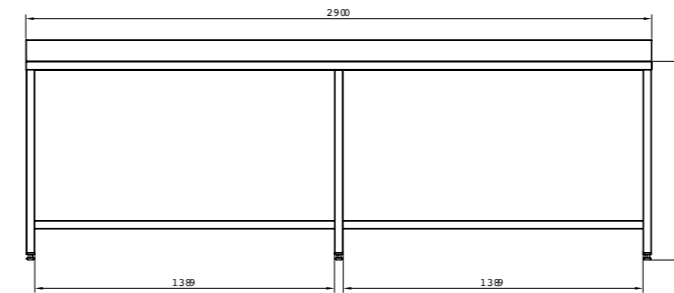

# MODÜLER KAHVE BAR TEZGAHLARI

## MODULAR CAFE BAR COUNTERS

**BAR TEZGAHI - 30 KG BUZ MAKİNESİ BOŞLUKLU**  
**BAR COUNTER WITH SPACE FOR 30 KG ICE CUBE MAKER**

**NEW  
PRODUCT**



| KOD CODE        |                 | ↑<br>[MM]    | ICE CUBE MACHINE SIDE    |                          | € |
|-----------------|-----------------|--------------|--------------------------|--------------------------|---|
| L               | R               |              | L                        | R                        |   |
| AIM-107-AIM30-L | AIM-107-AIM30-R | 1000x700x920 | <input type="checkbox"/> | <input type="checkbox"/> | - |
| AIM-157-AIM30-L | AIM-157-AIM30-R | 1500x700x920 | <input type="checkbox"/> | <input type="checkbox"/> | - |

### TEKNİK DETAYLAR / TECHNICAL DETAILS

TR

- Paslanmaz Çelik AISI 304'ten üretilmiştir.
- Üst tabla kalınlığı 1.2 mm'dir.
- Boşluk ebatı: 309x600x730
- Çarpma kapaklıdır.
- MDF ile güçlendirilmiş, ses geçirmez çalışma yüzeyi bulunur.
- Ayak kısımları opsiyonel olarak baza ile kapatılabilir.
- Standart 10 cm sırtlıklardır.

EN

- Brushed structure stainless steel AISI 304
- Top plate thickness is 1.2 mm.
- Space size: 309x600x730
- Hinged doors.
- Soundproof work surface reinforced with MDF.
- Foot parts can be optionally covered with plinth.
- Standard 10 cm backsplash.

### TEKNİK ÇİZİM / TECHNICAL DRAWING

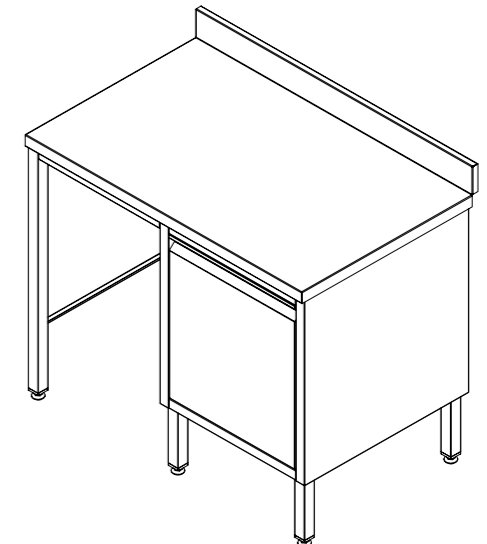
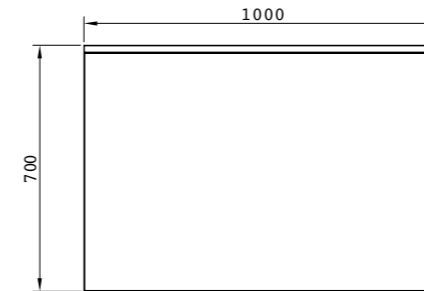
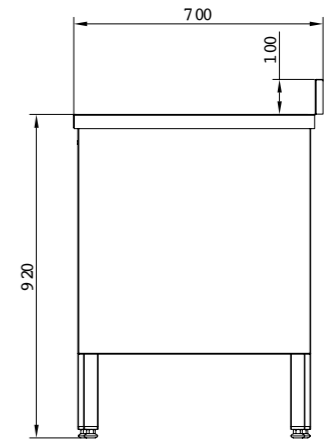
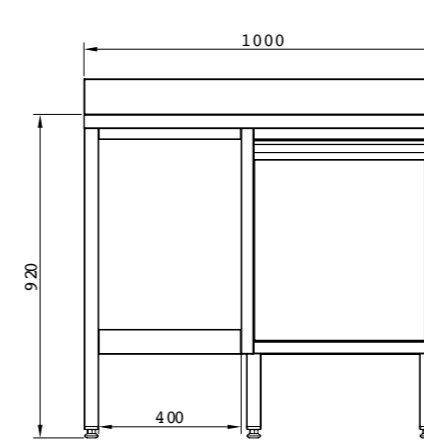

# MODÜLER KAHVE BAR TEZGAHLARI

## MODULAR CAFE BAR COUNTERS

BAR TEZGAHI - 50 KG BUZ MAKİNESİ BOŞLUKLU  
BAR COUNTER WITH SPACE FOR 50 KG ICE CUBE MAKER

NEW  
PRODUCT



### TEKNİK DETAYLAR / TECHNICAL DETAILS

TR

- Paslanmaz Çelik AISI 304'ten üretilmiştir.
- Üst tabla kalınlığı 1.2 mm'dir.
- Boşluk ebatı: 473x600x820
- Çarpma kapaklıdır.
- MDF ile güçlendirilmiş, ses geçirmez çalışma yüzeyi bulunur.
- Ayak kısımları opsiyonel olarak baza ile kapatılabilir.
- Standart 10 cm sırtlıklıdır.

EN

- Brushed structure stainless steel AISI 304
- Top plate thickness is 1.2 mm.
- Space size: 473x600x820
- Hinged doors.
- Soundproof work surface reinforced with MDF.
- Foot parts can be optionally covered with plinth.
- Standard 10 cm backsplash.

### TEKNİK ÇİZİM / TECHNICAL DRAWING

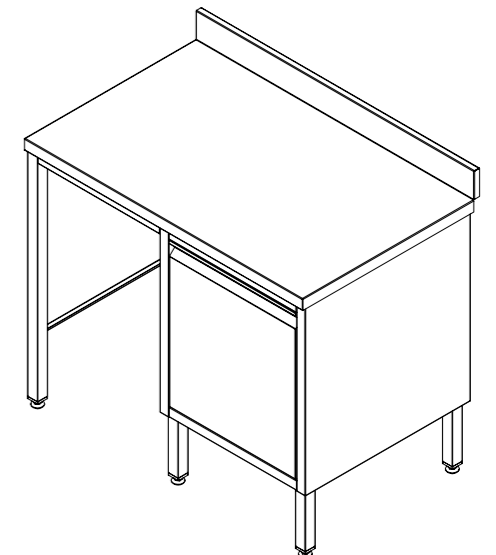
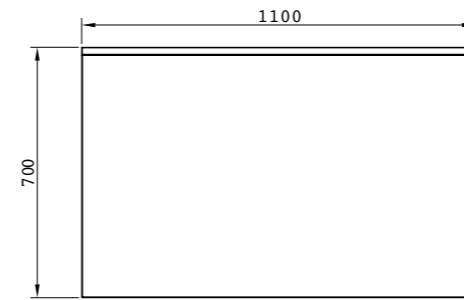
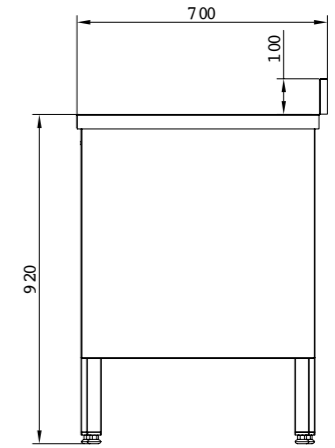
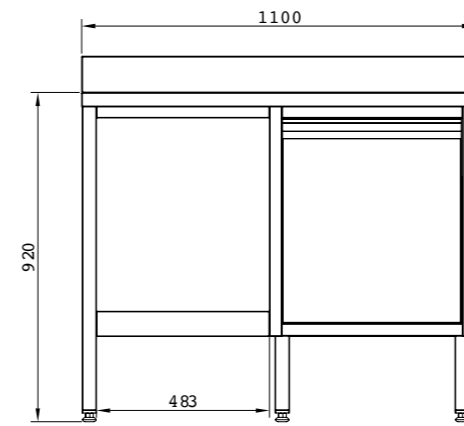

| KOD CODE        |                 | [MM]         | ICE CUBE MACHINE SIDE |   | € |
|-----------------|-----------------|--------------|-----------------------|---|---|
| L               | R               |              | L                     | R |   |
| AIM-117-AIM50-L | AIM-117-AIM50-R | 1100x700x920 |                       |   | - |
| AIM-167-AIM50-L | AIM-167-AIM50-R | 1600x700x920 |                       |   | - |

# MODÜLER KAHVE BAR TEZGAHLARI

## MODULAR CAFE BAR COUNTERS

**BAR TEZGAHI - 90 KG BUZ MAKİNESİ BOŞLUKLU**  
**BAR COUNTER WITH SPACE FOR 90 KG ICE CUBE MAKER**

**NEW  
PRODUCT**



| KOD CODE        |                 | ICE CUBE MACHINE SIDE | € |
|-----------------|-----------------|-----------------------|---|
| L               | R               |                       |   |
| AIM-127-AIM90-L | AIM-127-AIM90-R | 1200x700x920          | - |
| AIM-177-AIM90-L | AIM-177-AIM90-R | 1700x700x920          | - |

### TEKNİK DETAYLAR / TECHNICAL DETAILS

TR

- Paslanmaz Çelik AISI 304'ten üretilmiştir.
- Üst tabla kalınlığı 1.2 mm'dir.
- Boşluk ebatı: 610x600x820
- Çarpma kapaklıdır.
- MDF ile güçlendirilmiş, ses geçirmez çalışma yüzeyi bulunur.
- Ayak kısımları opsiyonel olarak baza ile kapatılabilir.
- Standart 10 cm sırtlıklıdır.

EN

- Brushed structure stainless steel AISI 304
- Top plate thickness is 1.2 mm.
- Space size: 610x600x820
- Hinged doors.
- Soundproof work surface reinforced with MDF.
- Foot parts can be optionally covered with plinth.
- Standard 10 cm backsplash.

### TEKNİK ÇİZİM / TECHNICAL DRAWING

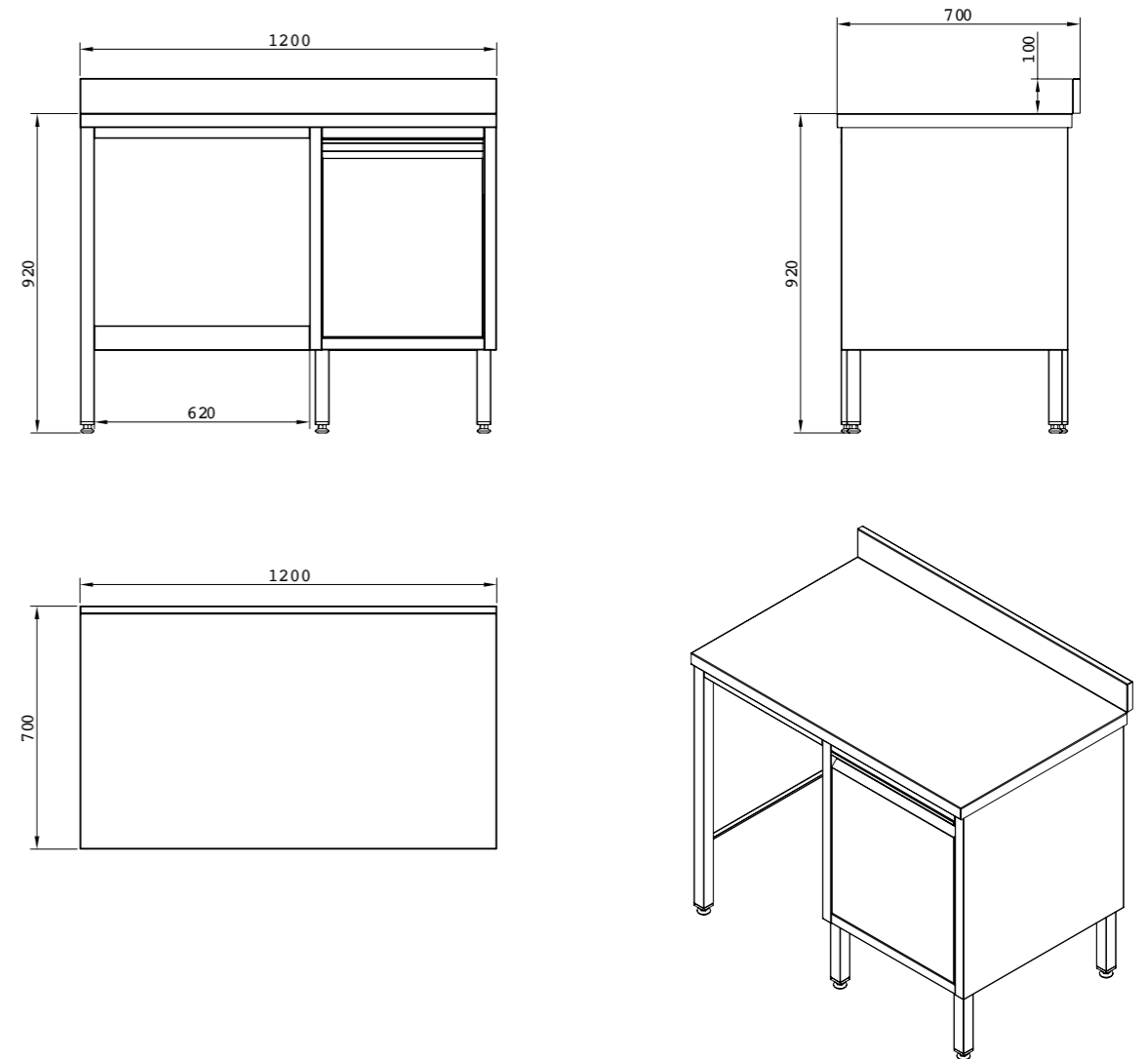

# MODÜLER KAHVE BAR TEZGAHLARI

## MODULAR CAFE BAR COUNTERS

BAR TEZGAHI - EYELİ VE BYM BOŞLUKLU  
BAR COUNTER WITH SINK & SPACE FOR DISHWASHER

NEW  
PRODUCT



IW35

| KOD CODE       |                | [MM]         | DISHWASHER SIDE          |                          | € |
|----------------|----------------|--------------|--------------------------|--------------------------|---|
| L              | R              |              | L                        | R                        |   |
| AIM-107-IW35-L | AIM-107-IW35-R | 1000x700x920 | <input type="checkbox"/> | <input type="checkbox"/> | - |

### TEKNİK DETAYLAR / TECHNICAL DETAILS

TR

- Paslanmaz Çelik AISI 304'ten üretilmiştir.
- Üst tabla kalınlığı 1.2 mm'dir.
- Eyye boyutları [BxExY]: 400x400x300 mm.
- Boşluk ebatı: 435x492x687.
- Çarpma kapaklıdır.
- MDF ile güçlendirilmiş, ses geçirmez çalışma yüzeyi bulunur.
- Ayak kısımları opsiyonel olarak baza ile kapatılabilir.
- Standart 10 cm sırtlıklıdır.

EN

- Brushed structure stainless steel AISI 304
- Top plate thickness is 1.2 mm.
- Sink dimensions [BxExY]: 400x400x300 mm.
- Space Size: 435x492x687.
- Hinged doors.
- Soundproof work surface reinforced with MDF.
- Foot parts can be optionally covered with plinth.
- Standard 10 cm backslash.

### TEKNİK ÇİZİM / TECHNICAL DRAWING

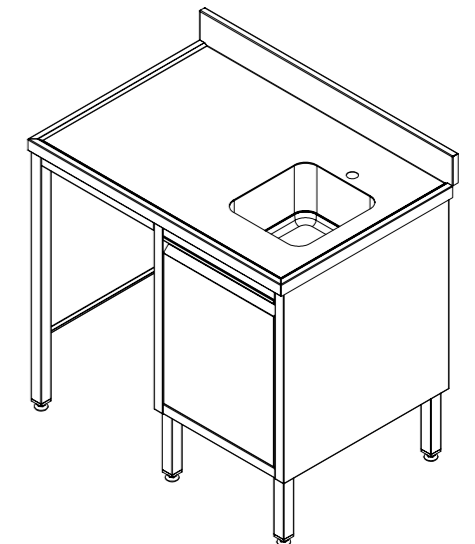
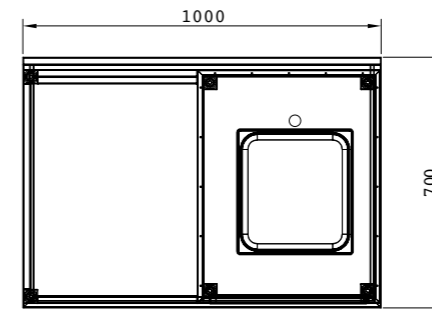
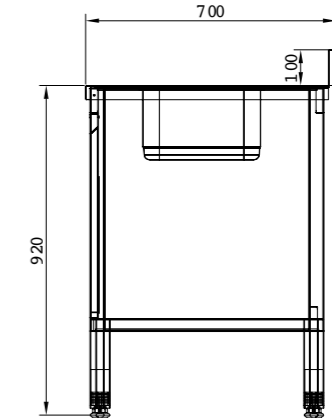
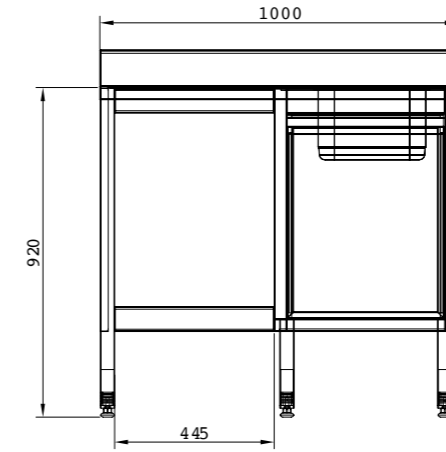

# MODÜLER KAHVE BAR TEZGAHLARI MODULAR CAFE BAR COUNTERS

BAR TEZGAHI - EYELİ VE BYM BOŞLUKLU  
BAR COUNTER WITH SINK & SPACE FOR DISHWASHER

NEW  
PRODUCT



IW40

| KOD CODE       |                | [MM]         | DISHWASHER SIDE          |                          | € |
|----------------|----------------|--------------|--------------------------|--------------------------|---|
| L              | R              |              | L                        | R                        |   |
| AIM-147-IW40-L | AIM-147-IW40-R | 1400x700x920 | <input type="checkbox"/> | <input type="checkbox"/> | - |

## TEKNİK DETAYLAR / TECHNICAL DETAILS

TR

- Paslanmaz Çelik AISI 304'ten üretilmiştir.
- Üst tabla kalınlığı 1.2 mm'dir.
- Eveye boyutları [BxExY]: 400x400x300 mm.
- Boşluk ebatı: 485x520x760.
- Çarpma kapaklıdır.
- MDF ile güçlendirilmiş, ses geçirmez çalışma yüzeyi bulunur.
- Ayak kısımları opsiyonel olarak baza ile kapatılabilir.
- Standart 10 cm sırtlıklıdır.

EN

- Brushed structure stainless steel AISI 304
- Top plate thickness is 1.2 mm.
- Sink dimensions [BxExY]: 400x400x300 mm.
- Space Size: 485x520x760.
- Hinged doors.
- Soundproof work surface reinforced with MDF.
- Foot parts can be optionally covered with plinth.
- Standard 10 cm backsplash.

## TEKNİK ÇİZİM / TECHNICAL DRAWING

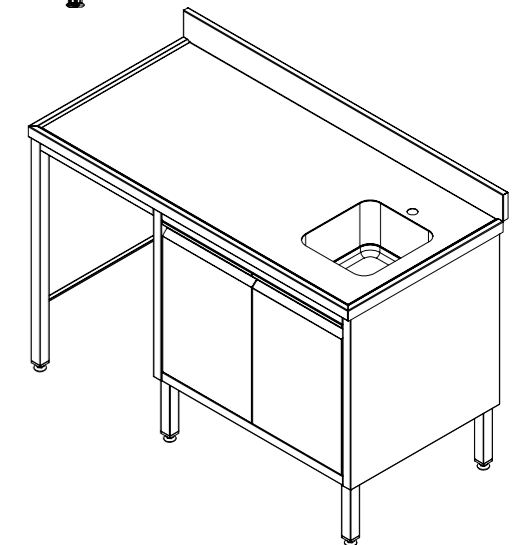
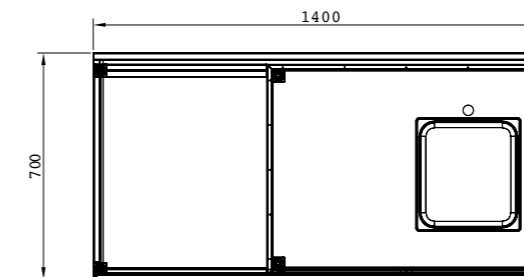
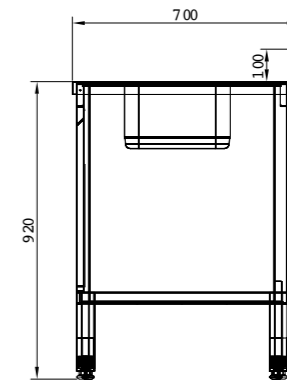
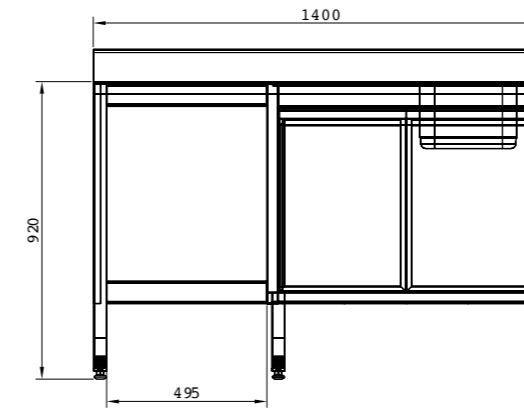

# MODÜLER KAHVE BAR TEZGAHLARI

## MODULAR CAFE BAR COUNTERS

BAR TEZGAHI - EYELİ VE BYM BOŞLUKLU  
BAR COUNTER WITH SINK & SPACE FOR DISHWASHER

NEW  
PRODUCT



IW50

| KOD CODE       |                | [MM]         | DISHWASHER SIDE          |                          | € |
|----------------|----------------|--------------|--------------------------|--------------------------|---|
| L              | R              |              | L                        | R                        |   |
| AIM-157-IW50-L | AIM-157-IW50-R | 1500x700x920 | <input type="checkbox"/> | <input type="checkbox"/> | - |

### TEKNİK DETAYLAR / TECHNICAL DETAILS

TR

- Paslanmaz Çelik AISI 304'ten üretilmiştir.
- Üst tabla kalınlığı 1.2 mm'dir.
- Eyye boyutları [BxExY]: 400x400x300 mm.
- Boşluk ebatı: 600x628x825.
- Çarpma kapaklıdır.
- MDF ile güçlendirilmiş, ses geçirmez çalışma yüzeyi bulunur.
- Ayak kısımları opsiyonel olarak baza ile kapatılabilir.
- Standart 10 cm sırtlıklıdır.

EN

- Brushed structure stainless steel AISI 304
- Top plate thickness is 1.2 mm.
- Sink dimensions [BxExY]: 400x400x300 mm.
- Space Size: 600x628x825.
- Hinged doors.
- Soundproof work surface reinforced with MDF.
- Foot parts can be optionally covered with plinth.
- Standard 10 cm backslash.

### TEKNİK ÇİZİM / TECHNICAL DRAWING

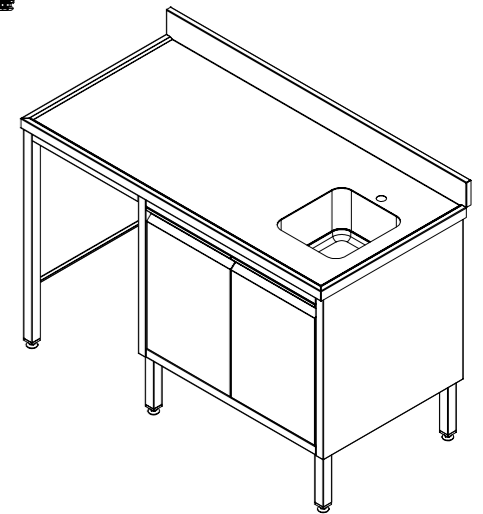
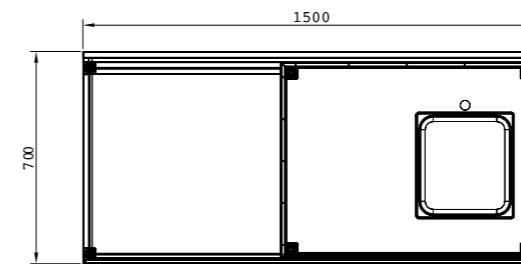
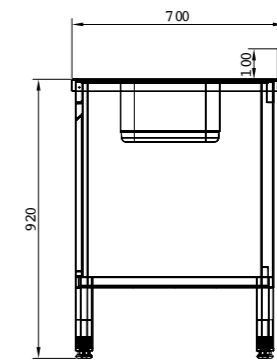
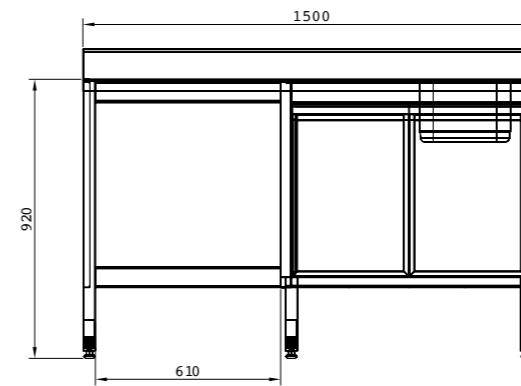





# MODÜLER KAHVE BAR TEZGAHLARI MODULAR CAFE BAR COUNTERS

BAR TEZGAHI - DEVRİLİR ÇÖP ÇEKMECELİ VE SIYIRMA HUNİLİ  
BAR COUNTER W/TILTING DRAWER & GARBAGE HOLE

NEW  
PRODUCT



| KOD CODE     |              | <br>(MM) | DRAWER SIDE   |  | € |
|--------------|--------------|---|---|--|---|
| L            | R            |   | L   | R  |   |
| AIM-127-GH-L | AIM-127-GH-R | 1200x700x920  |  |  | - |
| AIM-157-GH-L | AIM-157-GH-R | 1500x700x920  |  |  | - |

## TEKNİK DETAYLAR / TECHNICAL DETAILS

TR

- Paslanmaz Çelik AISI 304'ten üretilmiştir.
- Üst tabla kalınlığı 1.2 mm'dir.
- Çöp arabası için boşluklu.
- Çarpma kapaklıdır.
- MDF ile güçlendirilmiş, ses geçirmez çalışma yüzeyi bulunur.
- Ayak kısımları opsiyonel olarak baza ile kapatılabilir.
- Standart 10 cm sırtlıklıdır.

EN

- Brushed structure stainless steel AISI 304
- Top plate thickness is 1.2 mm.
- With space for waste bin.
- Hinged doors.
- Soundproof work surface reinforced with MDF.
- Foot parts can be optionally covered with plinth.
- Standard 10 cm backsplash.

## TEKNİK ÇİZİM / TECHNICAL DRAWING

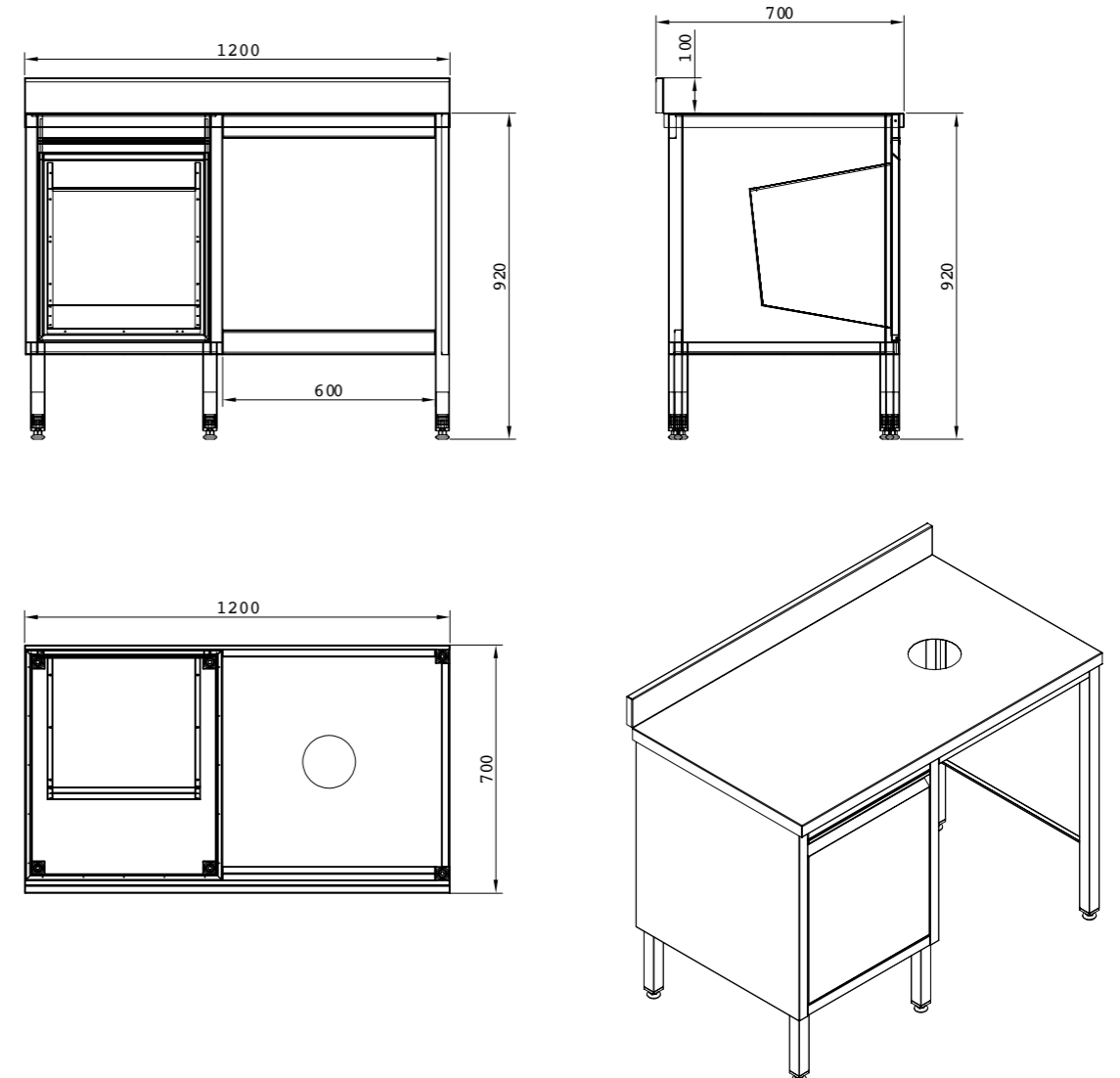



# MODÜLER KAHVE BAR TEZGAHLARI MODULAR CAFE BAR COUNTERS

KOKTEYL HAZIRLIK ÜNİTESİ & SPEED RAIL  
COCKTAIL PREPARATION UNIT & SPEED RAIL

NEW  
PRODUCT



KOKTEYL HAZIRLIK ÜNİTESİ & SPEED RAIL  
COCKTAIL PREPARATION UNIT & SPEED RAIL

NEW  
PRODUCT



## TEKNİK DETAYLAR / TECHNICAL DETAILS

TR

- Paslanmaz Çelik AISI 304'ten üretilmiştir.
- Ice chest ve 16x1/9 gn küvet haznesi ile donatılmıştır.
- Taban raflıdır.
- MDF ile güçlendirilmiş, ses geçirmez çalışma yüzeyi bulunur.
- Ayak kısımları opsiyonel olarak baza ile kapatılabilir.
- Standart 10 cm sırtlıklardır.

EN

- Brushed structure stainless steel AISI 304
- Equipped with ice chest and 16x1/9 gn cuvette.
- With bottom shelf.
- Soundproof work surface reinforced with MDF.
- Foot parts can be optionally covered with plinth.
- Standard 10 cm backplash.

| KOD CODE        | (MM)         | € |
|-----------------|--------------|---|
| AIM-127-COC-SPD | 1200x700x920 | - |
| AIM-147-COC-SPD | 1400x700x920 | - |

## TEKNİK DETAYLAR / TECHNICAL DETAILS

TR

- Paslanmaz Çelik AISI 304'ten üretilmiştir.
- Ice chest ve 4x1/9 gn küvet haznesi ile donatılmıştır.
- Taban raflıdır.
- MDF ile güçlendirilmiş, ses geçirmez çalışma yüzeyi bulunur.
- Ayak kısımları opsiyonel olarak baza ile kapatılabilir.
- Standart 10 cm sırtlıklardır.

EN

- Brushed structure stainless steel AISI 304
- Equipped with ice chest and 4x1/9 gn cuvette.
- With bottom shelf.
- Soundproof work surface reinforced with MDF.
- Foot parts can be optionally covered with plinth.
- Standard 10 cm backplash.

| KOD CODE       | (MM)        | € |
|----------------|-------------|---|
| AIM-87-COC-SPD | 800x700x920 | - |

# MODÜLER KAHVE BAR TEZGAHLARI

## MODULAR CAFE BAR COUNTERS

ŞİŞELİK STANDI / BAR TEZGAHI - EYELİ  
SPEED RAIL STANT / BAR COUNTER W/SINK

NEW  
PRODUCT

47-SPD



57-COC-I



57-COC-S-SPD



### TEKNİK DETAYLAR / TECHNICAL DETAILS

TR

- Paslanmaz Çelik AISI 304'ten üretilmiştir.
- Taban rafıdır.
- MDF ile güçlendirilmiş, ses geçirmez çalışma yüzeyi bulunur.
- Ayak kısımları opsiyonel olarak baza ile kapatılabilir.
- Standart 10 cm sırtlıklıdır.
- Üst tabla kalınlığı 1.2 mm'dir.
- Eveye boyutları (BxExY): 400x400x300 mm.
- AIM-57-COC; buz küvetlidir.
- AIM-57-COC-S-SPD; speed rail ve taban rafıdır.
- MDF ile güçlendirilmiş, ses geçirmez çalışma yüzeyi bulunur.
- Ayak kısımları opsiyonel olarak baza ile kapatılabilir.
- Standart 10 cm sırtlıklıdır.

EN

- Brushed structure stainless steel AISI 304
- With bottom shelf.
- Soundproof work surface reinforced with MDF.
- Foot parts can be optionally covered with plinth.
- Standard 10 cm backplash.
- Top plate thickness is 1.2 mm.
- Sink dimensions (BxExY): 400x400x300 mm.
- AIM-57-COC with ice tub.
- AIM-57-COC-S-SPD with speed rail and bottom shelf.
- Soundproof work surface reinforced with MDF.
- Foot parts can be optionally covered with plinth.
- Standard 10 cm backplash.

| KOD CODE      | (MM)        | € |
|---------------|-------------|---|
| AIM-47-SPD    | 400x700x920 | - |
| AIM-COC-I     | 500x700x920 | - |
| AIM-COC-S-SPD | 500x700x920 | - |

# MODÜLER KAHVE BAR TEZGAHLARI

## MODULAR CAFE BAR COUNTERS

AKSESUARLAR  
ACCESSORIES

NEW  
PRODUCT

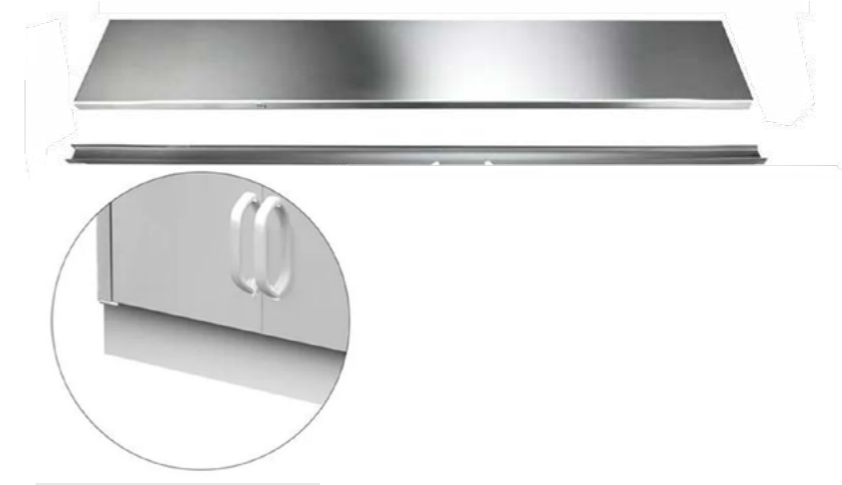

PASLANMAZ ÇELİK BAZA  
STAINLESS STEEL PLINTH

| KOD CODE  | (MM) | € |
|-----------|------|---|
| AIM P-40  | 400  | - |
| AIM P-50  | 500  | - |
| AIM P-80  | 800  | - |
| AIM P-90  | 900  | - |
| AIM P-100 | 1000 | - |
| AIM P-110 | 1100 | - |
| AIM P-120 | 1200 | - |
| AIM P-140 | 1400 | - |
| AIM P-150 | 1500 | - |
| AIM P-160 | 1600 | - |
| AIM P-210 | 2100 | - |
| AIM P-290 | 2900 | - |

PASLANMAZ GİDER TABLASI  
STAINLESS STEEL DRAINBOARD

| KOD CODE   | (MM) | € |
|------------|------|---|
| AIM DR-120 | 1200 | - |

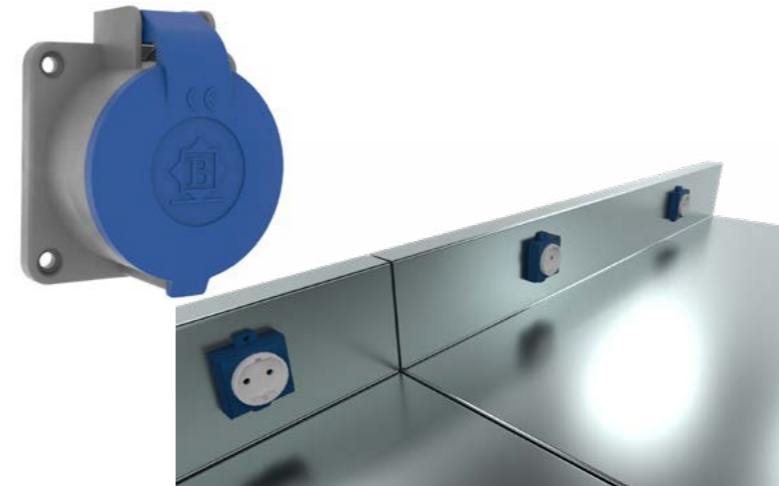

16 AMPER PRİZ  
16 AMP. SOCKET

| KOD CODE | € |
|----------|---|
| AIM PR01 | - |

Priz kullanımı için sırtlıkların min. 150 mm olması gerekmektedir.  
For socket use, backplash must be at least 150 mm.

# INOX SERVIS EKİPMANLARI



# INOX SERVICE EQUIPMENT



ÇALIŞMA TEZGAHLARI - DEMONTE  
WORK TABLE - FLAT PACKED

WTF



WTF-S



WTF-A



WTF-SA



TEKNİK DETAYLAR / TECHNICAL DETAILS

TR

- Paslanmaz Çelik AISI 430'dan üretilmiştir
- Kolay kurulma imkanı
- Yuvarlatılmış köşeler
- Alt rafsız
- Yüksekliği ayarlanabilir
- Kare profil 40 x 40 mm
- MDF ile güçlendirilmiş çalışma yüzeyi (ses geçirmez)
- Tek / Çift / Üçlü Çekmece montaj imkanı
- Sırtlıklı modellerde 10cm sırtlık

EN

- Brushed Structure Stainless Steel AISI 430
- Self Assembly
- Rounded corners
- Without Undershelf
- Adjustable in height
- Square profile 40 x 40 mm
- Working surface reinforced with MDF (sound proof)
- Single / Double / Tripple Drawers mounting possibility
- 10cm Backsplash models on WTF-S models

| KOD CODE    |             | [ MM ]       |              | €      |        |
|-------------|-------------|--------------|--------------|--------|--------|
| 600 MM      | 700 MM      | 600 MM       | 700 MM       | 600 MM | 700 MM |
| WTF-706085  | WTF-707085  | 700x600x850  | 700x700x850  | -      | -      |
| WTF-806085  | WTF-807085  | 800x600x850  | 800x700x850  | -      | -      |
| WTF-906085  | WTF-907085  | 900x600x850  | 900x700x850  | -      | -      |
| WTF-1006085 | WTF-1007085 | 1000x600x850 | 1000x700x850 | -      | -      |
| WTF-1206085 | WTF-1207085 | 1200x600x850 | 1200x700x850 | -      | -      |
| WTF-1406085 | WTF-1407085 | 1400x600x850 | 1400x700x850 | -      | -      |
| WTF-1506085 | WTF-1507085 | 1500x600x850 | 1500x700x850 | -      | -      |
| WTF-1606085 | WTF-1607085 | 1600x600x850 | 1600x700x850 | -      | -      |
| WTF-1806085 | WTF-1807085 | 1800x600x850 | 1800x700x850 | -      | -      |
| WTF-2006085 | WTF-2007085 | 2000x600x850 | 2000x700x850 | -      | -      |

| KOD CODE      |               | [ MM ]       |              | €      |        |
|---------------|---------------|--------------|--------------|--------|--------|
| 600 MM        | 700 MM        | 600 MM       | 700 MM       | 600 MM | 700 MM |
| WTF-706085-S  | WTF-707085-S  | 700x600x850  | 700x700x850  | -      | -      |
| WTF-806085-S  | WTF-807085-S  | 800x600x850  | 800x700x850  | -      | -      |
| WTF-906085-S  | WTF-907085-S  | 900x600x850  | 900x700x850  | -      | -      |
| WTF-1006085-S | WTF-1007085-S | 1000x600x850 | 1000x700x850 | -      | -      |
| WTF-1206085-S | WTF-1207085-S | 1200x600x850 | 1200x700x850 | -      | -      |
| WTF-1406085-S | WTF-1407085-S | 1400x600x850 | 1400x700x850 | -      | -      |
| WTF-1506085-S | WTF-1507085-S | 1500x600x850 | 1500x700x850 | -      | -      |
| WTF-1606085-S | WTF-1607085-S | 1600x600x850 | 1600x700x850 | -      | -      |
| WTF-1806085-S | WTF-1807085-S | 1800x600x850 | 1800x700x850 | -      | -      |
| WTF-2006085-S | WTF-2007085-S | 2000x600x850 | 2000x700x850 | -      | -      |

ÇALIŞMA TEZGAHLARI - ALT RAFLI - DEMONTE  
WORK TABLE - W/U - FLAT PACKED

TEKNİK DETAYLAR / TECHNICAL DETAILS

TR

- Paslanmaz Çelik AISI 430'dan üretilmiştir
- Kolay kurulma imkanı
- Yuvarlatılmış köşeler
- Alt raflı
- Yüksekliği ayarlanabilir
- Kare profil 40 x 40 mm
- MDF ile güçlendirilmiş çalışma yüzeyi (ses geçirmez)
- Tek / Çift / Üçlü Çekmece montaj imkanı
- Sırtlıklı modellerde 10cm sırtlık

EN

- Brushed Structure Stainless Steel AISI 430
- Self Assembly
- Rounded corners
- With Undershelf
- Adjustable in height
- Square profile 40 x 40 mm
- Working surface reinforced with MDF (sound proof)
- Single / Double / Tripple Drawers mounting possibility
- 10cm Backsplash models on WTF-SA models

| KOD CODE      |               | [ MM ]       |              | €      |        |
|---------------|---------------|--------------|--------------|--------|--------|
| 600 MM        | 700 MM        | 600 MM       | 700 MM       | 600 MM | 700 MM |
| WTF-706085-A  | WTF-707085-A  | 700x600x850  | 700x700x850  | -      | -      |
| WTF-806085-A  | WTF-807085-A  | 800x600x850  | 800x700x850  | -      | -      |
| WTF-906085-A  | WTF-907085-A  | 900x600x850  | 900x700x850  | -      | -      |
| WTF-1006085-A | WTF-1007085-A | 1000x600x850 | 1000x700x850 | -      | -      |
| WTF-1206085-A | WTF-1207085-A | 1200x600x850 | 1200x700x850 | -      | -      |
| WTF-1406085-A | WTF-1407085-A | 1400x600x850 | 1400x700x850 | -      | -      |
| WTF-1506085-A | WTF-1507085-A | 1500x600x850 | 1500x700x850 | -      | -      |
| WTF-1606085-A | WTF-1607085-A | 1600x600x850 | 1600x700x850 | -      | -      |
| WTF-1806085-A | WTF-1807085-A | 1800x600x850 | 1800x700x850 | -      | -      |
| WTF-2006085-A | WTF-2007085-A | 2000x600x850 | 2000x700x850 | -      | -      |

| KOD CODE       |                | [ MM ]       |              | €      |        |
|----------------|----------------|--------------|--------------|--------|--------|
| 600 MM         | 700 MM         | 600 MM       | 700 MM       | 600 MM | 700 MM |
| WTF-706085-SA  | WTF-707085-SA  | 700x600x850  | 700x700x850  | -      | -      |
| WTF-806085-SA  | WTF-807085-SA  | 800x600x850  | 800x700x850  | -      | -      |
| WTF-906085-SA  | WTF-907085-SA  | 900x600x850  | 900x700x850  | -      | -      |
| WTF-1006085-SA | WTF-1007085-SA | 1000x600x850 | 1000x700x850 | -      | -      |
| WTF-1206085-SA | WTF-1207085-SA | 1200x600x850 | 1200x700x850 | -      | -      |
| WTF-1406085-SA | WTF-1407085-SA | 1400x600x850 | 1400x700x850 | -      | -      |
| WTF-1506085-SA | WTF-1507085-SA | 1500x600x850 | 1500x700x850 | -      | -      |
| WTF-1606085-SA | WTF-1607085-SA | 1600x600x850 | 1600x700x850 | -      | -      |
| WTF-1806085-SA | WTF-1807085-SA | 1800x600x850 | 1800x700x850 | -      | -      |
| WTF-2006085-SA | WTF-2007085-SA | 2000x600x850 | 2000x700x850 | -      | -      |

ÇALIŞMA TEZGAHLARI - ALT VE ARA RAFLI - DEMONTE  
WORK TABLE - W/U&W/M - FLAT PACKED

WTF-2A



WTF-S2A

BLOK ÇEKMECELER - TEZGAHA MONTE  
BLOCK DRAWER - FOR UNDER WORK TABLE

BD

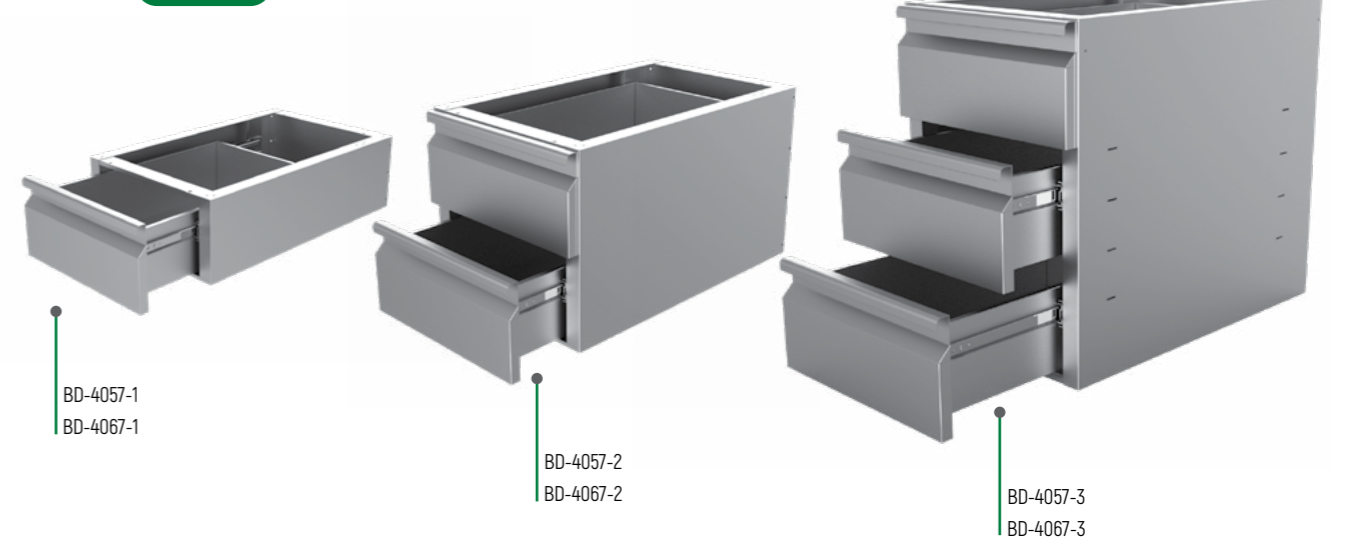

## TEKNİK DETAYLAR / TECHNICAL DETAILS

## TR

- Paslanmaz Çelik AISI 430'dan üretilmiştir
- Kolay kurulma imkanı
- Yuvarlatılmış köşeler
- Taban ve ara rafı
- Yüksekliği ayarlanabilir
- Kare profil 40 x 40 mm
- MDF ile güçlendirilmiş çalışma yüzeyi (ses geçirmez)
- Tek / Çift / Üçlü Çekmece montaj imkanı
- Sırtlıklı modellerde 10cm sırtlık

## EN

- Brushed Structure Stainless Steel AISI 430
- Rounded corners
- With Undershell + Center Shelf
- Adjustable in height
- Square profile 40 x 40 mm
- Working surface reinforced with MDF (sound proof)
- Single / Double / Tripple Drawers mounting possibility
- 10cm Backsplash models on WTF-S2A models

| KOD CODE       |                | ( MM )       |              | €      |        |
|----------------|----------------|--------------|--------------|--------|--------|
| 600 MM         | 700 MM         | 600 MM       | 700 MM       | 600 MM | 700 MM |
| WTF-706085-2A  | WTF-707085-2A  | 700x600x850  | 700x700x850  | -      | -      |
| WTF-806085-2A  | WTF-807085-2A  | 800x600x850  | 800x700x850  | -      | -      |
| WTF-906085-2A  | WTF-907085-2A  | 900x600x850  | 900x700x850  | -      | -      |
| WTF-1006085-2A | WTF-1007085-2A | 1000x600x850 | 1000x700x850 | -      | -      |
| WTF-1206085-2A | WTF-1207085-2A | 1200x600x850 | 1200x700x850 | -      | -      |
| WTF-1406085-2A | WTF-1407085-2A | 1400x600x850 | 1400x700x850 | -      | -      |
| WTF-1506085-2A | WTF-1507085-2A | 1500x600x850 | 1500x700x850 | -      | -      |
| WTF-1606085-2A | WTF-1607085-2A | 1600x600x850 | 1600x700x850 | -      | -      |
| WTF-1806085-2A | WTF-1807085-2A | 1800x600x850 | 1800x700x850 | -      | -      |
| WTF-2006085-2A | WTF-2007085-2A | 2000x600x850 | 2000x700x850 | -      | -      |

## TEKNİK DETAYLAR / TECHNICAL DETAILS

## TR

- Paslanmaz Çelik AISI 430'dan üretilmiştir
- 600/700 serisine uygun blok çekmece
- Yavaş açma / kapama
- Kolay kurulum

## EN

- Made of brushed stainless steel AISI 430
- Block drawer suitable for 600/700 series
- Soft open / close
- Easy construction

| KOD CODE  |           | ( MM )  |         | €      |        |
|-----------|-----------|---------|---------|--------|--------|
| 600 MM    | 700 MM    | 600 MM  | 700 MM  | 600 MM | 700 MM |
| BD-4057-1 | BD-4067-1 | 400x570 | 400x670 | -      | -      |
| BD-4057-2 | BD-4067-2 | 400x570 | 400x670 | -      | -      |
| BD-4057-3 | BD-4067-3 | 400x570 | 400x670 | -      | -      |

BD seri blok çekmeceler tezgaha monte olarak kullanılmaktadır.  
BD line block drawers can be used only with work tables.

ÇALIŞMA TEZGAHLARI - ALT RAFLI - DEMONTE  
WORK TABLE - W/U - FLAT PACKED

WTF-WO

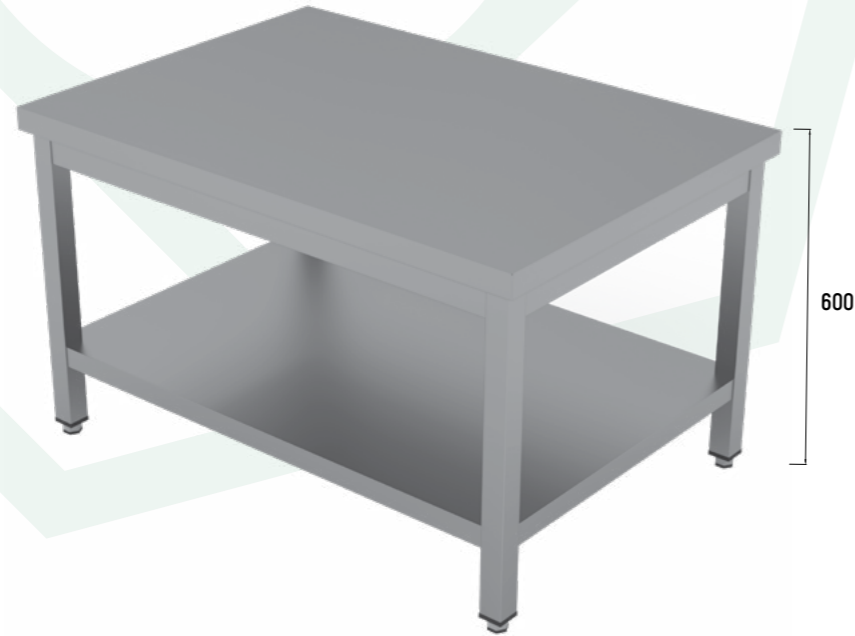
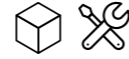

600

ÇALIŞMA TEZGAHLARI - SÜRGÜ KAPAKLI  
WORK TABLE - SLIDING DOORS

WT-S

WT-SS



## TEKNİK DETAYLAR / TECHNICAL DETAILS

TR

- Paslanmaz Çelik AISI 430'dan üretilmiştir
- Alt raflı
- Yüksekliği ayarlanabilir
- Kare profil 40 x 40 mm
- MDF ile güçlendirilmiş çalışma yüzeyi (ses geçirmez)

EN

- Brushed Structure Stainless Steel AISI 430
- With Undershelf
- Adjustable in height
- Square profile 40 x 40 mm
- Working surface reinforced with MDF (sound proof)

| KOD CODE       |              | €      |
|----------------|--------------|--------|
| 700 MM         | 700 MM       | 700 MM |
| WTF-1007060-WO | 1000x700x600 | -      |
| WTF-1207060-WO | 1200x700x600 | -      |
| WTF-1407060-WO | 1400x700x600 | -      |
| WTF-1607060-WO | 1600x700x600 | -      |
| WTF-1807060-WO | 1800x700x600 | -      |
| WTF-2007060-WO | 2000x700x600 | -      |

## TEKNİK DETAYLAR / TECHNICAL DETAILS

TR

- Paslanmaz Çelik AISI 430'dan üretilmiştir
- MDF ile güçlendirilmiş çalışma yüzeyi (ses geçirmez)
- Entegre kulplu sürgülü kapılar
- Yüksekliği ayarlanabilen paslanmaz çelik ayaklar
- Sırtlıklı modellerde 10cm sırtlık

EN

- Brushed structure stainless steel AISI 430
- Working surface reinforced with MDF (sound proof)
- Sliding doors with integrated handle
- Stainless steel legs adjustable in height
- 10cm Backsplash models on WTF-SS models

| KOD CODE     |              |              | €            |
|--------------|--------------|--------------|--------------|
| 600 MM       | 700 MM       | 600 MM       | 700 MM       |
| WT-1006085-S | WT-1007085-S | 1000x600x850 | 1000x700x850 |
| WT-1206085-S | WT-1207085-S | 1200x600x850 | 1200x700x850 |
| WT-1406085-S | WT-1407085-S | 1400x600x850 | 1400x700x850 |
| WT-1506085-S | WT-1507085-S | 1500x600x850 | 1500x700x850 |
| WT-1606085-S | WT-1607085-S | 1600x600x850 | 1600x700x850 |
| WT-1806085-S | WT-1807085-S | 1800x600x850 | 1800x700x850 |
| WT-2006085-S | WT-2007085-S | 2000x600x850 | 2000x700x850 |

| KOD CODE      |               |              | €            |
|---------------|---------------|--------------|--------------|
| 600 MM        | 700 MM        | 600 MM       | 700 MM       |
| WT-1006085-SS | WT-1007085-SS | 1000x600x850 | 1000x700x850 |
| WT-1206085-SS | WT-1207085-SS | 1200x600x850 | 1200x700x850 |
| WT-1406085-SS | WT-1407085-SS | 1400x600x850 | 1400x700x850 |
| WT-1506085-SS | WT-1507085-SS | 1500x600x850 | 1500x700x850 |
| WT-1606085-SS | WT-1607085-SS | 1600x600x850 | 1600x700x850 |
| WT-1806085-SS | WT-1807085-SS | 1800x600x850 | 1800x700x850 |
| WT-2006085-SS | WT-2007085-SS | 2000x600x850 | 2000x700x850 |

Kapaklar çift cidarlıdır.  
Doors are double skin.

WT-2S



WT-H-2S



WT-H



WT-SH



## TEKNİK DETAYLAR / TECHNICAL DETAILS

## TR

- Paslanmaz Çelik AISI 430'dan üretilmiştir
- Wok için özel üretim
- Alt Rafı
- Yüksekliği ayarlanabilir
- MDF ile güçlendirilmiş çalışma yüzeyi (ses geçirmez)
- Sıcaklık aralığı: +30 / + 80 °C. (WT-H-2S)
- Elektrik gücü: 230V / 1N 50-60Hz (WT-H-2S)
- Kw: 1,5 (WT-H-2S)

## EN

- Brushed Structure Stainless Steel AISI 430
- Special production for the Wok
- With Undershelf
- Adjustable in height
- Working surface reinforced with MDF (sound proof)
- Temperature range: +30 / + 80 °C. (WT-H-2S)
- Electrical power: 230V / 1N 50-60Hz (WT-H-2S)
- Kw: 1.5 (WT-H-2S)

| KOD CODE      |               | [ MM ]       | €            |        |       |
|---------------|---------------|--------------|--------------|--------|-------|
| 600 MM        | 700 MM        |              | 600 MM       | 700 MM |       |
| WT-1006085-2S | WT-1007085-2S | 1000x600x850 | 1000x700x850 | 945    | 998   |
| WT-1206085-2S | WT-1207085-2S | 1200x600x850 | 1200x700x850 | 968    | 1.020 |
| WT-1406085-2S | WT-1407085-2S | 1400x600x850 | 1400x700x850 | 1.058  | 1.114 |
| WT-1506085-2S | WT-1507085-2S | 1500x600x850 | 1500x700x850 | 1.065  | 1.122 |
| WT-1606085-2S | WT-1607085-2S | 1600x600x850 | 1600x700x850 | 1.144  | 1.212 |
| WT-1806085-2S | WT-1807085-2S | 1800x600x850 | 1800x700x850 | 1.178  | 1.242 |
| WT-2006085-2S | WT-2007085-2S | 2000x600x850 | 2000x700x850 | 1.313  | 1.388 |

| KOD CODE        |              | [ MM ] | €      |        |
|-----------------|--------------|--------|--------|--------|
| 700 MM          | 700 MM       |        | 700 MM | 700 MM |
| WT-1007085-H-2S | 1000x700x850 | -      | -      |        |
| WT-1207085-H-2S | 1200x700x850 | -      | -      |        |
| WT-1407085-H-2S | 1400x700x850 | -      | -      |        |
| WT-1507085-H-2S | 1500x700x850 | -      | -      |        |
| WT-1607085-H-2S | 1600x700x850 | -      | -      |        |
| WT-1807085-H-2S | 1800x700x850 | -      | -      |        |
| WT-2007085-H-2S | 2000x700x850 | -      | -      |        |

Kapaklar çift cidarlıdır.  
Doors are double skin.

## TEKNİK DETAYLAR / TECHNICAL DETAILS

## TR

- Paslanmaz Çelik AISI 430'dan üretilmiştir
- Tezgah güçlendirilmiş ve ses emici izolasyonla donatılmıştır.
- Termal sıcaklık kontrolü
- Sıcaklık aralığı: +30 / + 80 °C.
- Entegre kulplu sürgülü kapılar
- Yüksekliği ayarlanabilen paslanmaz çelik ayaklar
- Elektrik gücü: 230V / 1N 50-60Hz
- Kw: 1,5

## EN

- Brushed structure stainless steel AISI 430
- Worktop reinforced and fitted with sound-absorbing isolation.
- Thermal temperature control
- Temperature range: +30 / + 80 °C.
- Sliding doors with integrated handle
- Stainless steel legs adjustable in height
- Electrical power: 230V / 1N 50-60Hz
- Kw: 1.5

| KOD CODE     |              | [ MM ]       | €            |        |   |
|--------------|--------------|--------------|--------------|--------|---|
| 600 MM       | 700 MM       |              | 600 MM       | 700 MM |   |
| WT-1006085-H | WT-1007085-H | 1000x600x850 | 1000x700x850 | -      | - |
| WT-1206085-H | WT-1207085-H | 1200x600x850 | 1200x700x850 | -      | - |
| WT-1406085-H | WT-1407085-H | 1400x600x850 | 1400x700x850 | -      | - |
| WT-1506085-H | WT-1507085-H | 1500x600x850 | 1500x700x850 | -      | - |
| WT-1606085-H | WT-1607085-H | 1600x600x850 | 1600x700x850 | -      | - |
| WT-1806085-H | WT-1807085-H | 1800x600x850 | 1800x700x850 | -      | - |
| WT-2006085-H | WT-2007085-H | 2000x600x850 | 2000x700x850 | -      | - |

| KOD CODE      |               | [ MM ]       | €            |        |   |
|---------------|---------------|--------------|--------------|--------|---|
| 600 MM        | 700 MM        |              | 600 MM       | 700 MM |   |
| WT-1006085-SH | WT-1007085-SH | 1000x600x850 | 1000x700x850 | -      | - |
| WT-1206085-SH | WT-1207085-SH | 1200x600x850 | 1200x700x850 | -      | - |
| WT-1406085-SH | WT-1407085-SH | 1400x600x850 | 1400x700x850 | -      | - |
| WT-1506085-SH | WT-1507085-SH | 1500x600x850 | 1500x700x850 | -      | - |
| WT-1606085-SH | WT-1607085-SH | 1600x600x850 | 1600x700x850 | -      | - |
| WT-1806085-SH | WT-1807085-SH | 1800x600x850 | 1800x700x850 | -      | - |
| WT-2006085-SH | WT-2007085-SH | 2000x600x850 | 2000x700x850 | -      | - |

Kapaklar çift cidarlıdır.  
Doors are double skin.

ÇALIŞMA TEZGAHLARI - BLOK ÇEKMECELİ - SÜRGÜ KAPAKLI  
WORK TABLE - BLOCK DRAWERS - SLIDING DOOR

WTS -L / -R

WTS -SL / -SR

ÇALIŞMA TEZGAHLARI - BLOK ÇEKMECELİ - SÜRGÜ KAPAKLI  
WORK TABLE - BLOCK DRAWERS - SLIDING DOOR

WTS-RL

WTS-RLS



## TEKNİK DETAYLAR / TECHNICAL DETAILS

TR

- Paslanmaz Çelik AISI 430'dan üretilmiştir
- MDF ile güçlendirilmiş çalışma yüzeyi (ses geçirmez)
- Entegre kulplu sürgülü kapılar
- 3 çekmeceli
- Yüksekliği ayarlanabilen paslanmaz çelik ayaklar
- Sırtlıklı modellerde 10cm sırtlık

EN

- Brushed structure stainless steel AISI 430
- Working surface reinforced with MDF (sound proof)
- Sliding doors with integrated handle
- With 3 drawers
- Stainless steel legs adjustable in height
- 10cm Backsplash models on WTF-SL/-SR models

| KOD CODE      |               | ↑<br>[ MM ]<br>↓ | €            |       |   |
|---------------|---------------|------------------|--------------|-------|---|
| 700 L         | 700 R         |                  | 700 L        | 700 R |   |
| WTS-1407085-L | WTS-1407085-R | 1400x700x850     | 1400x700x850 | -     | - |
| WTS-1607085-L | WTS-1607085-R | 1600x700x850     | 1600x700x850 | -     | - |
| WTS-1807085-L | WTS-1807085-R | 1800x700x850     | 1800x700x850 | -     | - |
| WTS-2007085-L | WTS-2007085-R | 2000x700x850     | 2000x700x850 | -     | - |

| KOD CODE       |                | ↑<br>[ MM ]<br>↓ | €            |        |   |
|----------------|----------------|------------------|--------------|--------|---|
| 700 SL         | 700 SR         |                  | 700 SL       | 700 SR |   |
| WTS-1407085-SL | WTS-1407085-SR | 1400x700x850     | 1400x700x850 | -      | - |
| WTS-1607085-SL | WTS-1607085-SR | 1600x700x850     | 1600x700x850 | -      | - |
| WTS-1807085-SL | WTS-1807085-SR | 1800x700x850     | 1800x700x850 | -      | - |
| WTS-2007085-SL | WTS-2007085-SR | 2000x700x850     | 2000x700x850 | -      | - |

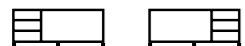

## TEKNİK DETAYLAR / TECHNICAL DETAILS

TR

- Paslanmaz Çelik AISI 430'dan üretilmiştir
- MDF ile güçlendirilmiş çalışma yüzeyi (ses geçirmez)
- 3 + 3 çekmeceli sol & sağ 1/1 GN
- Ortada entegre kulplu sürgülü kapılar
- Yüksekliği ayarlanabilen paslanmaz çelik ayaklar
- Sırtlıklı modellerde 10cm sırtlık

EN

- Brushed structure stainless steel AISI 430
- Working surface reinforced with MDF (sound proof)
- With 3 + 3 drawers left & right 1/1 GN
- Sliding doors in middle with integrated handle
- Stainless steel legs adjustable in height
- 10cm Backsplash models on WTS-RLS models

| KOD CODE       | ↑<br>[ MM ]<br>↓ | €      |
|----------------|------------------|--------|
| 700 MM         |                  | 700 MM |
| WTS-1807085-RL | 1800x700x850     | -      |
| WTS-2007085-RL | 2000x700x850     | -      |
| WTS-2407085-RL | 2400x700x850     | -      |

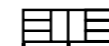

| KOD CODE        | ↑<br>[ MM ]<br>↓ | €      |
|-----------------|------------------|--------|
| 700 MM          |                  | 700 MM |
| WTS-1807085-RLS | 1800x700x850     | -      |
| WTS-2007085-RLS | 2000x700x850     | -      |
| WTS-2407085-RLS | 2400x700x850     | -      |

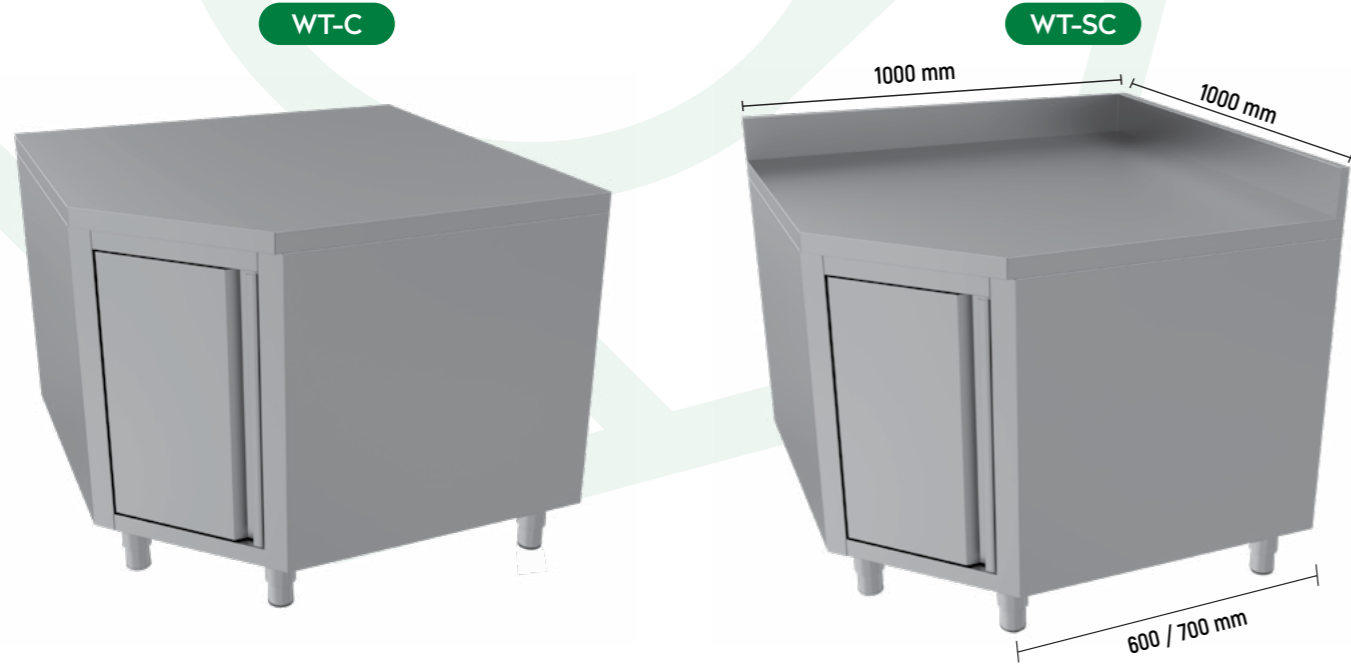

ÇALIŞMA TEZGAHLARI - KÖŞE MODEL  
WORK TABLE - CORNER TYPEÇALIŞMA TEZGAHLARI - BLOK ÇEKMECELİ  
WORK TABLE - BLOCK DRAWER

## TEKNİK DETAYLAR / TECHNICAL DETAILS

## TR

- Paslanmaz Çelik AISI 430'dan üretilmiştir
- MDF ile güçlendirilmiş çalışma yüzeyi (ses geçirmez)
- 600 ve 700 serisi çalışma tezgahları için kullanılabilir
- Sağlam yapı
- Orta rafı
- Yumuşak açma/kapama mekanizmalı kapı
- Yüksekliği ayarlanabilen paslanmaz çelik ayaklar
- Sırtlıklı modellerde 10cm sırtlık

## EN

- Brushed structure stainless steel AISI 430
- Working surface reinforced with MDF (sound proof)
- Usable for the 600 & 700 serie worktables
- Robust construction
- With center shelf
- Door with soft open/close mechanism
- Stainless steel legs adjustable in height
- 10cm Backsplash models on WTF-SC models

| KOD CODE        | (MM)          | €       | KOD CODE         | (MM)          | €       |
|-----------------|---------------|---------|------------------|---------------|---------|
| 600-700         | 600-700       | 600-700 | 600-700          | 600-700       | 600-700 |
| WT-10010085-C60 | 1000x1000x850 | -       | WT-10010085-SC60 | 1000x1000x850 | -       |
| WT-10010085-C70 | 1000x1000x850 | -       | WT-10010085-SC70 | 1000x1000x850 | -       |

## TEKNİK DETAYLAR / TECHNICAL DETAILS

## TR

- Paslanmaz Çelik AISI 430'dan üretilmiştir
- MDF ile güçlendirilmiş çalışma yüzeyi (ses geçirmez)
- 3 çekmeceli
- Yüksekliği ayarlanabilen paslanmaz çelik ayaklar
- Sırtlıklı modellerde 10cm sırtlık

## EN

- Brushed structure stainless steel AISI 430
- Working surface reinforced with MDF (sound proof)
- With 3 drawers
- Stainless steel legs adjustable in height
- 10cm Backsplash models on WT-S3D models

| KOD CODE     | (MM)        | € | KOD CODE      | (MM)        | € |
|--------------|-------------|---|---------------|-------------|---|
| WT-507085-3D | 500x700x850 | - | WT-507085-S3D | 500x700x850 | - |

ÇALIŞMA TEZGAHLARI - PİZZA MAYALANDIRMA ÇEKMECELİ  
WORK TABLE - PIZZA FERMENTATION DRAWER

DR-6

DR-6S

ÇALIŞMA TEZGAHLARI - 6 ÇEKMECELİ  
WORK TABLE - 6 DRAWERS

WT-6D

WT-S6D



## TEKNİK DETAYLAR / TECHNICAL DETAILS

TR

- Paslanmaz Çelik AISI 430'dan üretilmiştir
- Ayaklı / 6S modeli
- MDF ile güçlendirilmiş çalışma yüzeyi (ses geçirmez)
- Pizza hamur kutuları için 6 çekmeceli (600x400mm) 100MM
- Yüksekliği ayarlanabilen paslanmaz çelik ayaklar

EN

- Brushed structure stainless steel AISI 430
- With upstand / 6S model
- Working surface reinforced with MDF (sound proof)
- With 6 drawers for Pizza dough boxes (600x400mm) 100MM
- Stainless steel legs adjustable in height

| KOD CODE | (MM)        | € | KOD CODE | (MM)        | € |
|----------|-------------|---|----------|-------------|---|
| DR-6     | 600x700x850 | - | DR-6S    | 600x700x850 | - |

## TEKNİK DETAYLAR / TECHNICAL DETAILS

TR

- Paslanmaz Çelik AISI 430'dan üretilmiştir
- MDF ile güçlendirilmiş çalışma yüzeyi (ses geçirmez)
- 6 çekmeceli
- Yüksekliği ayarlanabilen paslanmaz çelik ayaklar
- Sırtlıklı modellerde 10cm sırtlık

EN

- Brushed structure stainless steel AISI 430
- Working surface reinforced with MDF (sound proof)
- With 6 drawers
- Stainless steel legs adjustable in height
- 10cm Backsplash models on WT-S3D models

| KOD CODE     | (MM)         | € | KOD CODE       | (MM)         | € |
|--------------|--------------|---|----------------|--------------|---|
| WT-1007085-6 | 1000x700x850 | - | WT-1007085-S6D | 1000x700x850 | - |

CK



## TEKNİK DETAYLAR / TECHNICAL DETAILS

TR

- Paslanmaz Çelik AISI 430'dan üretilmiştir
- Entegre kulplu açılır kapaklı kapılar
- Yüksekliği ayarlanabilen paslanmaz çelik ayaklar

EN

- Brushed structure stainless steel AISI 430
- Hinged doors with integrated handle
- Stainless steel legs adjustable in height

| KOD CODE  |        | ↑<br>↓<br>(MM) |             | €      |        |
|-----------|--------|----------------|-------------|--------|--------|
| 600 MM    | 700 MM | 600 MM         | 700 MM      | 600 MM | 700 MM |
| CK-500-60 | CK-500 | 500x600x850    | 500x700x850 | -      | -      |
| CK-600-60 | CK-600 | 600x600x850    | 600x700x850 | -      | -      |
| CK-700-60 | CK-700 | 700x600x850    | 700x700x850 | -      | -      |
| CK-800-60 | CK-800 | 800x600x850    | 800x700x850 | -      | -      |
| CK-900-60 | CK-900 | 900x600x850    | 900x700x850 | -      | -      |

CK-S

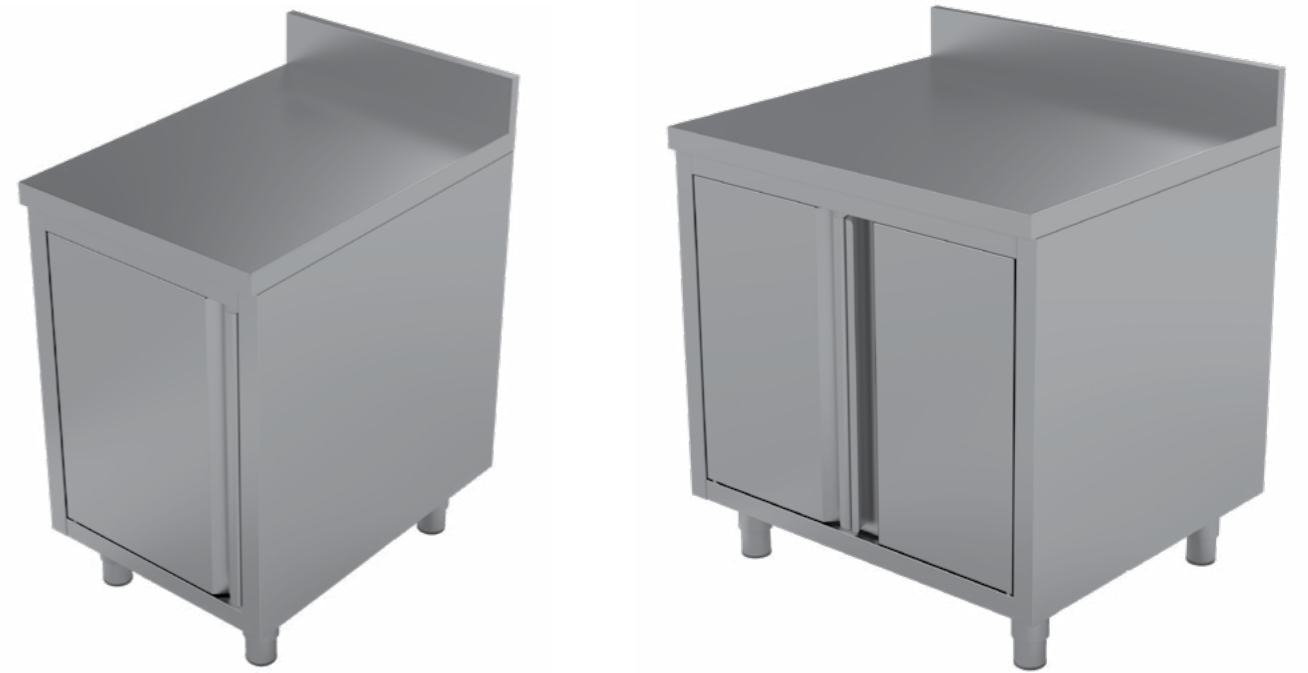

## TEKNİK DETAYLAR / TECHNICAL DETAILS

TR

- Paslanmaz Çelik AISI 430'dan üretilmiştir
- MDF ile güçlendirilmiş çalışma yüzeyi (ses geçirmez)
- Entegre kulplu açılır kapaklı kapılar
- Yüksekliği ayarlanabilen paslanmaz çelik ayaklar
- Sırtlıklı modellerde 10cm sırtlık

EN

- Brushed structure stainless steel AISI 430
- Working surface reinforced with MDF (sound proof)
- Hinged doors with integrated handle
- Stainless steel legs adjustable in height
- 10cm Backsplash models on CK-S models

| KOD CODE    |          | ↑<br>↓<br>(MM) |             | €      |        |
|-------------|----------|----------------|-------------|--------|--------|
| 600 MM      | 700 MM   | 600 MM         | 700 MM      | 600 MM | 700 MM |
| CK-500-60-S | CK-500-S | 500x600x850    | 500x700x850 | -      | -      |
| CK-600-60-S | CK-600-S | 600x600x850    | 600x700x850 | -      | -      |
| CK-700-60-S | CK-700-S | 700x600x850    | 700x700x850 | -      | -      |
| CK-800-60-S | CK-800-S | 800x600x850    | 800x700x850 | -      | -      |
| CK-900-60-S | CK-900-S | 900x600x850    | 900x700x850 | -      | -      |

POLİETİLEN ÇALIŞMA TEZGAHI - ÇEKMECELİ SÜRGÜLÜ KAPILAR  
POLYETHYLENE WORKTABLE - SLIDING DOORS WITH DRAWERS

WTFC

POLİETİLEN ÇALIŞMA TEZGAHI - SÜRGÜLÜ KAPILAR  
POLYETHYLENE WORKTABLE - WITH SLIDING DOORS

WTFS



## TEKNİK DETAYLAR / TECHNICAL DETAILS

TR

- Kırmızı renk
- Yuvarlatılmış köşeler
- İdeal çalışma yüksekliği
- Çok yüksek yük kapasitesi
- Alt ve ara raf
- Yavaş kapanan/açılan kapı sistemi
- Temizlemesi kolay
- Kesme plakası kalınlığı: 40 mm
- MDF Omega ile güçlendirilmiş tezgah
- Çift cidarlı paslanmaz çelik tezgah

EN

- Red colour in standart production
- Rounded corners
- Ideal working height
- Very high load capacity
- Bottom and intermediate shelf
- Soft close/open system of door
- Easy to clean
- Cutting plate thickness: 40 mm
- Worktop reinforced with MDF Omega
- Double-walled stainless steel worktop

| KOD CODE       |                | [ MM ]       |              | €      |        |
|----------------|----------------|--------------|--------------|--------|--------|
| 700 SL         | 700 SR         | 700 SL       | 700 SR       | 700 SL | 700 SR |
| WTFC-1407085SL | WTFC-1407085SR | 1400x700x850 | 1400x700x850 | -      | -      |
| WTFC-1607085SL | WTFC-1607085SR | 1600x700x850 | 1600x700x850 | -      | -      |
| WTFC-1807085SL | WTFC-1807085SR | 1800x700x850 | 1800x700x850 | -      | -      |
| WTFC-2007085SL | WTFC-2007085SR | 2000x700x850 | 2000x700x850 | -      | -      |



## TEKNİK DETAYLAR / TECHNICAL DETAILS

TR

- Kırmızı renk
- Yuvarlatılmış köşeler
- İdeal çalışma yüksekliği
- Çok yüksek yük kapasitesi
- Alt ve ara raf
- Yavaş kapanan/açılan kapı sistemi
- Temizlemesi kolay
- Kesme plakası kalınlığı: 40 mm
- MDF Omega ile güçlendirilmiş tezgah
- Çift cidarlı paslanmaz çelik tezgah

EN

- Red colour in standart production
- Rounded corners
- Ideal working height
- Very high load capacity
- Bottom and intermediate shelf
- Soft close/open system of door
- Easy to clean
- Cutting plate thickness: 40 mm
- Worktop reinforced with MDF Omega
- Double-walled stainless steel worktop

| KOD CODE     |              | [ MM ]       |              | €      |        |
|--------------|--------------|--------------|--------------|--------|--------|
| 600 MM       | 700 MM       | 600 MM       | 700 MM       | 600 MM | 700 MM |
| WTFS-1006085 | WTFS-1007085 | 1000x600x850 | 1000x700x850 | -      | -      |
| WTFS-1206085 | WTFS-1207085 | 1200x600x850 | 1200x700x850 | -      | -      |
| WTFS-1406085 | WTFS-1407085 | 1400x600x850 | 1400x700x850 | -      | -      |
| WTFS-1506085 | WTFS-1507085 | 1500x600x850 | 1500x700x850 | -      | -      |
| WTFS-1606085 | WTFS-1607085 | 1600x600x850 | 1600x700x850 | -      | -      |
| WTFS-1806085 | WTFS-1807085 | 1800x600x850 | 1800x700x850 | -      | -      |
| WTFS-2006085 | WTFS-2007085 | 2000x600x850 | 2000x700x850 | -      | -      |

POLİETİLEN ÇALIŞMA TEZGAHI - ALT RAF (KAYNAKLI)  
POLYETHYLENE WORKTABLE - BOTTOM SHELF (WELDED)

WTFP



## TEKNİK DETAYLAR / TECHNICAL DETAILS

TR

- Kırmızı renk
- Yuvarlatılmış köşeler
- İdeal çalışma yüksekliği
- Çok yüksek yük kapasitesi
- Alt raf
- Temizlemesi kolay
- Kesme plakası kalınlığı: 40 mm
- MDF Omega ile güçlendirilmiş tezgah
- Çift cidarlı paslanmaz çelik tezgah

EN

- Red colour in standart production
- Rounded corners
- Ideal working height
- Very high load capacity
- Bottom shelf
- Easy to clean
- Cutting plate thickness: 40 mm
- Worktop reinforced with MDF Omega
- Double-walled stainless steel worktop

| KOD CODE     |              | [ MM ]       |              | €      |        |
|--------------|--------------|--------------|--------------|--------|--------|
| 600 MM       | 700 MM       | 600 MM       | 700 MM       | 600 MM | 700 MM |
| WTFP-100608  | WTFP-100708  | 1000x600x850 | 1000x700x850 | -      | -      |
| WTFP-1206085 | WTFP-1207085 | 1200x600x850 | 1200x700x850 | -      | -      |
| WTFP-1406085 | WTFP-1407085 | 1400x600x850 | 1400x700x850 | -      | -      |
| WTFP-1506085 | WTFP-1507085 | 1500x600x850 | 1500x700x850 | -      | -      |
| WTFP-1606085 | WTFP-1607085 | 1600x600x850 | 1600x700x850 | -      | -      |
| WTFP-1806085 | WTFP-1807085 | 1800x600x850 | 1800x700x850 | -      | -      |
| WTFP-2006085 | WTFP-2007085 | 2000x600x850 | 2000x700x850 | -      | -      |

POLİETİLEN - ET KÜTÜĞÜ  
POLYETHYLENE - CHOPPING BLOCK

CB



## TEKNİK DETAYLAR / TECHNICAL DETAILS

TR

- Kırmızı renk
- Yuvarlatılmış köşeler
- İdeal çalışma yüksekliği
- Çok yüksek yük kapasitesi
- Temizlemesi kolay
- Kesme plakası kalınlığı: 100 mm

EN

- Red colour in standart production
- Rounded corners
- Ideal working height
- Very high load capacity
- Easy to clean
- Cutting plate thickness: 100 mm

| KOD CODE | [ MM ]      | € |
|----------|-------------|---|
| CB4004   | 400x400x850 | - |
| CB5006   | 500x600x850 | - |
| CB8006   | 800x600x850 | - |
| CB4007   | 700x700x850 | - |
| CB8008   | 800x800x850 | - |

WA-S



WA

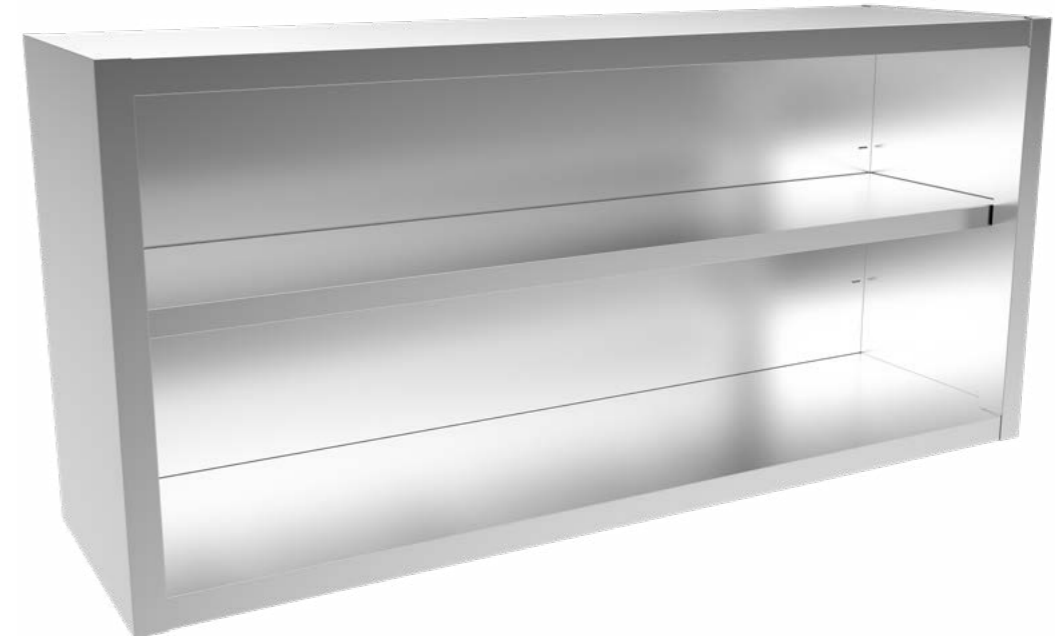

## TEKNİK DETAYLAR / TECHNICAL DETAILS

TR

- Paslanmaz Çelik AISI 430'dan üretilmiştir
- Kaynaklı yapı
- Entegre kulplu sürgülü kapılar
- 25 kg yük kapasitesi
- Orta raf içerir

EN

- Brushed structure stainless steel AISI 430
- Welded construction
- Sliding doors with integrated handle
- 25 KG load capacity
- Including middle shelf

| KOD CODE     | <br>(MM) | €      |
|--------------|---|--------|
| 400 MM       | 400 MM  | 400 MM |
| WA-1004066-S | 1000x400x660  | -      |
| WA-1204066-S | 1200x400x660  | -      |
| WA-1404066-S | 1400x400x660  | -      |
| WA-1504066-S | 1500x400x660  | -      |
| WA-1604066-S | 1600x400x660  | -      |
| WA-1804066-S | 1800x400x660  | -      |
| WA-2004066-S | 2000x400x660  | -      |

## TEKNİK DETAYLAR / TECHNICAL DETAILS

TR

- Paslanmaz Çelik AISI 430'dan üretilmiştir
- Kaynaklı yapı
- Açık sürüm
- 25 kg yük kapasitesi
- Orta raf içerir

EN

- Brushed structure stainless steel AISI 430
- Welded construction
- Open version
- 25KG load capacity
- Including middle shelf

| KOD CODE   | <br>(MM) | €      |
|------------|---|--------|
| 400 MM     | 400 MM  | 400 MM |
| WA-1004066 | 1000x400x660  | -      |
| WA-1204066 | 1200x400x660  | -      |
| WA-1404066 | 1400x400x660  | -      |
| WA-1504066 | 1500x400x660  | -      |
| WA-1604066 | 1600x400x660  | -      |
| WA-1804066 | 1800x400x660  | -      |
| WA-2004066 | 2000x400x660  | -      |

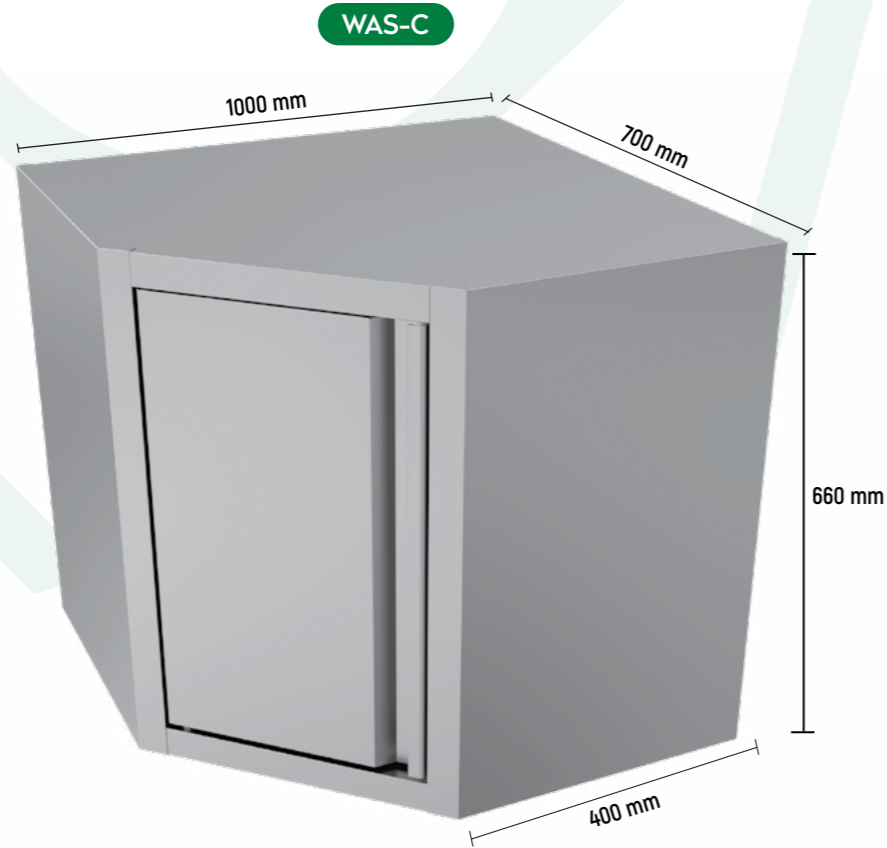
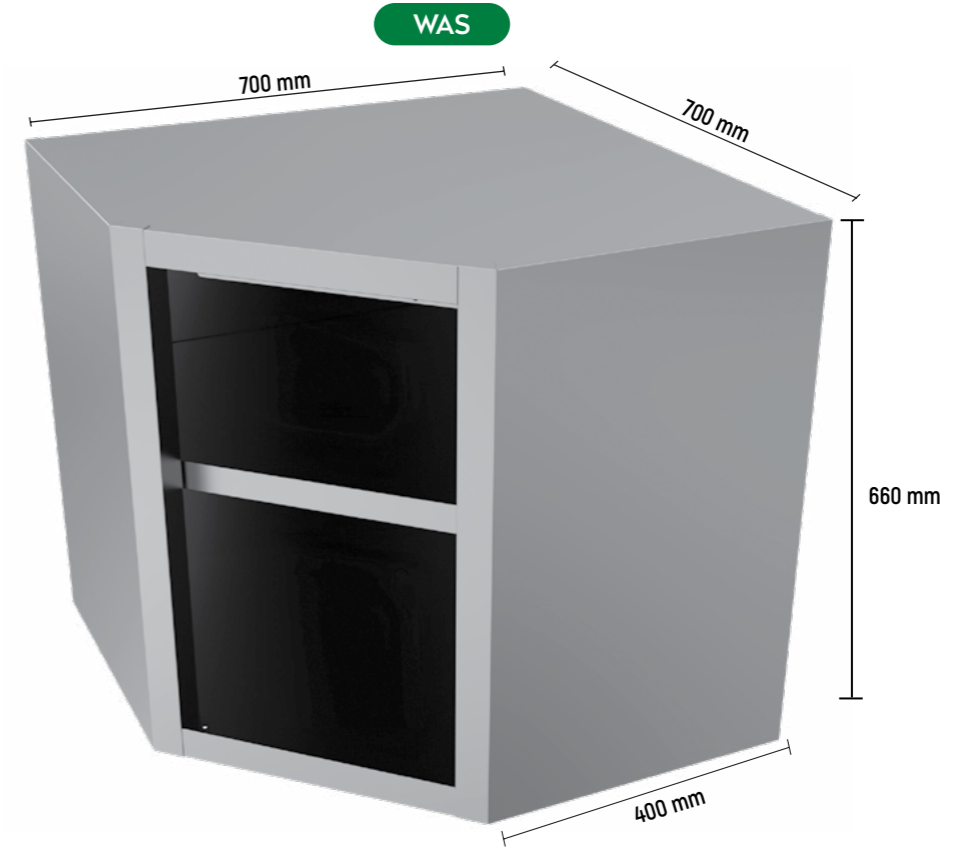
DUVAR DOLAPLARI - ÇARPMA KAPAKLI  
WALL CUPBOARD - HINGED DOORSDUVAR DOLAPLARI - KAPAKSIZ  
WALL CUPBOARD - OPEN DOOR

## TEKNİK DETAYLAR / TECHNICAL DETAILS

## TR

- Paslanmaz Çelik AISI 430'dan üretilmiştir
- Kaynaklı yapı
- Yumuşak açma/kapama mekanizmalı kapı
- 90°
- Orta raf içerir
- WA tipi dolaplarla kullanılabilir

## EN

- Brushed structure stainless steel AISI 430
- Welded construction
- Door with soft open/close mechanism
- 90°
- Including middel shelf
- Usable with WA -type cupboards

| KOD CODE     | <br>(MM) | €      |
|--------------|---|--------|
| 700 MM       | 700 MM  | 700 MM |
| WAS-707066-C | 700x700x660   | -      |

## TEKNİK DETAYLAR / TECHNICAL DETAILS

## TR

- Paslanmaz Çelik AISI 430'dan üretilmiştir
- Kaynaklı yapı
- Açık sürüm
- 25 kg yük kapasitesi
- Orta raf içerir

## EN

- Brushed structure stainless steel AISI 430
- Welded construction
- Open version
- Including middel shelf
- Usable with WA -type cupboards

| KOD CODE   | <br>(MM) | €      |
|------------|---|--------|
| 700 MM     | 700 MM  | 700 MM |
| WAS-707066 | 700x700x660   | -      |

ET-A

ET-2A

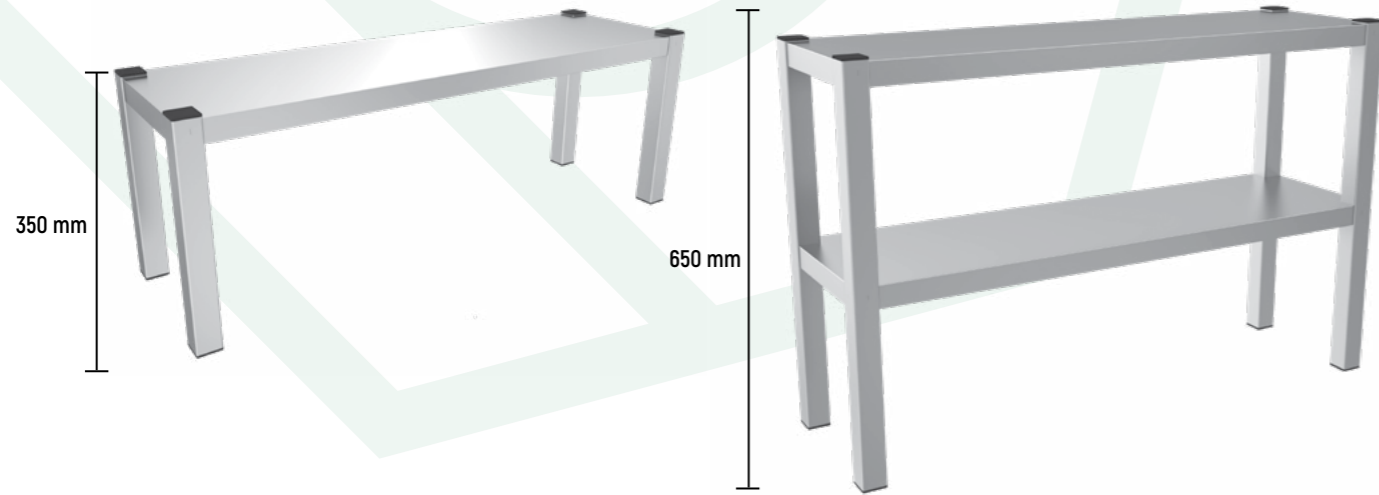
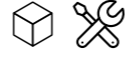

ET-HH

ET-SH

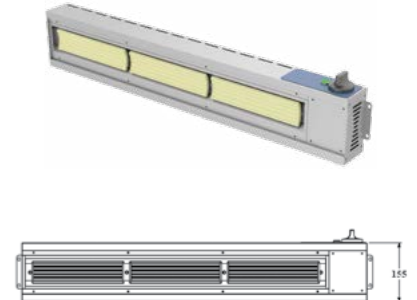
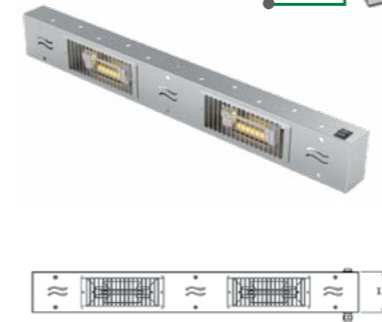

HALOGEN

CERAMIC

## TEKNİK DETAYLAR / TECHNICAL DETAILS

TR

- Paslanmaz Çelik AISI 430'dan üretilmiştir
- Kolay kurulum imkanı
- Yüksek yükleme kapasitesi
- SH veya HH seri ısıtmalı ısıtıcı takılabilir

EN

- Made of brushed stainless steel AISI 430
- Self Assembly
- High loading capacity
- Can be fitted with the SH or HH serieheated warmer

## TEKNİK DETAYLAR / TECHNICAL DETAILS

TR

- Paslanmaz Çelik AISI 430'dan üretilmiştir
- Halojen veya seramik ısıtma elemanı
- Mükemmel ısı dağılımı
- Kolay kurulum
- Açma kapama anahtarı 230V
- ET modelleri ile kullanılabilir

EN

- Made of brushed stainless steel AISI 430
- Halogeen or ceramic warming element
- Excellent heat distribution
- Handy installation
- On off switch 230V
- Usable with the ET models

| KOD CODE     |               |          | € |    |
|--------------|---------------|----------|---|----|
| A            | 2A            |          | A | 2A |
| ET-1003035-A | ET-1003035-2A | 1000x300 | - | -  |
| ET-1203035-A | ET-1203035-2A | 1200x300 | - | -  |
| ET-1403035-A | ET-1403035-2A | 1400x300 | - | -  |
| ET-1603035-A | ET-1603035-2A | 1600x300 | - | -  |
| ET-1803035-A | ET-1803035-2A | 1800x300 | - | -  |
| ET-2003035-A | ET-2003035-2A | 2000x300 | - | -  |

| KOD CODE  |           |          | €  |    |
|-----------|-----------|----------|----|----|
| HH        | SH        |          | HH | SH |
| ET-100-HH | ET-100-SH | 1000x300 | -  | -  |
| ET-120-HH | ET-120-SH | 1200x300 | -  | -  |
| ET-140-HH | ET-140-SH | 1400x300 | -  | -  |
| ET-160-HH | ET-160-SH | 1600x300 | -  | -  |
| ET-180-HH | ET-180-SH | 1800x300 | -  | -  |
| ET-200-HH | ET-200-SH | 2000x300 | -  | -  |

PATATES DİNLENDİRME RAFI  
CHIPS SCUTTLE

DT

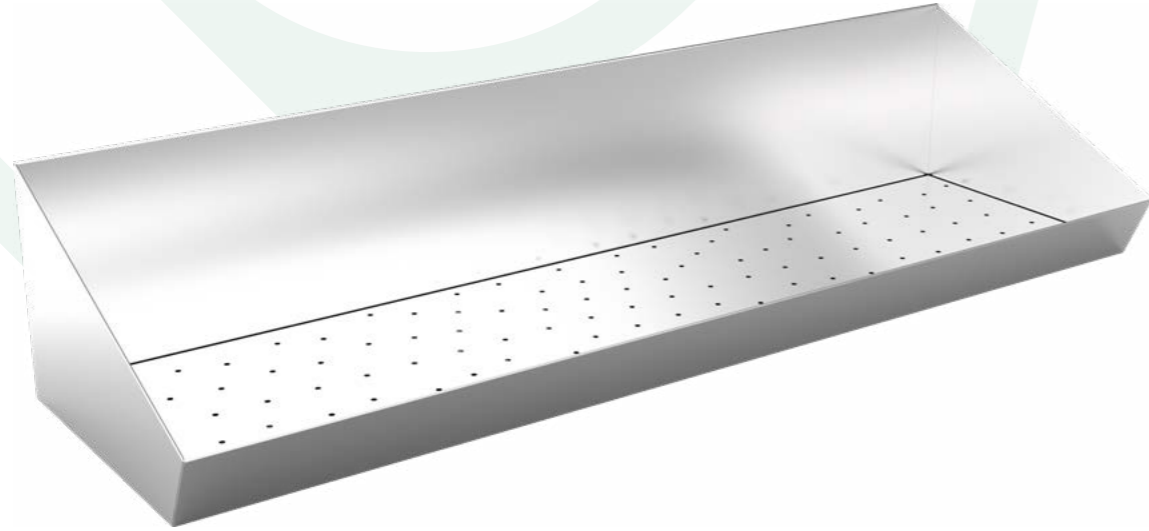

## TEKNİK DETAYLAR / TECHNICAL DETAILS

TR

- Paslanmaz Çelik AISI 430'dan üretilmiştir
- Kaynaklı yapı
- Duvar askılı aksesuar ile

EN

- Brushed structure stainless steel AISI 430
- Welded construction
- Accesory with wall bracket

| KOD CODE | (MM)         | € |
|----------|--------------|---|
| DT-60    | 600x300x200  | - |
| DT-70    | 700x300x200  | - |
| DT-80    | 800x300x200  | - |
| DT-90    | 900x300x200  | - |
| DT-100   | 1000x300x200 | - |
| DT-120   | 1200x300x200 | - |
| DT-140   | 1400x300x200 | - |
| DT-150   | 1500x300x200 | - |

DUVAR RAFI - DEMONTE  
WALLSHELF - FLAT PACKED

## TEKNİK DETAYLAR / TECHNICAL DETAILS

TR

- Paslanmaz Çelik AISI 430'dan üretilmiştir
- Duvar konsolu içerir
- Çeşitli yüksekliklerde ayarlanabilir
- Kat başına 35 kg'a kadar yük kapasitesi

EN

- Brushed structure stainless steel AISI 430
- Includes wall console
- Adjustable in several heights
- Load capacity up to 35 kg per floor

| 300<br>KOD CODE |               |                | (MM)     | €    |       |       |
|-----------------|---------------|----------------|----------|------|-------|-------|
| WS-A            | WS-2A         | WS-3A          | (MM)     | WS-A | WS-2A | WS-3A |
| WS-803036-A     | WS-803070-2A  | WS-8030100-3A  | 800x300  | -    | -     | -     |
| WS-1003036-A    | WS-1003070-2A | WS-10030100-3A | 1000x300 | -    | -     | -     |
| WS-1203036-A    | WS-1203070-2A | WS-12030100-3A | 1200x300 | -    | -     | -     |
| WS-1403036-A    | WS-1403070-2A | WS-14030100-3A | 1400x300 | -    | -     | -     |
| WS-1603036-A    | WS-1603070-2A | WS-16030100-3A | 1600x300 | -    | -     | -     |
| WS-1803036-A    | WS-1803070-2A | WS-18030100-3A | 1800x300 | -    | -     | -     |
| WS-2003036-A    | WS-2003070-2A | WS-20030100-3A | 2000x300 | -    | -     | -     |

DİK DOLAPLAR  
PAN CUPBOARD

PC

FIRIN ALT STANDI  
STAND FOR OVEN

CS



## TEKNİK DETAYLAR / TECHNICAL DETAILS

TR

- Paslanmaz Çelik AISI 430'dan üretilmiştir
- Sağlam çıkarılabilir raflar
- Raf yüksekliği ayarlanabilir
- Paslanmaz çelik ayarlanabilir ayaklar
- Sürgülü kapılar
- Sürgülü kapılar için entegre kulp

EN

- Brushed structure stainless steel AISI 430
- Sturdy removable shelves
- Shelves height adjustable
- Stainless steel adjustable feet
- Sliding doors
- Integrated handle for sliding doors

| KOD CODE    | (MM)          | € |
|-------------|---------------|---|
| PC-12060180 | 1200x600x1800 | - |
| PC-16060180 | 1600x600x1800 | - |

## TEKNİK DETAYLAR / TECHNICAL DETAILS

TR

- Paslanmaz çelik AISI 430
- Kaynaklı yapı
- Kombi buharlı fırın için özel sağlam tasarım
- Kapasite 8 x 1/1GN (325x530mm)
- Farklı yüksekliklerde ayarlanabilir ayaklar
- Yüksek taşıma kapasitesi

EN

- Stainless steel AISI 430
- Welded construction
- Special robust design for combi steamer
- Capacity 8 x 1/1GN (325x530mm)
- Adjustable feet in different heights
- High load-bearing capacity

| KOD CODE | (MM)        | € |
|----------|-------------|---|
| CS-700   | 900x800x700 | - |
| CS-900   | 900x800x900 | - |



## EVYELİ ÇALIŞMA TEZGAHI - ÇARPMA KAPAK SINK WITH HINGED DOORS

SCK







### TEKNİK DETAYLAR / TECHNICAL DETAILS

TR

- Entegre kulplu sürgülü kapılar
- Ayaklı
- AISI 304 üst tabla
- Evye boyutları mm cinsinden (BxExY):500x500x300
- Yüksekliği ayarlanabilen paslanmaz çelik ayaklar

EN

- Hinged doors with integrated handle
- With upstand
- AISI 304 top
- Bowl dimensions in mm (BxDxH): 500x500x300
- Stainless steel legs adjustable in height

| KOD CODE  | <br>(MM) | SINK SIDE   | € |
|-----------|---|---|---|
| SCK-60-70 | 600x700x850   |  | - |
| SCK-70-70 | 700x700x850   |  | - |
| SCK-80-70 | 800x700x850   |  | - |

LAVABO - DÜZ PAKETLİ  
SINK - FLAT PACKED

STF-L/-R

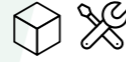
EVYELİ TEZGAHLAR - SÜRGÜ KAPAKLI  
SINK WITH SLIDING DOORS

ST-LS/-RS



## TEKNİK DETAYLAR / TECHNICAL DETAILS

TR

- AISI 304 üst tabla
- Ayaklı
- Evye boyutları mm [BxExY]: 500x500x300
- Yüksekliği ayarlanabilen paslanmaz çelik ayaklar

EN

- AISI 304 top
- With upstand
- Bowl dimensions in mm [BxDxH]: 500x500x300
- Stainless steel legs adjustable in height

| KOD CODE       | [MM]         | SINK SIDE | € |
|----------------|--------------|-----------|---|
| STF-607085-1   | 600x700x850  |           | - |
| STF-707085-1   | 700x700x850  |           | - |
| STF-807085-1   | 800x700x850  |           | - |
| KOD CODE       | [MM]         | SINK SIDE | € |
| STF-2007085-2M | 2000x700x850 |           | - |

| KOD CODE        |                 | [MM]         | SINK SIDE |       | € |
|-----------------|-----------------|--------------|-----------|-------|---|
| 700-L           | 700-R           |              | 700-L     | 700-R |   |
| STF-1007085-1 L | STF-1007085-1 R | 1000x700x850 |           |       | - |
| STF-1207085-1 L | STF-1207085-1 R | 1200x700x850 |           |       | - |
| STF-1407085-1 L | STF-1407085-1 R | 1400x700x850 |           |       | - |
| STF-1607085-2 L | STF-1607085-2 R | 1600x700x850 |           |       | - |
| STF-1807085-2 L | STF-1807085-2 R | 1800x700x850 |           |       | - |
| STF-2007085-2 L | STF-2007085-2 R | 2000x700x850 |           |       | - |

## TEKNİK DETAYLAR / TECHNICAL DETAILS

TR

- Entegre kulplu sürgülü kapılar
- Ayaklı
- AISI 304 üst tabla
- Evye mm cinsinden [BxExY]:500x500x300
- Yüksekliği ayarlanabilen paslanmaz çelik ayaklar

EN

- Sliding doors with integrated handle
- With upstand
- AISI 304 top
- Bowl dimensions in mm [Bx DxH]:500x500x300
- Stainless steel legs adjustable in height

| KOD CODE       | [MM]         | SINK SIDE | € |
|----------------|--------------|-----------|---|
| ST-2007085-2MS | 2000x700x850 |           | - |

| KOD CODE       |                | [MM]         | SINK SIDE |       | € |
|----------------|----------------|--------------|-----------|-------|---|
| 700-L          | 700-R          |              | 700-L     | 700-R |   |
| ST-1007085-1LS | ST-1007085-1RS | 1000x700x850 |           |       | - |
| ST-1207085-1LS | ST-1207085-1RS | 1200x700x850 |           |       | - |
| ST-1407085-1LS | ST-1407085-1RS | 1400x700x850 |           |       | - |
| ST-1607085-2LS | ST-1607085-2RS | 1600x700x850 |           |       | - |
| ST-1807085-2LS | ST-1807085-2RS | 1800x700x850 |           |       | - |
| ST-2007085-2LS | ST-2007085-2RS | 2000x700x850 |           |       | - |

EYELİ ÇALIŞMA TEZGAHI SÜRGÜ KAPAKLI - BYM BOŞLUKLU  
SINK WITH SLIDING DOORS AND SPACE FOR DISHWASHER

SWS

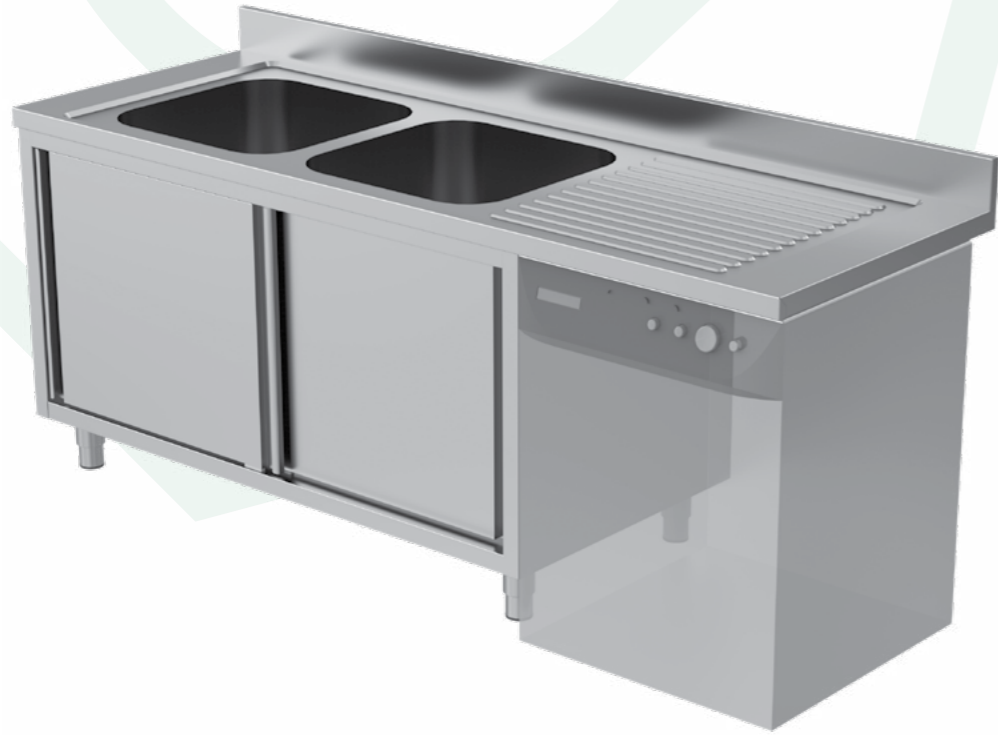
EYELİ ÇALIŞMA TEZGAHI - KAYNAKLI  
SINK WITH DISHWASHER SPACE - WELDED

SWF



## TEKNİK DETAYLAR / TECHNICAL DETAILS

TR

- Entegre kulplu sürgülü kapılar
- Bulaşık makinesi için yer ile
- AISI 304 üst tabla
- Ayaklı
- Eyeye boyutları mm (BxExY): 500x500x300
- Yüksekliği ayarlanabilen paslanmaz çelik ayaklar

EN

- Sliding doors with integrated handle
- With space for Dishwasher
- AISI 304 top
- With upstand
- Bowl dimensions in mm (BxDxH): 500x500x300
- Stainless steel legs adjustable in height

| KOD CODE        |                 | [MM]         | SINK SIDE |       | € |
|-----------------|-----------------|--------------|-----------|-------|---|
| 700-L           | 700-R           |              | 700-L     | 700-R |   |
| SWS-1207085-1LS | SWS-1207085-1RS | 1200x700x850 |           |       | - |
| SWS-1407085-1LS | SWS-1407085-1RS | 1400x700x850 |           |       | - |
| SWS-1607085-2LS | SWS-1607085-2RS | 1600x700x850 |           |       | - |
| SWS-1807085-2LS | SWS-1807085-2RS | 1800x700x850 |           |       | - |
| SWS-2007085-2LS | SWS-2007085-2RS | 2000x700x850 |           |       | - |

## TEKNİK DETAYLAR / TECHNICAL DETAILS

TR

- Kendinliğinden Kurulum
- Bulaşık makinesi için yer ile Raf Altı ve Ayaklı
- AISI 304 üst tabla
- Eyeye boyutları mm (BxExY): 500x500x300
- Yüksekliği ayarlanabilir
- Kare profil 40 x 40 mm

EN

- With space for Dishwasher
- With undershelf & Upstand
- AISI 304 top
- Bowl dimensions in mm (BxDxH): 500x500x300
- Adjustable in height
- Square profile 40 x 40 mm

| KOD CODE        |                 | [MM]         | SINK SIDE |       | € |
|-----------------|-----------------|--------------|-----------|-------|---|
| 700-L           | 700-R           |              | 700-L     | 700-R |   |
| SWF-1207085-1 L | SWF-1207085-1 R | 1200x700x850 |           |       | - |
| SWF-1407085-1 L | SWF-1407085-1 R | 1400x700x850 |           |       | - |
| SWF-1607085-2 L | SWF-1607085-2 R | 1600x700x850 |           |       | - |
| SWF-1807085-2 L | SWF-1807085-2 R | 1800x700x850 |           |       | - |
| SWF-2007085-2 L | SWF-2007085-2 R | 2000x700x850 |           |       | - |

DAVLUMBAZ  
EXTRACTOR HOOD

EX 700-H

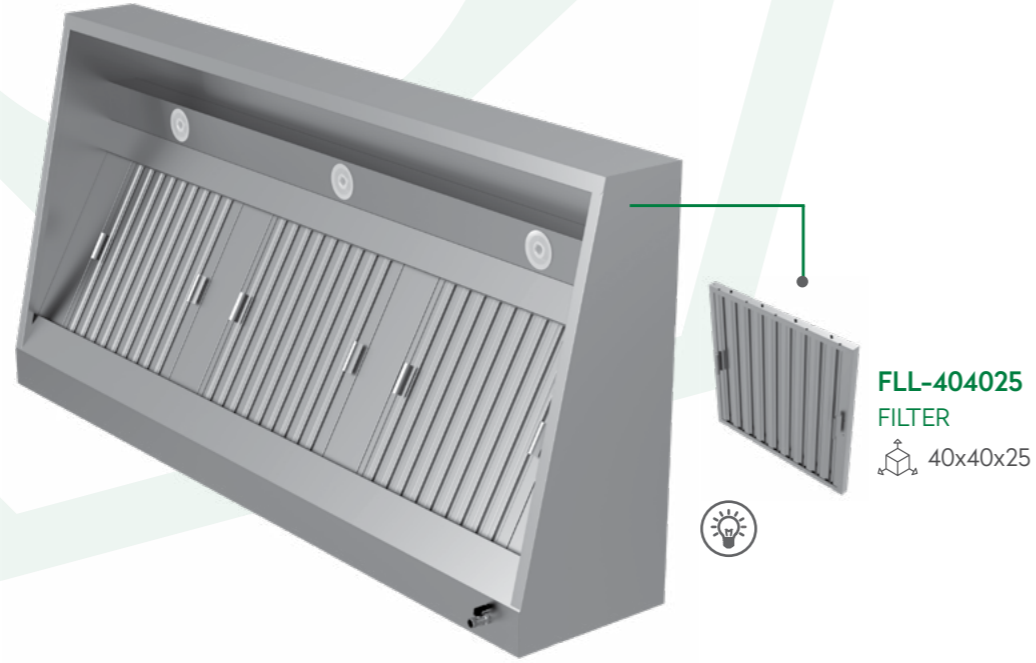
DAVLUMBAZ  
EXTRACTOR HOOD

EX 950-H

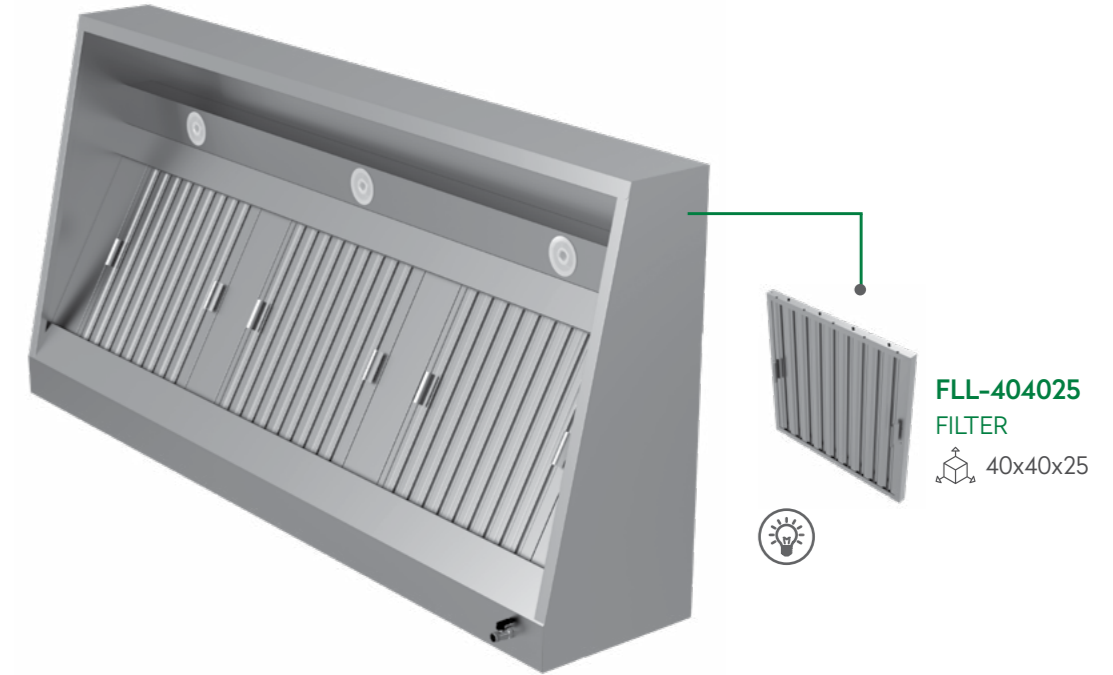

## TEKNİK DETAYLAR / TECHNICAL DETAILS

TR

- Paslanmaz Çelik AISI 430'dan üretilmiştir.
- Davlumbaz eğimlidir ve filtreler 45 derece açıyla monte edilmiştir.
- Dahili standart 5W'lı LED ışık
- Yağ tahliye valfli standart olarak üretilir.
- 400x400mm labirent filtreler dahil

EN

- Brushed structure stainless steel AISI 430
- The hood is slant and the filters are installed with an angle of 45°
- Standard with Led Lightning 5W built-in
- Standard produced with fat drain valve
- Included Labyrinth filters 400x400 mm

| KOD CODE     | (MM)         | LA BYRINT FILTER | LED LIGHTS | € |
|--------------|--------------|------------------|------------|---|
| EX-1007040-H | 1000x700x400 | 2                | 2x5w       | - |
| EX-1207040-H | 1200x700x400 | 2                | 2x5w       | - |
| EX-1407040-H | 1400x700x400 | 2                | 2x5w       | - |
| EX-1507040-H | 1500x700x400 | 3                | 2x5w       | - |
| EX-1607040-H | 1600x700x400 | 3                | 2x5w       | - |
| EX-1807040-H | 1800x700x400 | 3                | 3x5w       | - |
| EX-2007040-H | 2000x700x400 | 3                | 3x5w       | - |
| EX-2207040-H | 2200x700x400 | 4                | 3x5w       | - |
| EX-2407040-H | 2400x700x400 | 4                | 3x5w       | - |
| EX-2507040-H | 2500x700x400 | 4                | 4x5w       | - |
| EX-2607040-H | 2600x700x400 | 4                | 4x5w       | - |
| EX-2807040-H | 2800x700x400 | 5                | 4x5w       | - |
| EX-3007040-H | 3000x700x400 | 5                | 4x5w       | - |
| EX-3207040-H | 3200x700x400 | 6                | 4x5w       | - |
| EX-3407040-H | 3400x700x400 | 6                | 5x5w       | - |
| EX-3507040-H | 3500x700x400 | 6                | 5x5w       | - |
| EX-3607040-H | 3600x700x400 | 7                | 5x5w       | - |
| EX-3807040-H | 3800x700x400 | 7                | 5x5w       | - |
| EX-4007040-H | 4000x700x400 | 7                | 5x5w       | - |

## TEKNİK DETAYLAR / TECHNICAL DETAILS

TR

- Paslanmaz Çelik AISI 430'dan üretilmiştir
- Davlumbaz eğimlidir ve filtreler 45 derece açıyla monte edilmiştir.
- Dahili Standart 5W'lı LED ışık
- Yağ tahliye valfli standart olarak üretilir.
- 495x495 mm labirent filtreler dahil

EN

- Brushed structure stainless steel AISI 430
- The hood is slant and the filters are installed with an angle of 45°
- Standard with Led Lightning 5W built-in
- Standard produced with fat drain valve
- Included Labyrinth filters 495x495 mm

| KOD CODE     | (MM)         | LA BYRINT FILTER | LED LIGHTS | € |
|--------------|--------------|------------------|------------|---|
| EX-1009540-H | 1000x950x400 | 1                | 2x5w       | - |
| EX-1209540-H | 1200x950x400 | 2                | 2x5w       | - |
| EX-1409540-H | 1400x950x400 | 2                | 2x5w       | - |
| EX-1509540-H | 1500x950x400 | 2                | 2x5w       | - |
| EX-1609540-H | 1600x950x400 | 2                | 2x5w       | - |
| EX-1809540-H | 1800x950x400 | 3                | 3x5w       | - |
| EX-2009540-H | 2000x950x400 | 3                | 3x5w       | - |
| EX-2209540-H | 2200x950x400 | 3                | 3x5w       | - |
| EX-2409540-H | 2400x950x400 | 4                | 3x5w       | - |
| EX-2509540-H | 2500x950x400 | 4                | 4x5w       | - |
| EX-2609540-H | 2600x950x400 | 4                | 4x5w       | - |
| EX-2809540-H | 2800x950x400 | 5                | 4x5w       | - |
| EX-3009540-H | 3000x950x400 | 5                | 4x5w       | - |
| EX-3209540-H | 3200x950x400 | 5                | 4x5w       | - |
| EX-3409540-H | 3400x950x400 | 6                | 5x5w       | - |
| EX-3509540-H | 3500x950x400 | 6                | 5x5w       | - |
| EX-3609540-H | 3600x950x400 | 6                | 5x5w       | - |
| EX-3809540-H | 3800x950x400 | 6                | 5x5w       | - |
| EX-4009540-H | 4000x950x400 | 7                | 5x5w       | - |

AYIRICI KUTU MODELİ  
EXTRACTOR BOX MODEL

EX 950-B

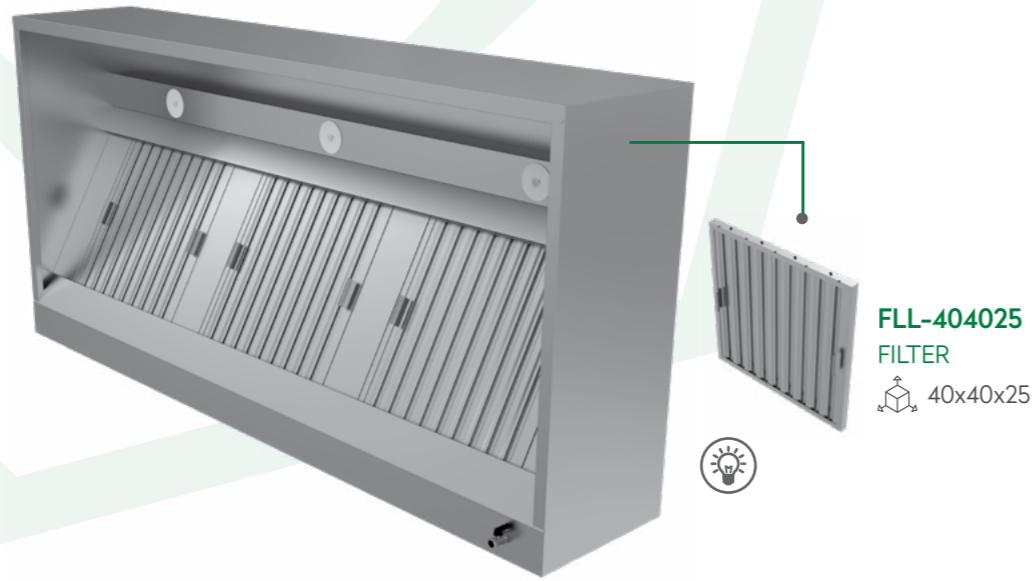
FLL-404025  
FILTER  
40x40x25AYIRICI KUTU MODELİ  
EXTRACTOR BOX MODEL

EX 1100-B

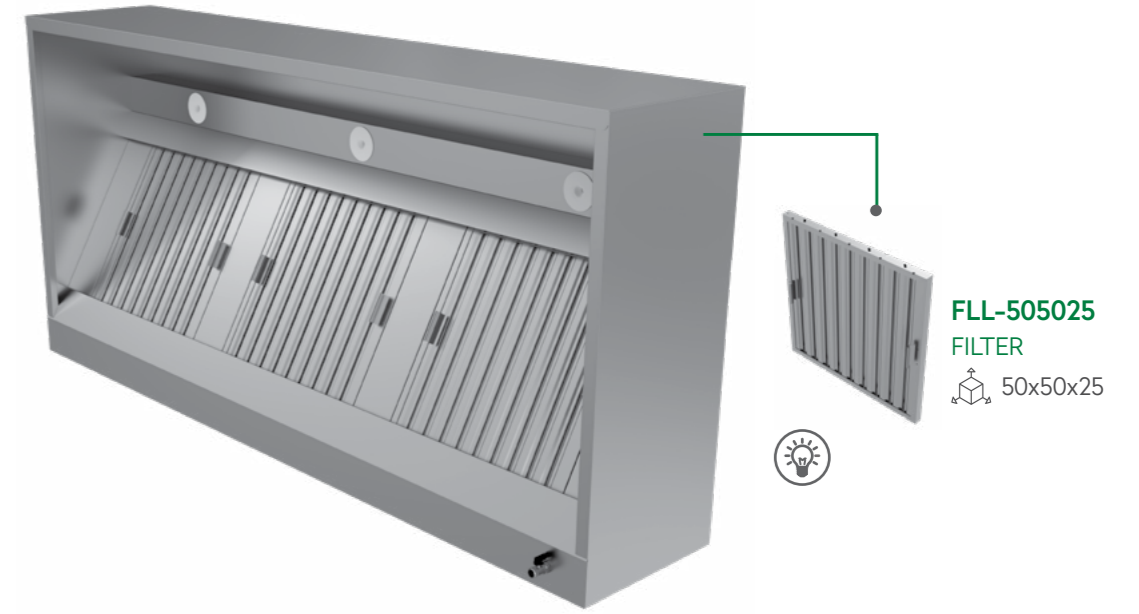
FLL-505025  
FILTER  
50x50x25

## TEKNİK DETAYLAR / TECHNICAL DETAILS

TR

- Paslanmaz Çelik AISI 430'dan üretilmiştir
- Davlumbaz dikdörtgen şeklindedir ve filtreler 45 derece açıyla monte edilmiştir.
- Dahili standart 5W'lı LED Işık
- Yağ tahliye valfli standart olarak üretilir.
- 495 x 495 mm labirent filtreler dahil

EN

- Brushed structure stainless steel AISI 430
- The hood is rectangular and the filters are installed with an angle of 45°
- Standard with Led Lightning 5W built-in
- Standard produced with fat drain valve
- Included Labyrinth filters 495 x 495 mm

| KOD CODE     | (MM)         | LA BYRINT FILTER | LED LIGHTS | € |
|--------------|--------------|------------------|------------|---|
| EX-1009540-B | 1000x950x400 | 1                | 2x5w       | - |
| EX-1209540-B | 1200x950x400 | 2                | 2x5w       | - |
| EX-1409540-B | 1400x950x400 | 2                | 2x5w       | - |
| EX-1509540-B | 1500x950x400 | 2                | 2x5w       | - |
| EX-1609540-B | 1600x950x400 | 2                | 2x5w       | - |
| EX-1809540-B | 1800x950x400 | 3                | 3x5w       | - |
| EX-2009540-B | 2000x950x400 | 3                | 3x5w       | - |
| EX-2209540-B | 2200x950x400 | 3                | 3x5w       | - |
| EX-2409540-B | 2400x950x400 | 4                | 3x5w       | - |
| EX-2509540-B | 2500x950x400 | 4                | 4x5w       | - |
| EX-2609540-B | 2600x950x400 | 4                | 4x5w       | - |
| EX-2809540-B | 2800x950x400 | 5                | 4x5w       | - |
| EX-3009540-B | 3000x950x400 | 5                | 4x5w       | - |
| EX-3209540-B | 3200x950x400 | 5                | 4x5w       | - |
| EX-3409540-B | 3400x950x400 | 6                | 5x5w       | - |
| EX-3509540-B | 3500x950x400 | 6                | 5x5w       | - |
| EX-3609540-B | 3600x950x400 | 6                | 5x5w       | - |
| EX-3809540-B | 3800x950x400 | 6                | 5x5w       | - |
| EX-4009540-B | 4000x950x400 | 7                | 5x5w       | - |

## TEKNİK DETAYLAR / TECHNICAL DETAILS

TR

- Paslanmaz Çelik AISI 430'dan üretilmiştir
- Davlumbaz dikdörtgen şeklindedir ve filtreler 45 derece açıyla monte edilmiştir.
- Dahili standart 5W'lı LED Işık
- Yağ tahliye valfli standart olarak üretilir.
- 495x495 mm labirent filtreler dahil

EN

- Brushed structure stainless steel AISI 430
- The hood is rectangular and the filters are installed with an angle of 45°
- Standard with Led Lightning 5W built-in
- Standard produced with fat drain valve
- Included Labyrinth filters 495x495 mm

| KOD CODE      | (MM)          | LA BYRINT FILTER | LED LIGHTS | € |
|---------------|---------------|------------------|------------|---|
| EX-10011040-B | 1000x1100x400 | 1                | 2x5w       | - |
| EX-12011040-B | 1200x1100x400 | 2                | 2x5w       | - |
| EX-14011040-B | 1400x1100x400 | 2                | 2x5w       | - |
| EX-15011040-B | 1500x1100x400 | 2                | 2x5w       | - |
| EX-16011040-B | 1600x1100x400 | 2                | 2x5w       | - |
| EX-18011040-B | 1800x1100x400 | 3                | 3x5w       | - |
| EX-20011040-B | 2000x1100x400 | 3                | 3x5w       | - |
| EX-22011040-B | 2200x1100x400 | 3                | 3x5w       | - |
| EX-24011040-B | 2400x1100x400 | 4                | 3x5w       | - |
| EX-25011040-B | 2500x1100x400 | 4                | 4x5w       | - |
| EX-26011040-B | 2600x1100x400 | 4                | 4x5w       | - |
| EX-28011040-B | 2800x1100x400 | 5                | 4x5w       | - |
| EX-30011040-B | 3000x1100x400 | 5                | 4x5w       | - |
| EX-32011040-B | 3200x1100x400 | 6                | 4x5w       | - |
| EX-34011040-B | 3400x1100x400 | 6                | 5x5w       | - |
| EX-35011040-B | 3500x1100x400 | 6                | 5x5w       | - |
| EX-36011040-B | 3600x1100x400 | 7                | 5x5w       | - |
| EX-38011040-B | 3800x1100x400 | 7                | 5x5w       | - |
| EX-40011040-B | 4000x1100x400 | 7                | 5x5w       | - |

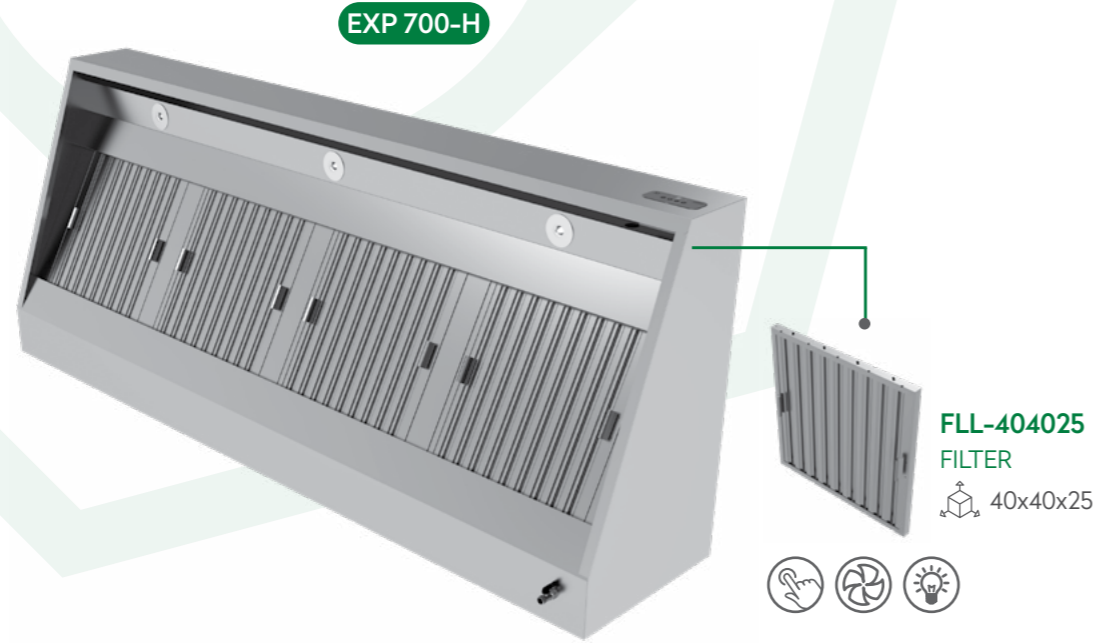
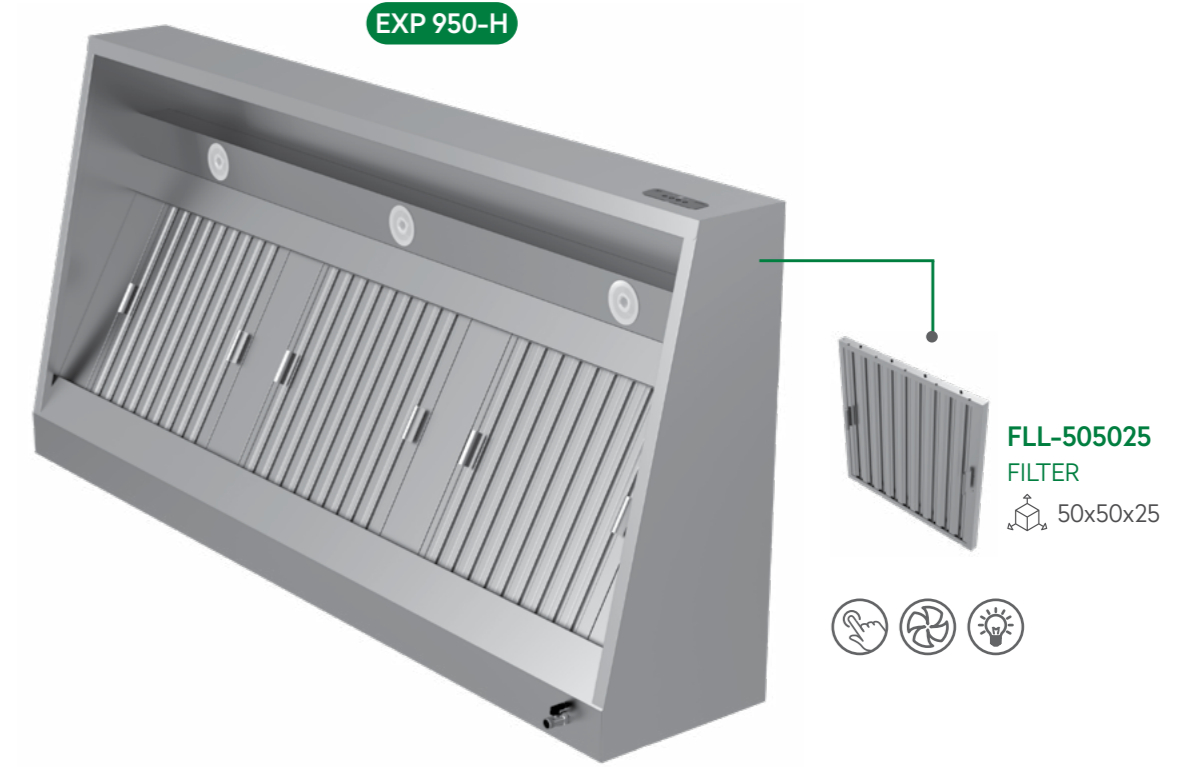
HAVALANDIRMALI DAVLUMBAZ - MOTORLU  
EXTRACTOR HOOD WITH VENTILATOR - PLUG & PLAYHAVALANDIRMALI DAVLUMBAZ - MOTORLU  
EXTRACTOR HOOD WITH VENTILATOR - PLUG & PLAY

## TEKNİK DETAYLAR / TECHNICAL DETAILS

TR

- Paslanmaz Çelik AISI 430'dan üretilmiştir
- Davlumbaz dikdörtgen şeklindedir ve filtreler 45 derece açıyla monte edilmiştir.
- Dahili standart 5W'lı LED ışık
- Yağ tahliye valfli standart olarak üretilir.
- 400x400mm labirent filtreler dahil
- Açma/Kapama ışığı ve düğmeli Açma/Kapama gaz vanası dahildir.

EN

- Brushed structure stainless steel AISI 430
- The hood is slant and the filters are installed with an angle of 45°
- Standard with Led Lightning 5W built-in
- Standard produced with fat drain valve
- Included Labyrinth filters 400x400 mm
- Included On/Off controller with lightning & gasvalve on/off switch buttons

| KOD CODE      | [MM]         | LA BYRINT FILTER | LED LIGHTS | CAPACITY              | € |
|---------------|--------------|------------------|------------|-----------------------|---|
| EXP-1007054-H | 1000x700x540 | 2                | 2x5w       | 1500m <sup>3</sup> /h | - |
| EXP-1207054-H | 1200x700x540 | 2                | 2x5w       | 1500m <sup>3</sup> /h | - |
| EXP-1507054-H | 1500x700x540 | 3                | 2x5w       | 1500m <sup>3</sup> /h | - |
| EXP-1607054-H | 1600x700x540 | 3                | 2x5w       | 1500m <sup>3</sup> /h | - |
| EXP-2007054-H | 2000x700x540 | 4                | 3x5w       | 1500m <sup>3</sup> /h | - |
| EXP-2407054-H | 2400x700x540 | 4                | 3x5w       | 2500m <sup>3</sup> /h | - |
| EXP-2507054-H | 2500x700x540 | 4                | 4x5w       | 2500m <sup>3</sup> /h | - |
| EXP-3007054-H | 3000x700x540 | 5                | 5x5w       | 2500m <sup>3</sup> /h | - |

## TEKNİK DETAYLAR / TECHNICAL DETAILS

TR

- Paslanmaz Çelik AISI 430'dan üretilmiştir
- Davlumbaz dikdörtgen şeklindedir ve filtreler 45 derece açıyla monte edilmiştir.
- Dahili standart 5W'lı LED ışık
- Yağ tahliye valfli standart olarak üretilir.
- 495 x 495 mm labirent filtreler dahil
- Açma/Kapama ışığı ve düğmeli Açma/Kapama gaz vanası dahildir.

EN

- Brushed structure stainless steel AISI 430
- The hood is slant and the filters are installed with an angle of 45°
- Standard with Led Lightning 5W built-in
- Standard produced with fat drain valve
- Included Labyrinth filters 495 x 495 mm
- Included On/Off controller with lightning & gasvalve on/off switch buttons

| KOD CODE      | [MM]         | LA BYRINT FILTER | LED LIGHTS | CAPACITY              | € |
|---------------|--------------|------------------|------------|-----------------------|---|
| EXP-1009552-H | 1000x950x520 | 1                | 2x5w       | 1500m <sup>3</sup> /h | - |
| EXP-1209552-H | 1200x950x520 | 2                | 2x5w       | 1500m <sup>3</sup> /h | - |
| EXP-1509552-H | 1500x950x520 | 2                | 2x5w       | 1500m <sup>3</sup> /h | - |
| EXP-1609552-H | 1600x950x520 | 2                | 2x5w       | 1500m <sup>3</sup> /h | - |
| EXP-2009552-H | 2000x950x520 | 3                | 3x5w       | 1500m <sup>3</sup> /h | - |
| EXP-2409552-H | 2400x950x520 | 4                | 3x5w       | 2500m <sup>3</sup> /h | - |
| EXP-2509552-H | 2500x950x520 | 4                | 4x5w       | 2500m <sup>3</sup> /h | - |
| EXP-3009552-H | 3000x950x520 | 5                | 5x5w       | 2500m <sup>3</sup> /h | - |

AYIRICI KUTU MODELİ - MOTORLU  
EXTRACTOR BOX MODEL - PLUG & PLAY

EXP 950-B

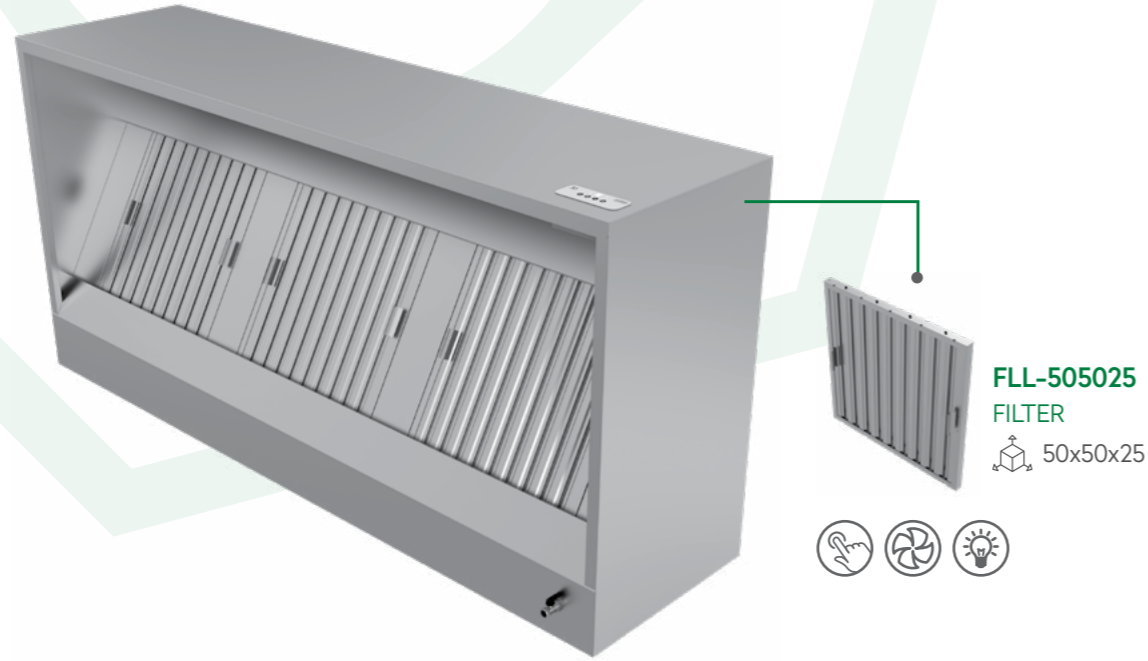
MERKEZİ DAVLUMBAZ MODELİ  
EXTRACTOR CENTRAL HOOD MODEL

EX 1500-C

EX 2000-C



## TEKNİK DETAYLAR / TECHNICAL DETAILS

TR

- Paslanmaz Çelik AISI 430'dan üretilmiştir
- Davlumbaz dikdörtgen şeklindedir ve filtreler 45 derece açıyla monte edilmiştir.
- Dahili standart 5W'lı LED Işık
- Yağ tahliye valfli standart olarak üretilir.
- 495 x 495 mm labirent filtreler dahil
- Açma/Kapama ışığı ve düğmeli Açma/Kapama gaz vanası dahildir.

EN

- Brushed structure stainless steel AISI 430
- The hood is rectangular and the filters are installed with an angle of 45°
- Standard with Led Lightning 5W built-in
- Standard produced with fat drain valve
- Included Labyrinth filters 495 x 495 mm
- Included On/Off controller with lightning & gasvalve on/off switch buttons

| KOD CODE      | (MM)         | LA BYRINT FILTER | LED LIGHTS | CAPACITY              | € |
|---------------|--------------|------------------|------------|-----------------------|---|
| EXP-1009552-B | 1000x950x520 | 1                | 2x5w       | 1500m <sup>3</sup> /h | - |
| EXP-1209552-B | 1200x950x520 | 2                | 2x5w       | 1500m <sup>3</sup> /h | - |
| EXP-1509552-B | 1500x950x520 | 2                | 2x5w       | 1500m <sup>3</sup> /h | - |
| EXP-1609552-B | 1600x950x520 | 2                | 2x5w       | 1500m <sup>3</sup> /h | - |
| EXP-2009552-B | 2000x950x520 | 3                | 3x5w       | 1500m <sup>3</sup> /h | - |
| EXP-2409552-B | 2400x950x520 | 4                | 3x5w       | 2500m <sup>3</sup> /h | - |
| EXP-2509552-B | 2500x950x520 | 4                | 4x5w       | 2500m <sup>3</sup> /h | - |
| EXP-3009552-B | 3000x950x520 | 5                | 5x5w       | 2500m <sup>3</sup> /h | - |

## TEKNİK DETAYLAR / TECHNICAL DETAILS

TR

- Paslanmaz Çelik AISI 430'dan üretilmiştir
- Davlumbaz dikdörtgen şeklindedir ve filtreler 45 derece açıyla monte edilmiştir.
- Dahili standart 5W'lı LED Işık
- Damlatmayan, hermetik olarak kapatılmış gres toplama kanalı
- 495 x 495 mm labirent filtreler dahil

EN

- Brushed structure stainless steel AISI 430
- The hood is rectangular and the filters are installed with an angle of 45°
- Standard with Led Lightning 5W built-in
- Drip-free, hermetically sealed grease collection channel
- Included Labyrinth filters 495 x 495 mm

| KOD CODE      | (MM)          | LA BYRINT FILTER | LED LIGHTS | € |
|---------------|---------------|------------------|------------|---|
| EX-20015040-C | 2000x1500x400 | 2 x 3            | 6x5w       | - |
| EX-25015040-C | 2500x1500x400 | 2 x 4            | 8x5w       | - |
| EX-30015040-C | 3000x1500x400 | 2 x 5            | 8x5w       | - |
| EX-35015040-C | 3500x1500x400 | 2 x 6            | 10x5w      | - |
| EX-40015040-C | 4000x1500x400 | 2 x 7            | 10x5w      | - |
| EX-45015040-C | 4500x1500x400 | 2 x 7            | 12x5w      | - |
| EX-50015040-C | 5000x1500x400 | 2 x 8            | 12x5w      | - |

| KOD CODE      | (MM)          | LA BYRINT FILTER | LED LIGHTS | € |
|---------------|---------------|------------------|------------|---|
| EX-20020040-C | 2000x2000x400 | 2 x 3            | 6x5w       | - |
| EX-25020040-C | 2500x2000x400 | 2 x 4            | 8x5w       | - |
| EX-30020040-C | 3000x2000x400 | 2 x 5            | 8x5w       | - |
| EX-35020040-C | 3500x2000x400 | 2 x 6            | 10x5w      | - |
| EX-40020040-C | 4000x2000x400 | 2 x 7            | 10x5w      | - |
| EX-45020040-C | 4500x2000x400 | 2 x 7            | 12x5w      | - |
| EX-50020040-C | 5000x2000x400 | 2 x 8            | 12x5w      | - |

EXP 1300-IP

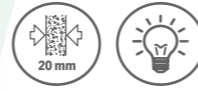
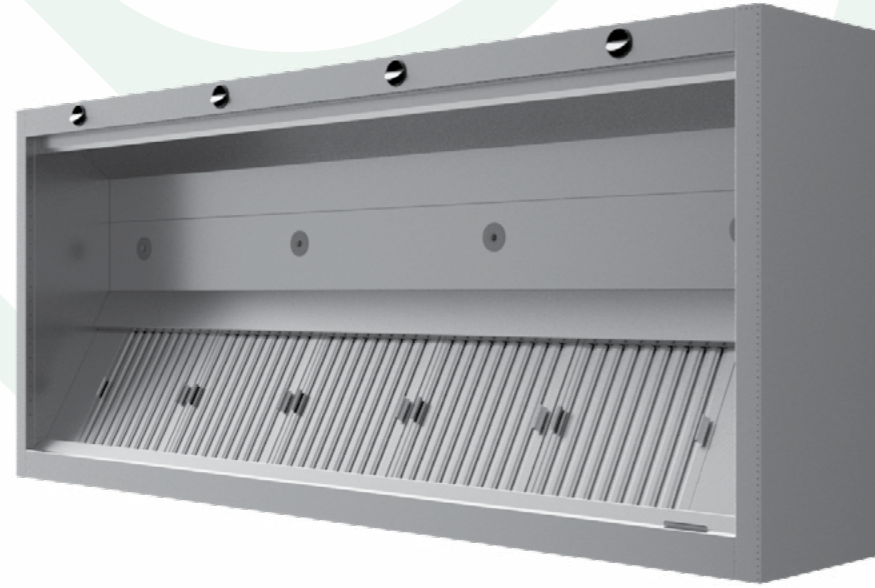

EXP 2200-C

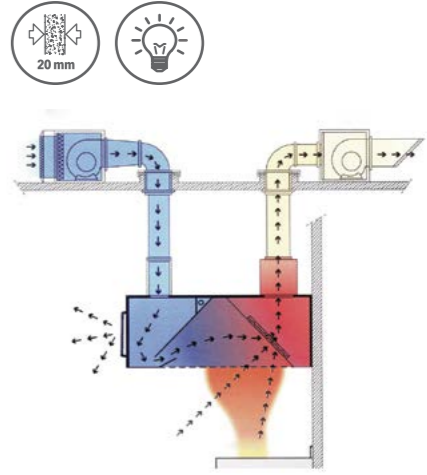
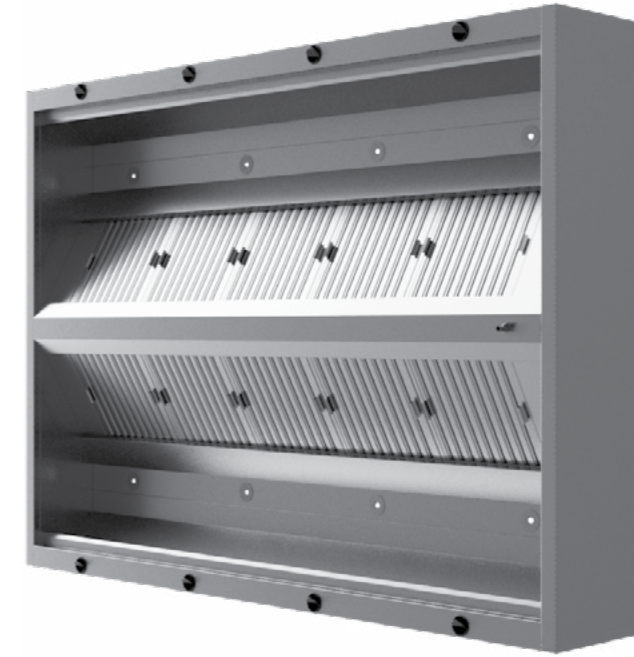

## TEKNİK DETAYLAR / TECHNICAL DETAILS

TR

- Paslanmaz Çelik AISI 430'dan üretilmiştir
- Davlumbaz dikdörtgen şeklindedir ve filtreler 45 derece açıyla monte edilmiştir.
- 20mm yalıtım kalınlığı ile izole edilmiş hava verme alanı.
- Dahili standart 5W'lı LED ışık
- Damlatmayan, hermetik olarak kapatılmış gres toplama kanalı
- 495 x 495 mm labirent filtreler dahil
- Önde hava giriş valfi dahil

EN

- Brushed structure stainless steel AISI 430
- The hood is rectangular and the filters are installed with an angle of 45°
- Air supply space isolated with 20mm insulation thickness.
- Standard with Led Lightning 5W built-in
- Drip-free, hermetically sealed grease collection channel
- Included Labyrinth filters 495 x 495 mm
- Including air inlet valve at the front

| KOD CODE       | (MM)          | LA BYRINT FILTER | LED LIGHTS | € |
|----------------|---------------|------------------|------------|---|
| EX-20013055-IP | 2000x1300x550 | 3                | 3x5w       | - |
| EX-25013055-IP | 2500x1300x550 | 4                | 4x5w       | - |
| EX-30013055-IP | 3000x1300x550 | 5                | 4x5w       | - |
| EX-35013055-IP | 3500x1300x550 | 6                | 5x5w       | - |
| EX-40013055-IP | 4000x1300x550 | 7                | 5x5w       | - |
| EX-45013055-IP | 4500x1300x550 | 7                | 6x5w       | - |
| EX-50013055-IP | 5000x1300x550 | 8                | 8x5w       | - |

## TEKNİK DETAYLAR / TECHNICAL DETAILS

TR

- Paslanmaz Çelik AISI 430'dan üretilmiştir
- Davlumbaz dikdörtgen şeklindedir ve filtreler 45 derece açıyla monte edilmiştir.
- 20mm yalıtım kalınlığı ile izole edilmiş hava verme alanı.
- Dahili standart 5W'lı LED ışık
- Damlatmayan, hermetik olarak kapatılmış gres toplama kanalı
- 495 x 495 mm labirent filtreler dahil
- Önde hava giriş valfi dahil

EN

- Brushed structure stainless steel AISI 430
- The hood is rectangular and the filters are installed with an angle of 45°
- Air supply space isolated with 20mm insulation thickness.
- Standard with Led Lightning 5W built-in
- Drip-free, hermetically sealed grease collection channel
- Included Labyrinth filters 495 x 495 mm
- Including air inlet valve at the front

| KOD CODE      | (MM)          | LA BYRINT FILTER | LED LIGHTS | € |
|---------------|---------------|------------------|------------|---|
| EX-20022050-C | 2000x2200x550 | 2 x 3            | 6x5w       | - |
| EX-25022050-C | 2500x2200x550 | 2 x 4            | 8x5w       | - |
| EX-30022050-C | 3000x2200x550 | 2 x 5            | 8x5w       | - |
| EX-35022050-C | 3500x2200x550 | 2 x 6            | 10x5w      | - |
| EX-40022050-C | 4000x2200x550 | 2 x 7            | 10x5w      | - |
| EX-45022050-C | 4500x2200x550 | 2 x 7            | 12x5w      | - |
| EX-50022050-C | 5000x2200x550 | 2 x 8            | 16x5w      | - |

YARDIMCI  
PASLANMAZ  
ÜRÜNLER



AUXILIARY  
INOX  
PRODUCTS



## YARDIMCI NOX ÜRÜNLER AUXILIARY INOX PRODUCTS

DİZDEN KUMANDALI EVYE VE PASPAS YIKAMA EVYESİ  
KNEE OPERATED HANDWASH SINK AND JANITORIAL SINK



### TEKNİK DETAYLAR / TECHNICAL DETAILS

TR

- AISI-304 Paslanmaz Çelik
- Polisajlanmış yüzey
- 1" 1/2 Sifon ölçüsü
- Köşeli kenar

EN

- AISI-304 Stainless steel
- Electropolished material
- 1" 1/2 Siphon diameter
- Cornered edge

| KOD CODE | (MM)        | € |
|----------|-------------|---|
| AIM KO1  | 390x360x210 | - |
| AIM JS1  | 500x600x900 | - |
| AIM JS2  | 500x700x900 | - |

YER GİDERLERİ  
CENTER DRAIN



NEW  
PRODUCT

ALTTAN ÇIKIŞLI ORTADAN SİFONLU YER GİDERİ  
BOTTOM OUTLET CENTER DRAIN

| KOD CODE       | (MM)     | ÇIKIŞ<br>EXIT | € |
|----------------|----------|---------------|---|
| AIM FDCOB3030  | 300x300  | ø 70 - ø100   | - |
| AIM FDCOB3050  | 300x500  | ø 70 - ø100   | - |
| AIM FDCOB3075  | 300x750  | ø 70 - ø100   | - |
| AIM FDCOB3095  | 300x950  | ø 70 - ø100   | - |
| AIM FDCOB30120 | 300x1200 | ø 70 - ø100   | - |
| AIM FDCOB30140 | 300x1400 | ø 70 - ø100   | - |
| AIM FDCOB30165 | 300x1650 | ø 70 - ø100   | - |
| AIM FDCOB30185 | 300x1850 | ø 70 - ø100   | - |
| AIM FDCOB30210 | 300x2100 | ø 70 - ø100   | - |
| AIM FDCOB30230 | 300x2300 | ø 70 - ø100   | - |



YANDAN ÇIKIŞLI ORTADAN SİFONLU YER GİDERİ  
SIDE OUTLET CENTER DRAIN

| KOD CODE         | (MM)     | ÇIKIŞ<br>EXIT | € |
|------------------|----------|---------------|---|
| AIM FDCOB3030-Y  | 300x300  | ø 50 - ø 70   | - |
| AIM FDCOB3050-Y  | 300x500  | ø 50 - ø 70   | - |
| AIM FDCOB3075-Y  | 300x750  | ø 50 - ø 70   | - |
| AIM FDCOB3095-Y  | 300x950  | ø 50 - ø 70   | - |
| AIM FDCOB30120-Y | 300x1200 | ø 50 - ø 70   | - |
| AIM FDCOB30140-Y | 300x1400 | ø 50 - ø 70   | - |
| AIM FDCOB30165-Y | 300x1650 | ø 50 - ø 70   | - |
| AIM FDCOB30185-Y | 300x1850 | ø 50 - ø 70   | - |
| AIM FDCOB30210-Y | 300x2100 | ø 50 - ø 70   | - |
| AIM FDCOB30230-Y | 300x2300 | ø 50 - ø 70   | - |

PASLANMAZ ÇELİK TEL RAFLAR  
STAINLESS STEEL WIRE SHELVING

AISI 304

| KOD CODE       | [MM]          | € |
|----------------|---------------|---|
| AIM184691-3WLS | 460x910x1830  | - |
| AIM184610-3WLS | 460x1070x1830 | - |
| AIM184612-3WLS | 460x1220x1830 | - |
| AIM184613-3WLS | 460x1370x1830 | - |
| AIM184615-3WLS | 460x1520x1830 | - |
| AIM184618-3WLS | 460x1830x1830 | - |
| AIM185391-3WLS | 530x910x1830  | - |
| AIM185310-3WLS | 530x1070x1830 | - |
| AIM185312-3WLS | 530x1220x1830 | - |
| AIM185313-3WLS | 530x1370x1830 | - |
| AIM185315-3WLS | 530x1520x1830 | - |
| AIM185318-3WLS | 530x1830x1830 | - |
| AIM186191-3WLS | 610x910x1830  | - |
| AIM186110-3WLS | 610x1070x1830 | - |
| AIM186112-3WLS | 610x1220x1830 | - |
| AIM186113-3WLS | 610x1370x1830 | - |
| AIM186115-3WLS | 610x1520x1830 | - |
| AIM186118-3WLS | 610x1830x1830 | - |

AISI 201

| KOD CODE       | [MM]          | € |
|----------------|---------------|---|
| AIM184691-2WLS | 460x910x1830  | - |
| AIM184610-2WLS | 460x1070x1830 | - |
| AIM184612-2WLS | 460x1220x1830 | - |
| AIM184613-2WLS | 460x1370x1830 | - |
| AIM184615-2WLS | 460x1520x1830 | - |
| AIM184618-2WLS | 460x1830x1830 | - |
| AIM185391-2WLS | 530x910x1830  | - |
| AIM185310-2WLS | 530x1070x1830 | - |
| AIM185312-2WLS | 530x1220x1830 | - |
| AIM185313-2WLS | 530x1370x1830 | - |
| AIM185315-2WLS | 530x1520x1830 | - |
| AIM185318-2WLS | 530x1830x1830 | - |
| AIM186191-2WLS | 610x910x1830  | - |
| AIM186110-2WLS | 610x1070x1830 | - |
| AIM186112-2WLS | 610x1220x1830 | - |
| AIM186113-2WLS | 610x1370x1830 | - |
| AIM186115-2WLS | 610x1520x1830 | - |
| AIM186118-2WLS | 610x1830x1830 | - |

PASLANMAZ ÇELİK DÜZ RAFLAR  
STAINLESS STEEL SOLID SHELVES

AISI 304

| KOD CODE      | [MM]          | € |
|---------------|---------------|---|
| AIM184691-3DS | 460x910x1830  | - |
| AIM184610-3DS | 460x1070x1830 | - |
| AIM184612-3DS | 460x1220x1830 | - |
| AIM184613-3DS | 460x1370x1830 | - |
| AIM184615-3DS | 460x1520x1830 | - |
| AIM184618-3DS | 460x1830x1830 | - |
| AIM185391-3DS | 530x910x1830  | - |
| AIM185310-3DS | 530x1070x1830 | - |
| AIM185312-3DS | 530x1220x1830 | - |
| AIM185313-3DS | 530x1370x1830 | - |
| AIM185315-3DS | 530x1520x1830 | - |
| AIM185318-3DS | 530x1830x1830 | - |
| AIM186191-3DS | 610x910x1830  | - |
| AIM186110-3DS | 610x1070x1830 | - |
| AIM186112-3DS | 610x1220x1830 | - |
| AIM186113-3DS | 610x1370x1830 | - |
| AIM186115-3DS | 610x1520x1830 | - |
| AIM186118-3DS | 610x1830x1830 | - |

AISI 201

| KOD CODE      | [MM]          | € |
|---------------|---------------|---|
| AIM184691-2DS | 460x910x1830  | - |
| AIM184610-2DS | 460x1070x1830 | - |
| AIM184612-2DS | 460x1220x1830 | - |
| AIM184613-2DS | 460x1370x1830 | - |
| AIM184615-2DS | 460x1520x1830 | - |
| AIM184618-2DS | 460x1830x1830 | - |
| AIM185391-2DS | 530x910x1830  | - |
| AIM185310-2DS | 530x1070x1830 | - |
| AIM185312-2DS | 530x1220x1830 | - |
| AIM185313-2DS | 530x1370x1830 | - |
| AIM185315-2DS | 530x1520x1830 | - |
| AIM185318-2DS | 530x1830x1830 | - |
| AIM186191-2DS | 610x910x1830  | - |
| AIM186110-2DS | 610x1070x1830 | - |
| AIM186112-2DS | 610x1220x1830 | - |
| AIM186113-2DS | 610x1370x1830 | - |
| AIM186115-2DS | 610x1520x1830 | - |
| AIM186118-2DS | 610x1830x1830 | - |

# YARDIMCI NOX ÜRÜNLER

## AUXILIARY INOX PRODUCTS

PASLANMAZ ÇELİK DELİKLİ RAFLAR  
STAINLESS STEEL PERFORATED SHELVES

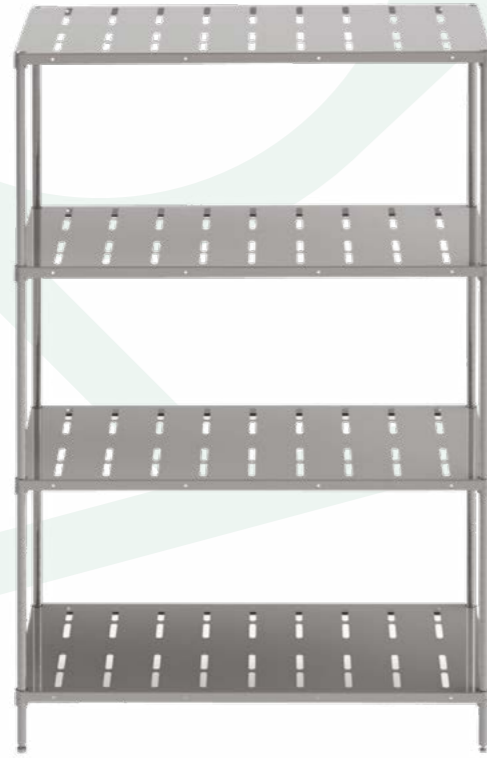

AISI 304

| KOD CODE      | (MM)          | € |
|---------------|---------------|---|
| AIM184691-3DD | 460x910x1830  | - |
| AIM184610-3DD | 460x1070x1830 | - |
| AIM184612-3DD | 460x1220x1830 | - |
| AIM184613-3DD | 460x1370x1830 | - |
| AIM184615-3DD | 460x1520x1830 | - |
| AIM184618-3DD | 460x1830x1830 | - |
| AIM185391-3DD | 530x910x1830  | - |
| AIM185310-3DD | 530x1070x1830 | - |
| AIM185312-3DD | 530x1220x1830 | - |
| AIM185313-3DD | 530x1370x1830 | - |
| AIM185315-3DD | 530x1520x1830 | - |
| AIM185318-3DD | 530x1830x1830 | - |
| AIM186191-3DD | 610x910x1830  | - |
| AIM186110-3DD | 610x1070x1830 | - |
| AIM186112-3DD | 610x1220x1830 | - |
| AIM186113-3DD | 610x1370x1830 | - |
| AIM186115-3DD | 610x1520x1830 | - |
| AIM186118-3DD | 610x1830x1830 | - |

AISI 201

| KOD CODE      | (MM)          | € |
|---------------|---------------|---|
| AIM184691-2DD | 460x910x1830  | - |
| AIM184610-2DD | 460x1070x1830 | - |
| AIM184612-2DD | 460x1220x1830 | - |
| AIM184613-2DD | 460x1370x1830 | - |
| AIM184615-2DD | 460x1520x1830 | - |
| AIM184618-2DD | 460x1830x1830 | - |
| AIM185391-2DD | 530x910x1830  | - |
| AIM185310-2DD | 530x1070x1830 | - |
| AIM185312-2DD | 530x1220x1830 | - |
| AIM185313-2DD | 530x1370x1830 | - |
| AIM185315-2DD | 530x1520x1830 | - |
| AIM185318-2DD | 530x1830x1830 | - |
| AIM186191-2DD | 610x910x1830  | - |
| AIM186110-2DD | 610x1070x1830 | - |
| AIM186112-2DD | 610x1220x1830 | - |
| AIM186113-2DD | 610x1370x1830 | - |
| AIM186115-2DD | 610x1520x1830 | - |
| AIM186118-2DD | 610x1830x1830 | - |

ALÜMİNYUM AYAKLI POLİPROPİLEN RAFLAR  
ALUMINIUM LEGS POLYPROPYLENE SHELVING



| KOD CODE      | (MM)          | € |
|---------------|---------------|---|
| AIM-7036-HPP  | 700x360x1830  | - |
| AIM-8036-HPP  | 800x360x1830  | - |
| AIM-9036-HPP  | 900x360x1830  | - |
| AIM-10536-HPP | 1005x360x1830 | - |
| AIM-11536-HPP | 1105x360x1830 | - |
| AIM-12536-HPP | 1205x360x1830 | - |
| AIM-13536-HPP | 1305x360x1830 | - |
| AIM-14136-HPP | 1410x360x1830 | - |
| AIM-15136-HPP | 1-x360x1830   | - |
| AIM-16136-HPP | 1610x360x1830 | - |
| AIM-17136-HPP | 1710x360x1830 | - |
| AIM-18136-HPP | 1810x360x1830 | - |

| KOD CODE      | (MM)          | € |
|---------------|---------------|---|
| AIM-7046-HPP  | 700x460x1830  | - |
| AIM-8046-HPP  | 800x460x1830  | - |
| AIM-9046-HPP  | 900x460x1830  | - |
| AIM-10546-HPP | 1005x460x1830 | - |
| AIM-11546-HPP | 1105x460x1830 | - |
| AIM-12546-HPP | 1205x460x1830 | - |
| AIM-13546-HPP | 1305x460x1830 | - |
| AIM-14146-HPP | 1410x460x1830 | - |
| AIM-15146-HPP | 1-x460x1830   | - |
| AIM-16146-HPP | 1610x460x1830 | - |
| AIM-17146-HPP | 1710x460x1830 | - |
| AIM-18146-HPP | 1810x460x1830 | - |

| KOD CODE      | (MM)          | € |
|---------------|---------------|---|
| AIM-7056-HPP  | 700x560x1830  | - |
| AIM-8056-HPP  | 800x560x1830  | - |
| AIM-9056-HPP  | 900x560x1830  | - |
| AIM-10556-HPP | 1005x560x1830 | - |
| AIM-11556-HPP | 1105x560x1830 | - |
| AIM-12556-HPP | 1205x560x1830 | - |
| AIM-13556-HPP | 1305x560x1830 | - |
| AIM-14156-HPP | 1410x560x1830 | - |
| AIM-15156-HPP | 1-x560x1830   | - |
| AIM-16156-HPP | 1610x560x1830 | - |
| AIM-17156-HPP | 1710x560x1830 | - |
| AIM-18156-HPP | 1810x560x1830 | - |



# YARDIMCI NOX ÜRÜNLER AUXILIARY INOX PRODUCTS

## GN KÜVETLER GN CONTAINERS

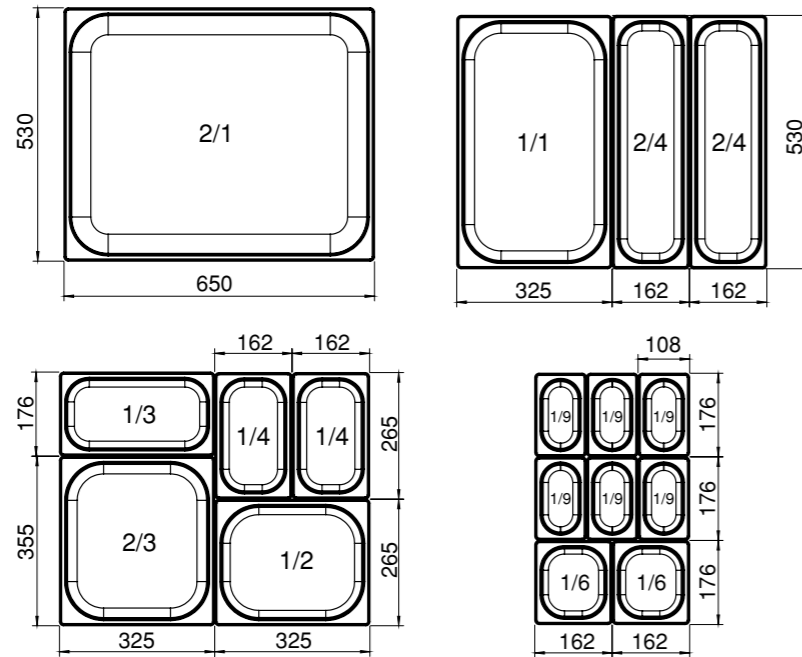

| KOD CODE | AÇIKLAMA DESCRIPTION | DIŞ ÖLÇÜ (MM)<br>EXT. DIM. (MM) | KOLİ ÖLÇÜ (MM)<br>BOX DIM. (MM) | KUTU ADEDİ<br>BOX UNIT | € |
|----------|----------------------|---------------------------------|---------------------------------|------------------------|---|
| 6005642  | 2/1-20               | 650x530x20                      | 660x550x120                     | 10                     | - |
| 6005660  | 2/1-40               | 650x530x40                      | 660x550x160                     | 10                     | - |
| 6005537  | 2/1-65               | 650x530x65                      | 660x550x160                     | 10                     | - |
| 6005538  | 2/1-100              | 650x530x100                     | 660x550x290                     | 10                     | - |
| 6005539  | 2/1-150              | 650x530x150                     | 660x550x360                     | 10                     | - |
| 6005643  | 2/1-200              | 650x530x200                     | 660x550x360                     | 5                      | - |
| 6005656  | 1/1-20               | 530x325x20                      | 540x360x120                     | 20                     | - |
| 6005510  | 1/1-40               | 530x325x40                      | 540x360x240                     | 20                     | - |
| 6005637  | 1/1-65               | 530x325x65                      | 540x360x240                     | 20                     | - |
| 6005657  | 1/1-100              | 530x325x100                     | 540x360x355                     | 15                     | - |
| 6005638  | 1/1-150              | 530x325x150                     | 540x360x420                     | 15                     | - |
| 6005512  | 1/1-200              | 530x325x200                     | 540x360x420                     | 10                     | - |
| 6005662  | 2/4-20               | 162x530x20                      | 540x360x120                     | 20                     | - |
| 6005547  | 2/4-40               | 162x530x40                      | 540x360x120                     | 20                     | - |
| 6005663  | 2/4-65               | 162x530x65                      | 540x360x290                     | 20                     | - |
| 6005548  | 2/4-100              | 162x530x100                     | 540x360x320                     | 20                     | - |
| 6005549  | 2/4-150              | 162x530x150                     | 540x360x420                     | 20                     | - |
| 6005541  | 2/3-20               | 354x325x20                      | 540x360x240                     | 20                     | - |
| 6005542  | 2/3-40               | 354x325x40                      | 540x360x240                     | 20                     | - |
| 6005545  | 2/3-65               | 354x325x65                      | 540x360x355                     | 20                     | - |
| 6005661  | 2/3-100              | 354x325x100                     | 540x360x420                     | 20                     | - |
| 6005644  | 2/3-150              | 354x325x150                     | 540x360x420                     | 15                     | - |
| 6005645  | 2/3-200              | 354x325x200                     | 540x360x420                     | 12                     | - |
| 6005514  | 1/2-20               | 325x265x20                      | 540x360x120                     | 20                     | - |
| 6005515  | 1/2-40               | 325x265x40                      | 540x360x120                     | 20                     | - |
| 6005517  | 1/2-60               | 325x265x65                      | 540x360x180                     | 20                     | - |
| 6005518  | 1/2-100              | 325x265x100                     | 540x360x240                     | 15                     | - |
| 6005519  | 1/2-150              | 325x265x150                     | 540x360x420                     | 20                     | - |
| 6005520  | 1/2-200              | 650x530x200                     | 540x360x420                     | 10                     | - |
| 6005639  | 1/3-20               | 325x176x20                      | 540x360x120                     | 25                     | - |
| 6005521  | 1/3-40               | 325x176x40                      | 540x360x120                     | 25                     | - |
| 6005523  | 1/3-65               | 325x176x65                      | 540x360x180                     | 20                     | - |
| 6005524  | 1/3-100              | 325x176x100                     | 540x360x290                     | 25                     | - |
| 6005525  | 1/3-150              | 325x176x150                     | 540x360x420                     | 20                     | - |
| 6005526  | 1/3-200              | 325x176x200                     | 540x360x420                     | 20                     | - |
| 6005527  | 1/4-20               | 265x162x20                      | 540x360x120                     | 25                     | - |
| 6005640  | 1/4-40               | 265x162x40                      | 540x360x120                     | 25                     | - |
| 6005528  | 1/4-65               | 265x162x65                      | 540x360x180                     | 25                     | - |
| 6005529  | 1/4-100              | 265x162x100                     | 540x360x240                     | 25                     | - |
| 6005530  | 1/4-150              | 265x162x150                     | 540x360x320                     | 20                     | - |
| 6005531  | 1/4-200              | 265x162x200                     | 540x360x180                     | 10                     | - |
| 6005658  | 1/6-65               | 176x162x65                      | 540x360x120                     | 25                     | - |
| 6005532  | 1/6-100              | 176x162x100                     | 540x360x180                     | 25                     | - |
| 6005533  | 1/6-150              | 176x162x150                     | 540x360x180                     | 25                     | - |
| 6005659  | 1/6-200              | 176x162x200                     | 540x360x180                     | 25                     | - |
| 6005534  | 1/9-65               | 176x108x65                      | 540x360x120                     | 25                     | - |
| 6005641  | 1/9-100              | 176x108x100                     | 540x360x120                     | 25                     | - |

# 600 SERİ PIŞİRME EKİPMANLARI



## 600 SERIES HOT LINE



AGO106







## TEKNİK DETAYLAR / TECHNICAL DETAILS

## TR

- Paslanmaz çelikten imal edilmiştir
- Paslanmaz sac konstrüksiyonu ile uzun ömürlü kolay temizlenebilir ve hijyeniktir
- Cihaz pilotlu ve termokupullu kontrol sistemi bulunmaktadır.
- LPG ve NG seçenekleri mevcuttur
- Pişirici hızı yüksek alev veya düşük alev olarak ayarlanabilir

## EN

- Made of stainless steel
- Stainless steel sheet construction provides hygiene, long service life and easy of cleaning
- Piloted and thermocouple control system
- LPG and NG options available
- The device speed set up to high or low flame

|   | KOD / CODE | (MM)         | kg | (KW) | € |
|---|------------|--------------|----|------|---|
|  | AIM AGO46  | 400x600x300  | 30 | 11,5 | - |
|  | AIM AGO66  | 600x600x300  | 34 | 23   | - |
|  | AIM AGO86  | 800x600x300  | 42 | 23   | - |
|  | AIM AGO106 | 1000x600x300 | 65 | 34,5 | - |

AEO106







## TEKNİK DETAYLAR / TECHNICAL DETAILS

## TR

- Paslanmaz çelikten imal edilmiştir
- Paslanmaz sac konstrüksiyonu ile uzun ömürlü kolay temizlenebilir ve hijyeniktir
- Cihaz üzerinde bulunan 6 kademeli termostat ile ısıyı istenilen şekilde ayarlayabilme imkanı sağlar

## EN

- Made of stainless steel
- Stainless steel sheet construction provides hygiene, long service life and easy of cleaning
- With the 6 steps thermostat on the device, it provides the opportunity to adjust the temperature as requested

|   | KOD / CODE | (MM)         | kg | (KW)      | €  |   |
|---|------------|--------------|----|-----------|----|---|
|  | AIM AEO46  | 400x600x300  | 20 | 380-410 V | 4  | - |
|  | AIM AEO66  | 600x600x300  | 28 | 380-410 V | 8  | - |
|  | AIM AEO86  | 800x600x300  | 32 | 380-410 V | 8  | - |
|  | AIM AEO106 | 1000x600x300 | 54 | 380-410 V | 12 | - |

AGW86





## TEKNİK DETAYLAR / TECHNICAL DETAILS

TR

- Paslanmaz çelikten imal edilmiştir
- Paslanmaz sac konstrüksiyonu ile uzun ömürlü kolay temizlenebilir ve hijyeniktir
- Cihaz pilotlu ve termokupullu kontrol sistemi bulunmaktadır
- LPG ve NG seçenekleri mevcuttur
- Pişirici hızı yüksek alev veya düşük alev olarak ayarlanabilir

EN

- Made of stainless steel
- Stainless steel sheet construction provides hygiene, long service life and easy of cleaning
- Piloted and thermocouple control system
- LPG and NG options available
- The device speed set up to high or low flame

|   | KOD / CODE | (MM)        | kg | (KW) | € |
|---|------------|-------------|----|------|---|
|  | AIM AGW46  | 400x600x300 | 40 | 10   | - |
|   | AIM AGW86  | 800x600x300 | 67 | 20   | - |

AGI106-D







## TEKNİK DETAYLAR / TECHNICAL DETAILS

TR

- Paslanmaz çelikten imal edilmiştir
- Paslanmaz sac konstrüksiyonu ile uzun ömürlü kolay temizlenebilir ve hijyeniktir
- Kullanıcıya her yönden rahatlık sağlayan ergonomik dizayna sahiptir
- Plate kalınlığı 12 mm. ST52 çelik malzemeden üretilmiştir
- LPG ve NG seçenekleri mevcuttur
- Her biri bağımsız brülörler sayesinde homojen ısı dağılımı sağlanmaktadır

EN

- Made of stainless steel
- Stainless steel sheet construction provides hygiene, long service life and easy of cleaning
- Ergonomic design providing convenience to users in all aspects
- Plate thickness is produced as 12 mm. made of ST52 stainless steel
- LPG and NG options available
- Specially designed tubular burner to ensure homogeneous cooking across plate surfaces

|   | KOD / CODE   | (MM)         | kg | (KW) | € |
|---|--------------|--------------|----|------|---|
|  | AIM AGI46-D  | 400x600x300  | 41 | 4,7  | - |
|  | AIM AGI66-D  | 600x600x300  | 59 | 7,4  | - |
|  | AIM AGI86-D  | 800x600x300  | 71 | 9,4  | - |
|  | AIM AGI106-D | 1000x600x300 | 88 | 13   | - |

GAZLI IZGARALAR - NERVÜRLÜ PLEYT  
GAS GRILLS - RIBBED SURFACE

AGI106-N

GAZLI IZGARALAR - 1/2 NERVÜRLÜ 1/2 DÜZ PLEYT  
GAS GRILLS - 1/2 RIBBED 1/2 SMOOTH SURFACE

AGI106-ND







## TEKNİK DETAYLAR / TECHNICAL DETAILS

TR

- Paslanmaz çelikten imal edilmiştir.
- Paslanmaz sac konstrüksiyonu ile uzun ömürlü kolay temizlenebilir ve hijyeniktir.
- Kullanıcıya her yönden rahatlık sağlayan ergonomik dizayna sahiptir.
- Plate kalınlığı 12 mm. ST52 çelik malzemeden üretilmiştir.
- LPG ve NG seçenekleri mevcuttur.
- Her biri bağımsız brülörler sayesinde homojen ısı dağılımı sağlanmaktadır.

EN

- Made of stainless steel.
- Stainless steel sheet construction provides hygiene, long service life and easy of cleaning.
- Ergonomic design providing convenience to users in all aspects.
- Plate thickness is produced as 12 mm. made of ST52 stainless steel.
- LPG and NG options available.
- Specially designed tubular burner to ensure homogeneous cooking across plate surfaces.

|   | KOD / CODE   | (MM)         | kg | (KW) | € |
|---|--------------|--------------|----|------|---|
|  | AIM AGI46-N  | 400x600x300  | 41 | 4,7  | - |
|  | AIM AGI66-N  | 600x600x300  | 59 | 7,4  | - |
|  | AIM AGI86-N  | 800x600x300  | 71 | 9,4  | - |
|  | AIM AGI106-N | 1000x600x300 | 88 | 13   | - |



## TEKNİK DETAYLAR / TECHNICAL DETAILS

TR

- Paslanmaz çelikten imal edilmiştir.
- Paslanmaz sac konstrüksiyonu ile uzun ömürlü kolay temizlenebilir ve hijyeniktir.
- Kullanıcıya her yönden rahatlık sağlayan ergonomik dizayna sahiptir.
- Plate kalınlığı 12 mm. ST52 çelik malzemeden üretilmiştir.
- LPG ve NG seçenekleri mevcuttur.
- Her biri bağımsız brülörler sayesinde homojen ısı dağılımı sağlanmaktadır.

EN

- Made of stainless steel.
- Stainless steel sheet construction provides hygiene, long service life and easy of cleaning.
- Ergonomic design providing convenience to users in all aspects.
- Plate thickness is produced as 12 mm. made of ST52 stainless steel.
- LPG and NG options available.
- Specially designed tubular burner to ensure homogeneous cooking across plate surfaces.

|   | KOD / CODE    | (MM)         | kg | (KW) | € |
|---|---------------|--------------|----|------|---|
|  | AIM AGI66-ND  | 600x600x300  | 59 | 7,4  | - |
|  | AIM AGI86-ND  | 800x600x300  | 71 | 9,4  | - |
|  | AIM AGI106-ND | 1000x600x300 | 88 | 13   | - |

GAZLI IZGARALAR - DÜZ PLEYT - KROM  
GAS GRILLS - SMOOTH SURFACE - CHROME

CHROME

AGI106-DK

DÜZ PLEYT  
SMOOTH SURFACEGAZLI IZGARALAR - NERVÜRLÜ PLEYT - KROM  
GAS GRILLS - RIBBED SURFACE - CHROME

CHROME

AGI106-NK

NERVÜRLÜ PLEYT  
RIBBED SURFACE





## TEKNİK DETAYLAR / TECHNICAL DETAILS

TR

- Paslanmaz çelikten imal edilmiştir.
- Paslanmaz sac konstrüksiyonu ile uzun ömürlü kolay temizlenebilir ve hijyeniktir.
- Kullanıcıya her yönden rahatlık sağlayan ergonomik dizayna sahiptir.
- Plate kalınlığı 12 mm. ST52 çelik malzemeden üretilmiştir.
- LPG ve NG seçenekleri mevcuttur.
- Her biri bağımsız brülörler sayesinde homojen ısı dağılımı sağlanmaktadır.

EN

- Made of stainless steel.
- Stainless steel sheet construction provides hygiene, long service life and easy of cleaning.
- Ergonomic design providing convenience to users in all aspects.
- Plate thickness is produced as 12 mm. made of ST52 stainless steel.
- LPG and NG options available.
- Specially designed tubular burner to ensure homogeneous cooking across plate surfaces.

|   | KOD / CODE    | (MM)         | kg | (KW) | € |
|---|---------------|--------------|----|------|---|
|  | AIM AGI46-DK  | 400x600x300  | 41 | 4,7  | - |
|  | AIM AGI66-DK  | 600x600x300  | 59 | 7,4  | - |
|  | AIM AGI86-DK  | 800x600x300  | 71 | 9,4  | - |
|  | AIM AGI106-DK | 1000x600x300 | 88 | 13   | - |





## TEKNİK DETAYLAR / TECHNICAL DETAILS

TR

- Paslanmaz çelikten imal edilmiştir.
- Paslanmaz sac konstrüksiyonu ile uzun ömürlü kolay temizlenebilir ve hijyeniktir.
- Kullanıcıya her yönden rahatlık sağlayan ergonomik dizayna sahiptir.
- Plate kalınlığı 12 mm. ST52 çelik malzemeden üretilmiştir.
- LPG ve NG seçenekleri mevcuttur.
- Her biri bağımsız brülörler sayesinde homojen ısı dağılımı sağlanmaktadır.

EN

- Made of stainless steel.
- Stainless steel sheet construction provides hygiene, long service life and easy of cleaning.
- Ergonomic design providing convenience to users in all aspects.
- Plate thickness is produced as 12 mm. made of ST52 stainless steel.
- LPG and NG options available.
- Specially designed tubular burner to ensure homogeneous cooking across plate surfaces.

|   | KOD / CODE    | (MM)         | kg | (KW) | € |
|---|---------------|--------------|----|------|---|
|  | AIM AGI46-NK  | 400x600x300  | 41 | 4,7  | - |
|  | AIM AGI66-NK  | 600x600x300  | 59 | 7,4  | - |
|  | AIM AGI86-NK  | 800x600x300  | 71 | 9,4  | - |
|  | AIM AGI106-NK | 1000x600x300 | 88 | 13   | - |

GAZLI IZGARALAR - 1/2 NERVÜRLÜ 1/2 DÜZ PLEYT - KROM  
GAS GRILLS - 1/2 RIBBED 1/2 SMOOTH SURFACE - CHROME

CHROME

AGI106-NDK



## TEKNİK DETAYLAR / TECHNICAL DETAILS

TR

- Paslanmaz çelikten imal edilmiştir.
- Paslanmaz sac konstrüksiyonu ile uzun ömürlü kolay temizlenebilir ve hijyeniktir.
- Kullanıcıya her yönden rahatlık sağlayan ergonomik dizayna sahiptir.
- Plate kalınlığı 12 mm. ST52 çelik malzemeden üretilmiştir.
- LPG ve NG seçenekleri mevcuttur.
- Her biri bağımsız brülörler sayesinde homojen ısı dağılımı sağlanmaktadır.

EN

- Made of stainless steel.
- Stainless steel sheet construction provides hygiene, long service life and easy of cleaning.
- Ergonomic design providing convenience to users in all aspects.
- Plate thickness is produced as 12 mm. made of ST52 stainless steel.
- LPG and NG options available.
- Specially designed tubular burner to ensure homogeneous cooking across plate surfaces.

|  | KOD / CODE     | (MM)         | kg | (KW) | € |
|--|----------------|--------------|----|------|---|
|  | AIM AGI166-NDK | 600x600x300  | 59 | 7,4  | - |
|  | AIM AGI186-NDK | 800x600x300  | 71 | 9,4  | - |
|  | AIM AGI106-NDK | 1000x600x300 | 88 | 13   | - |

ELEKTRİKLİ IZGARALAR - DÜZ PLEYT  
ELECTRICAL GRILLS - SMOOTH SURFACE

AEI106-D



## TEKNİK DETAYLAR / TECHNICAL DETAILS

TR

- Paslanmaz çelikten imal edilmiştir.
- Paslanmaz sac konstrüksiyonu ile uzun ömürlü kolay temizlenebilir ve hijyeniktir.
- Kullanıcıya her yönden rahatlık sağlayan ergonomik dizayna sahiptir.
- Plate kalınlığı 12 mm. ST52 çelik malzemeden üretilmiştir.
- Cihazda bulunan rezistanslar sayesinde pişirme yüzeyinde homojen bir ısı dağılımı sağlanır.

EN

- Made of stainless steel.
- Stainless steel sheet construction provides hygiene, long service life and easy of cleaning.
- Ergonomic design providing convenience to users in all aspects.
- Plate thickness is produced as 12 mm. made of ST52 stainless steel.
- Specially designed heating elements to ensure homogeneous cooking across plate surfaces.

|  | KOD / CODE   | (MM)         | kg | (KW)              | € |
|--|--------------|--------------|----|-------------------|---|
|  | AIM AEI146-D | 400x600x300  | 41 | 380-410 V<br>4,5  | - |
|  | AIM AEI166-D | 600x600x300  | 59 | 380-410 V<br>6    | - |
|  | AIM AEI186-D | 800x600x300  | 71 | 380-410 V<br>9    | - |
|  | AIM AEI106-D | 1000x600x300 | 88 | 380-410 V<br>10,8 | - |

ELEKTRİKLİ IZGARALAR - NERVÜRLÜ PLEYT  
ELECTRICAL GRILLS - RIBBED SURFACE

AEI106-N

ELEKTRİKLİ IZGARALAR - 1/2 NERVÜRLÜ 1/2 DÜZ PLEYT  
ELECTRICAL GRILLS - 1/2 RIBBED 1/2 SMOOTH SURFACE

AEI106-ND







## TEKNİK DETAYLAR / TECHNICAL DETAILS

TR

- Paslanmaz çelikten imal edilmiştir.
- Paslanmaz sac konstrüksiyonu ile uzun ömürlü kolay temizlenebilir ve hijyeniktir.
- Kullanıcıya her yönden rahatlık sağlayan ergonomik dizayna sahiptir.
- Plate kalınlığı 12 mm. ST52 çelik malzemeden üretilmiştir.
- Cihazda bulunan rezistanslar sayesinde pişirme yüzeyinde homojen bir ısı dağılımı sağlanır.

EN

- Made of stainless steel.
- Stainless steel sheet construction provides hygiene, long service life and easy of cleaning.
- Ergonomic design providing convenience to users in all aspects.
- Plate thickness is produced as 12 mm. made of ST52 stainless steel.
- Specially designed heating elements to ensure homogeneous cooking across plate surfaces.

|   | KOD / CODE   | (MM)         | kg | 380-410 V | (KW) | € |
|---|--------------|--------------|----|-----------|------|---|
|  | AIM AEI46-N  | 400x600x300  | 41 | 380-410 V | 4,5  | - |
|  | AIM AEI66-N  | 600x600x300  | 59 | 380-410 V | 6    | - |
|  | AIM AEI86-N  | 800x600x300  | 71 | 380-410 V | 9    | - |
|  | AIM AEI106-N | 1000x600x300 | 88 | 380-410 V | 10,8 | - |



## TEKNİK DETAYLAR / TECHNICAL DETAILS

TR

- Paslanmaz çelikten imal edilmiştir.
- Paslanmaz sac konstrüksiyonu ile uzun ömürlü kolay temizlenebilir ve hijyeniktir.
- Kullanıcıya her yönden rahatlık sağlayan ergonomik dizayna sahiptir.
- Plate kalınlığı 12 mm. ST52 çelik malzemeden üretilmiştir.
- Cihazda bulunan rezistanslar sayesinde pişirme yüzeyinde homojen bir ısı dağılımı sağlanır.

EN

- Made of stainless steel.
- Stainless steel sheet construction provides hygiene, long service life and easy of cleaning.
- Ergonomic design providing convenience to users in all aspects.
- Plate thickness is produced as 12 mm. made of ST52 stainless steel.
- Specially designed heating elements to ensure homogeneous cooking across plate surfaces.

|   | KOD / CODE    | (MM)         | kg | 380-410 V | (KW) | € |
|---|---------------|--------------|----|-----------|------|---|
|  | AIM AEI66-ND  | 600x600x300  | 59 | 380-410 V | 6    | - |
|  | AIM AEI86-ND  | 800x600x300  | 71 | 380-410 V | 9    | - |
|  | AIM AEI106-ND | 1000x600x300 | 88 | 380-410 V | 10,8 | - |

ELEKTRİKLİ IZGARALAR - DÜZ PLEYT - KROM  
ELECTRICAL GRILLS - SMOOTH SURFACE - CHROME

CHROME

AEI106-DK

DÜZ PLEYT  
SMOOTH SURFACE









## TEKNİK DETAYLAR / TECHNICAL DETAILS

TR

- Paslanmaz çelikten imal edilmiştir.
- Paslanmaz sac konstrüksiyonu ile uzun ömürlü kolay temizlenebilir ve hijyeniktir.
- Kullanıcıya her yönden rahatlık sağlayan ergonomik dizayna sahiptir.
- Plate kalınlığı 12 mm. ST52 çelik malzemeden üretilmiştir.
- Cihazda bulunan rezistanslar sayesinde pişirme yüzeyinde homojen bir ısı dağılımı sağlanır.

EN

- Made of stainless steel.
- Stainless steel sheet construction provides hygiene, long service life and easy of cleaning.
- Ergonomic design providing convenience to users in all aspects.
- Plate thickness is produced as 12 mm. made of ST52 stainless steel.
- Specially designed heating elements to ensure homogeneous cooking across plate surfaces.

|   | KOD / CODE    |  (MM) |  kg |  |  (KW) | € |
|---|---------------|--|--|---|--|---|
|  | AIM AEI46-DK  | 400x600x300  | 41   | 380-410 V   | 4,5  | - |
|  | AIM AEI66-DK  | 600x600x300  | 59   | 380-410 V   | 6  | - |
|  | AIM AEI86-DK  | 800x600x300  | 71   | 380-410 V   | 9  | - |
|  | AIM AEI106-DK | 1000x600x300   | 88   | 380-410 V   | 10,8   | - |

ELEKTRİKLİ IZGARALAR - NERVÜRLÜ PLEYT - KROM  
ELECTRICAL GRILLS - RIBBED SURFACE - CHROME

CHROME

AEI106-NK

NERVÜRLÜ PLEYT  
RIBBED SURFACE









## TEKNİK DETAYLAR / TECHNICAL DETAILS

TR

- Paslanmaz çelikten imal edilmiştir.
- Paslanmaz sac konstrüksiyonu ile uzun ömürlü kolay temizlenebilir ve hijyeniktir.
- Kullanıcıya her yönden rahatlık sağlayan ergonomik dizayna sahiptir.
- Plate kalınlığı 12 mm. ST52 çelik malzemeden üretilmiştir.
- Cihazda bulunan rezistanslar sayesinde pişirme yüzeyinde homojen bir ısı dağılımı sağlanır.

EN

- Made of stainless steel.
- Stainless steel sheet construction provides hygiene, long service life and easy of cleaning.
- Ergonomic design providing convenience to users in all aspects.
- Plate thickness is produced as 12 mm. made of ST52 stainless steel.
- Specially designed heating elements to ensure homogeneous cooking across plate surfaces.

|   | KOD / CODE    |  (MM) |  kg |  |  (KW) | € |
|---|---------------|--|--|---|--|---|
|  | AIM AEI46-NK  | 400x600x300  | 41   | 380-410 V   | 4,5  | - |
|  | AIM AEI66-NK  | 600x600x300  | 59   | 380-410 V   | 6  | - |
|  | AIM AEI86-NK  | 800x600x300  | 71   | 380-410 V   | 9  | - |
|  | AIM AEI106-NK | 1000x600x300   | 88   | 380-410 V   | 10,8   | - |

ELEKTRİKLİ IZGARALAR - 1/2 NERVÜRLÜ 1/2 DÜZ PLEYT - KROM  
ELECTRICAL GRILLS - 1/2 RIBBED 1/2 SMOOTH SURFACE - CHROME

CHROME

AEI106-NDK



## TEKNİK DETAYLAR / TECHNICAL DETAILS

TR

- Paslanmaz çelikten imal edilmiştir.
- Paslanmaz sac konstrüksiyonu ile uzun ömürlü kolay temizlenebilir ve hijyeniktir.
- Kullanıcıya her yönden rahatlık sağlayan ergonomik dizayna sahiptir.
- Plate kalınlığı 12 mm. ST52 çelik malzemeden üretilmiştir.
- LPG ve NG seçenekleri mevcuttur.
- Her biri bağımsız brülörler sayesinde homojen ısı dağılımı sağlanmaktadır.

EN

- Made of stainless steel.
- Stainless steel sheet construction provides hygiene, long service life and easy of cleaning.
- Ergonomic design providing convenience to users in all aspects.
- Plate thickness is produced as 12 mm. made of ST52 stainless steel.
- LPG and NG options available.
- Specially designed tubular burner to ensure homogeneous cooking across plate surfaces.

|  | KOD / CODE     | (MM)         | kg | ⏻         | (KW) | € |
|--|----------------|--------------|----|-----------|------|---|
|  | AIM AEI66-NDK  | 600x600x300  | 59 | 380-410 V | 6    | - |
|  | AIM AEI86-NDK  | 800x600x300  | 71 | 380-410 V | 9    | - |
|  | AIM AEI106-NDK | 1000x600x300 | 88 | 380-410 V | 10,8 | - |

GAZLI LAVATAŞLI IZGARALAR  
GAS LAVASTONE GRILLS

ALG86



## TEKNİK DETAYLAR / TECHNICAL DETAILS

TR

- Paslanmaz çelikten imal edilmiştir.
- Paslanmaz sac konstrüksiyonu ile uzun ömürlü kolay temizlenebilir ve hijyeniktir.
- Kullanıcıya her yönden rahatlık sağlayan ergonomik dizayna sahiptir.
- Yağ haznesi kapasitesi maksimum; E ALG 460 ve E ALG 660 modelinde 2,6 lt., E ALG 860 modelinde 2 x 2,6 lt.
- Cihazda pişirme yapılan ızgara kısmı AISI 304 bükümlü sacdan imal edilmiştir.
- LPG ve NG seçenekleri mevcuttur.

EN

- Made of stainless steel.
- Stainless steel sheet construction provides hygiene, long service life and easy of cleaning.
- Ergonomic design providing convenience to users in all aspects.
- Oil drawer capacity; E ALG 460 ve E ALG 660 models 2,6 lt., E ALG 860 models 2 x 2,6 lt.
- LPG and NG options available.

|  | KOD / CODE | (MM)        | kg | 🔥   | (KW) | € |
|--|------------|-------------|----|-----|------|---|
|  | AIM ALG46  | 400x600x300 | 35 | 6,5 | -    |   |
|  | AIM ALG66  | 600x600x300 | 52 | 9,3 | -    |   |
|  | AIM ALG86  | 800x600x300 | 62 | 13  | -    |   |

ELEKTRİKLİ AMERİKAN IZGARALAR  
ELECTRICAL AMERICAN GRILLS

ALE66





## TEKNİK DETAYLAR / TECHNICAL DETAILS

TR

- Paslanmaz çelikten imal edilmiştir.
- Paslanmaz sac konstrüksiyonu ile uzun ömürlü kolay temizlenebilir ve hijyeniktir.
- Kullanıcıya her yönden rahatlık sağlayan ergonomik dizayna sahiptir.
- Tabanda bulunan hazne içerisindeki su, yağdan kaynaklı duman ve koku oluşumunu minimize eder.
- Cihaz üzerinde bulunan 7 kademeli termostat ile ısıyı istenilen şekilde ayarlayabilme imkanı sağlar.
- Tahliye musluğu bulunmaktadır.
- Cihazdaki rezistanslar yukarı yönlü hareketli olup kolay temizlik imkanı sağlar.

EN

- Made of stainless steel.
- Stainless steel sheet construction provides hygiene, long service life and easy of cleaning.
- Ergonomic design providing convenience to users in all aspects.
- With the 7 steps thermostat on the device, it provides the opportunity to adjust the temperature as requested.
- Equipped drain tap.
- When the resistors are in the upward position, the electricity is cut of with safety switch.

|   | KOD / CODE | (MM)        | kg |           | (KW) | € |
|---|------------|-------------|----|-----------|------|---|
|  | AIM ALE46  | 400x600x300 | 35 | 220-240 V | 2,7  | - |
|   | AIM ALE66  | 600x600x300 | 52 | 380-410 V | 4,5  | - |

ELEKTRİKLİ FRİTÖZLER  
ELECTRICAL FRYERS

AEF86







## TEKNİK DETAYLAR / TECHNICAL DETAILS

TR

- Paslanmaz çelikten imal edilmiştir.
- Paslanmaz sac konstrüksiyonu ile uzun ömürlü kolay temizlenebilir ve hijyeniktir.
- Kullanıcıya her yönden rahatlık sağlayan ergonomik dizayna sahiptir.
- Yağ sıcaklığı 100°C -190°C arasında termostat ile kontrol edilir.
- Cihazda emniyet amaçlı limit termostatu bulunur.
- Cihazdaki rezistanslar yukarı yönlü hareketli olup kolay temizlik imkanı sağlar.

EN

- Made of stainless steel.
- Stainless steel sheet construction provides hygiene, long service life and easy of cleaning.
- Ergonomic design providing convenience to users in all aspects.
- Oil temperature is controlled by thermostat between 100°-190°C.
- Equipped with limiting thermostat.
- When the resistors are in the upward position, the electricity is cut of with safety switch.

|   | KOD / CODE | (MM)        | kg | KAPASİTE / CAPACITY           |           | (KW) | € |
|---|------------|-------------|----|-------------------------------|-----------|------|---|
|  | AIM AEF36  | 300x600x300 | 21 | Min. 4,5 lt<br>Max. 9 lt.     | 380-410 V | 7,5  | - |
|  | AIM AEF46  | 400x600x300 | 23 | Min. 5 lt<br>Max. 12 lt.      | 380-410 V | 9    | - |
|  | AIM AEF66  | 600x600x300 | 36 | Min. 2x4,5 lt<br>Max. 2x9 lt. | 380-410 V | 15   | - |
|  | AIM AEF86  | 800x600x300 | 41 | Min. 2x5 lt<br>Max. 2x12 lt.  | 380-410 V | 18   | - |

AGF86



AWK46





## TEKNİK DETAYLAR / TECHNICAL DETAILS

TR

- Paslanmaz çelikten imal edilmiştir.
- Paslanmaz sac konstrüksiyonu ile uzun ömürlü kolay temizlenebilir ve hijyeniktir.
- Kullanıcıya her yönden rahatlık sağlayan ergonomik dizayna sahiptir.
- Cihazda yüksek kalori sağlayan brülörler kullanılmaktadır.
- Cihaz üzerinde bulunan 7 kademeli termostat ile ısıyı istenilen şekilde ayarlayabilme imkanı sağlar.
- Cihazda pilotlu ve termokupullu kontrol sistemi bulunmaktadır. Termokupul sayesinde alev söndüğünde cihaza gelen gaz otomatik olarak kesilir.

EN

- Made of stainless steel.
- Stainless steel sheet construction provides hygiene, long service life and easy of cleaning.
- Ergonomic design providing convenience to users in all aspects.
- LPG and NG options available
- Specially designed tubular burner to ensure homogeneous cooking across plate surfaces.
- With the 7 steps thermostat on the device, it provides the opportunity to adjust the temperature as requested.

|   | KOD / CODE | (MM)        | kg | KAPASİTE / CAPACITY         | (KW) | € |
|---|------------|-------------|----|-----------------------------|------|---|
|  | AIM AGF46  | 400x600x300 | 25 | Min. 9 lt<br>Max. 11 lt.    | 5,3  | - |
|  | AIM AGF66  | 600x600x300 | 41 | Min. 2x7 lt<br>Max. 2x8 lt. | 10,6 | - |
|  | AIM AGF86  | 800x600x300 | 47 | Min. 2x9 lt<br>Max. 2x9 lt. | 10,6 | - |



## TEKNİK DETAYLAR / TECHNICAL DETAILS

TR

- Paslanmaz çelikten imal edilmiştir.
- Paslanmaz sac konstrüksiyonu ile uzun ömürlü kolay temizlenebilir ve hijyeniktir.
- Cihaz içerisinde yağın süzülmesi için delikli sac bulunmaktadır.
- Cihazda seramik rezistans kullanılmıştır.

EN

- Made of stainless steel.
- Stainless steel sheet construction provides hygiene, long service life and easy of cleaning.
- Equipped with porcelain heater.
- Used for holding chips at perfect serving temperature and condition.

|   | KOD / CODE | (MM)        | kg | KAPASİTE / CAPACITY | (KW)              | € |
|---|------------|-------------|----|---------------------|-------------------|---|
|  | AIM AWK36  | 300x600x300 | 15 | GN 1/2 150          | 220-240 V<br>0,65 | - |
|  | AIM AWK46  | 400x600x300 | 18 | GN 2/3 150          | 220-240 V<br>0,65 | - |

ELEKTRİKLİ BENMARI  
ELECTRICAL BAINMARIE

BN66

ELEKTRİKLİ MAKARNA HAŞLAMALAR  
ELECTRICAL PASTA COOKERS

PC66





## TEKNİK DETAYLAR / TECHNICAL DETAILS

TR

- Paslanmaz çelikten imal edilmiştir.
- Paslanmaz sac konstrüksiyonu ile uzun ömürlü kolay temizlenebilir ve hijyeniktir.
- Cihaz 30°- 90°C aralığında termostat ile kontrol edilir.
- Cihazda kilitli boşaltma vanası sayesinde kullanıcı kontrolü dışında açılıp boşaltma yapılamaz.

EN

- Made of stainless steel.
- Stainless steel sheet construction provides hygiene, long service life and easy of cleaning.
- Ergonomic design providing convenience to users in all aspects.
- The device is controlled by a thermostat in the range of 30°-90°C .

|   | KOD / CODE | (MM)        | kg | KAPASİTE / CAPACITY |           | (KW) | € |
|---|------------|-------------|----|---------------------|-----------|------|---|
|  | AIM BN36   | 300x600x300 | 15 | GN 1/4 + GN 1/2     | 220-240 V | 1,2  | - |
|  | AIM BN46   | 400x600x300 | 24 | GN 1/2 + GN 1/3     | 220-240 V | 1,4  | - |
|  | AIM BN66   | 600x600x300 | 31 | GN 1/1 + GN 1/4 x2  | 220-240 V | 2,1  | - |



## TEKNİK DETAYLAR / TECHNICAL DETAILS

TR

- Paslanmaz çelikten imal edilmiştir.
- Paslanmaz sac konstrüksiyonu ile uzun ömürlü kolay temizlenebilir ve hijyeniktir.
- Cihazda kilitli boşaltma vanası sayesinde kullanıcı kontrolü dışında açılıp boşaltma yapılamaz.
- Cihazda temiz su girişi musluğu ve taşan su tahliyesi mevcuttur.
- Cihazda enerji regülatörü ile ısı kontrolü sağlanır.
- Aşırı ısınmaya karşı limit termostat bulunur.

EN

- Made of stainless steel.
- Stainless steel sheet construction provides hygiene long service life and easy of cleaning.
- The device has a locked drain valve.It cannot be turned on/off without user control.
- The device has a clean water inlet tap and an overflowing water drain.
- Heat control is provided by the energy regulator in the device.
- It has a heat regulator against over heating.

|   | KOD / CODE | (MM)        | kg |           | (KW) | € |
|---|------------|-------------|----|-----------|------|---|
|  | AIM PC36   | 300x600x300 | 19 | 220-240 V | 3    | - |
|  | AIM PC46   | 400x600x300 | 23 | 380-410 V | 5    | - |
|  | AIM PC66   | 600x600x300 | 28 | 380-410 V | 7,5  | - |

ELEKTRİKLİ SETALTI FIRINLAR  
ELECTRICAL UNDERCOUNTER OVENS

SFEF106

## TEKNİK DETAYLAR / TECHNICAL DETAILS

TR

- Paslanmaz çelikten imal edilmiştir.
- Paslanmaz sac konstrüksiyonu ile uzun ömürlü kolay temizlenebilir ve hijyeniktir.
- Cihazda bulunan rezistanslar 50°-300°C aralığında çalışır. isteğe göre ayrı ayrı kontrol edilebilir.
- ST modellerinde; cihazın tabanında ısıyı homojen olarak dağıtmak için 10 mm. kalınlığında ST Serisi çelik plate bulunmaktadır.
- F modellerinde; fırında iç hacmi homojen olarak ısıtan AC fan bulunmaktadır.
- Ürün üzerinde aynı seriden farklı ürünler konumlandırılabilir.
- Fırın içerisinde 2 adet 530 x 400 mm. tel ızgara bulunmaktadır.

EN

- Made of stainless Steel
- Stainless steel sheet construction provides hygiene, long service life and easy of cleaning.
- The resistances in the device operate in the range of 50°-300°C degrees. It can be individually controlled optionally.
- In the ST model, in order to homogenize the heat at the base of the device, 10mm thick ST model steel is produced.
- There is an AC fan that heats the internal volume homogeneously in F models.
- Different products from the same series can be put on the product.
- There are 2 pieces 530x400 mm wire grids in the oven.

| KOD / CODE  | (MM)         | kg | KAPASİTE / CAPACITY | (KW)      | €   |   |
|-------------|--------------|----|---------------------|-----------|-----|---|
| AIM SSEF86  | 800x600x550  | 35 | GN 1/1              | 380-415 V | 4,3 | - |
| AIM SFEF86  | 800x600x550  | 35 | GN 1/1              | 220-240 V | 2,6 | - |
| AIM SSEF106 | 1000x600x550 | 45 | GN 1/1              | 380-415 V | 4,3 | - |
| AIM SFEF106 | 1000x600x550 | 45 | GN 1/1              | 220-240 V | 2,6 | - |

GAZLI SETALTI FIRINLAR  
GAS UNDERCOUNTER OVENS

SGF106

## TEKNİK DETAYLAR / TECHNICAL DETAILS

TR

- Paslanmaz çelikten imal edilmiştir.
- Paslanmaz sac konstrüksiyonu ile uzun ömürlü kolay temizlenebilir ve hijyeniktir.
- Fırında sıcaklık 60°-300° C aralığında bir adet termostatlı gaz musluğu ile kontrol edilir.
- Cihazda pilotlu ve termokupullu kontrol sistemi bulunmaktadır. Termokupul sayesinde alev söndüğünde cihaza gelen gaz otomatik olarak kesilir.
- LPG ve NG seçenekleri mevcuttur.

EN

- Made of stainless Steel
- Stainless steel sheet construction provides hygiene, long service life and easy of cleaning.
- The temperature in the oven is controlled by a thermostatic gas tap in the range of 60°-300°C degrees.
- The device has a pilot and thermocouple control system. When the flame goes out with the thermocouple, the gas coming to the device is automatically cut off.
- LPG and NG options available.

| KOD / CODE | (MM)         | kg | KAPASİTE / CAPACITY | (KW) | € |
|------------|--------------|----|---------------------|------|---|
| AIM SGF86  | 800x600x550  | 42 | GN 1/1              | 4,5  | - |
| AIM SGF106 | 1000x600x550 | 50 | GN 1/1              | 4,5  | - |



NW66





## TEKNİK DETAYLAR / TECHNICAL DETAILS

## TR

- Paslanmaz çelikten imal edilmiştir.
- Paslanmaz sac konstrüksiyonu ile uzun ömürlü kolay temizlenebilir ve hijyeniktir.
- Kullanıcıya her açıdan kolaylık sağlayan ergonomik tasarım.

## EN

- Made of stainless steel.
- Stainless steel sheet construction provides hygiene, long service life and easy of cleaning.
- Ergonomic design providing convenience to users in all aspects.

|   | KOD / CODE |  (MM) |  kg | € |
|---|------------|--|---|---|
|  | AIM NW36   | 300x600x300  | 9   | - |
|  | AIM NW46   | 400x600x300  | 13  | - |
|  | AIM NW66   | 600x600x300  | 17  | - |



UC106







## TEKNİK DETAYLAR / TECHNICAL DETAILS

## TR

- Paslanmaz çelikten imal edilmiştir.
- Paslanmaz sac konstrüksiyonu ile uzun ömürlü kolay temizlenebilir ve hijyeniktir.
- Kapılar çift cidarlıdır.
- Setaltı tezgahların üzerinde bulunan pimler cihazların altındaki yuvalara göre tasarlanmış olup ürünlerin tek parça olarak görünmesini sağlar.

## EN

- Made of stainless steel.
- Stainless steel sheet construction provides hygiene, long service life and easy of cleaning.
- Double-wall walled.
- Pins on the undercounter cabinets are designed for the top equipment so that the products have a uniform look.

|   | KOD / CODE |  (MM) |  kg | € |
|---|------------|--|--|---|
|  | AIM UC36   | 300x600x550  | 12   | - |
|  | AIM UC46   | 400x600x550  | 14   | - |
|  | AIM UC66   | 600x600x550  | 18   | - |
|  | AIM UC86   | 800x600x550  | 23   | - |
|  | AIM UC106  | 1000x600x550   | 27   | - |

# 730 SERİ PIŞİRME EKİPMANLARI



## 730 SERIES HOT LINE



AGO127









## TEKNİK DETAYLAR / TECHNICAL DETAILS

TR

- Paslanmaz çelikten imal edilmiştir
- Paslanmaz sac konstrüksiyonu ile uzun ömürlü kolay temizlenebilir ve hijyeniktir
- Cihaz pilotlu ve termokupullu kontrol sistemi bulunmaktadır.
- LPG ve NG seçenekleri mevcuttur
- Pişirici hızı yüksek alev veya düşük alev olarak ayarlanabilir

EN

- Made of stainless steel
- Stainless steel sheet construction provides hygiene, long service life and easy of cleaning
- Piloted and thermocouple control system
- LPG and NG options available
- The device speed set up to high or low flame

|   | KOD / CODE |  (MM) |  kg |  (KW) | € |
|---|------------|--|--|--|---|
|  | AIM AGO47  | 400x730x300  | 26   | 11,5   | - |
|   | AIM AGO87  | 800x730x300  | 42   | 23   | - |
|   | AIM AGO127 | 1200x730x300   | 72   | 34,5   | - |

AEO127-Y

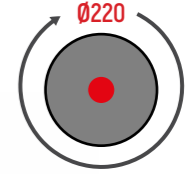







## TEKNİK DETAYLAR / TECHNICAL DETAILS

TR

- Paslanmaz çelikten imal edilmiştir
- Paslanmaz sac konstrüksiyonu ile uzun ömürlü kolay temizlenebilir ve hijyeniktir
- Cihaz üzerinde bulunan 6 kademeli termostat ile ısıyı istenilen şekilde ayarlayabilme imkanı sağlar

EN

- Made of stainless steel
- Stainless steel sheet construction provides hygiene, long service life and easy of cleaning
- With the 6 steps thermostat on the device, it provides the opportunity to adjust the temperature as requested

|   | KOD / CODE   |  (MM) |  kg |  |  (KW) | € |
|---|--------------|--|--|---|--|---|
|  | AIM AEO47-Y  | 400x730x300  | 26   | 380-410 V   | 5,2  | - |
|  | AIM AEO87-Y  | 800x730x300  | 42   | 380-410 V   | 10,4   | - |
|  | AIM AEO127-Y | 1200x730x300   | 53   | 380-410 V   | 15,6   | - |

ELEKTRİKLİ OCAKLAR - KARE PLEYT  
ELECTRIC COOKERS - SQUARE

AEO127-K

300

300

GAZLI WOK OCAKLAR  
GAS WOK COOKERS

AGW87







## TEKNİK DETAYLAR / TECHNICAL DETAILS

TR

- Paslanmaz çelikten imal edilmiştir
- Paslanmaz sac konstrüksiyonu ile uzun ömürlü kolay temizlenebilir ve hijyeniktir
- Cihaz üzerinde bulunan 6 kademeli termostat ile ısıyı istenilen şekilde ayarlayabilme imkanı sağlar

EN

- Made of stainless steel
- Stainless steel sheet construction provides hygiene, long service life and easy of cleaning
- With the 6 steps thermostat on the device, it provides the opportunity to adjust the temperature as requested

|   | KOD / CODE   | <br>[MM] | <br>kg | <br>V | <br>[KW] | € |
|---|--------------|---|---|--|---|---|
|  | AIM AEO47-K  | 400x730x300   | 26  | 380-410 V  | 5,2   | - |
|   | AIM AEO87-K  | 800x730x300   | 42  | 380-410 V  | 10,4  | - |
|   | AIM AEO127-K | 1200x730x300  | 53  | 380-410 V  | 15,6  | - |





## TEKNİK DETAYLAR / TECHNICAL DETAILS

TR

- Paslanmaz çelikten imal edilmiştir
- Paslanmaz sac konstrüksiyonu ile uzun ömürlü kolay temizlenebilir ve hijyeniktir
- Cihaz pilotlu ve termokupullu kontrol sistemi bulunmaktadır
- LPG ve NG seçenekleri mevcuttur
- Pişirici hızı yüksek alev veya düşük alev olarak ayarlanabilir

EN

- Made of stainless steel
- Stainless steel sheet construction provides hygiene, long service life and easy of cleaning
- Piloted and thermocouple control system
- LPG and NG options available
- The device speed set up to high or low flame

|   | KOD / CODE | <br>[MM] | <br>kg | <br>[KW] | € |
|---|------------|---|---|---|---|
|  | AIM AGW47  | 400x730x300   | 38  | 10  | - |
|  | AIM AGW87  | 800x730x300   | 50  | 20  | - |

GAZLI IZGARALAR - DÜZ PLEYT  
GAS GRILLS - SMOOTH SURFACEGAZLI IZGARALAR - NERVÜRLÜ PLEYT  
GAS GRILLS - RIBBED SURFACE





## TEKNİK DETAYLAR / TECHNICAL DETAILS

TR

- Paslanmaz çelikten imal edilmiştir
- Paslanmaz sac konstrüksiyonu ile uzun ömürlü kolay temizlenebilir ve hijyeniktir
- Kullanıcıya her yönden rahatlık sağlayan ergonomik dizayna sahiptir
- Plate kalınlığı 12 mm. ST52 çelik malzemeden üretilmiştir
- LPG ve NG seçenekleri mevcuttur
- Her biri bağımsız brülörler sayesinde homojen ısı dağılımı sağlanmaktadır

EN

- Made of stainless steel
- Stainless steel sheet construction provides hygiene, long service life and easy of cleaning
- Ergonomic design providing convenience to users in all aspects
- Plate thickness is produced as 12 mm. made of ST52 stainless steel
- LPG and NG options available
- Specially designed tubular burner to ensure homogeneous cooking across plate surfaces

|  | KOD / CODE   | (MM)         | kg  | (KW) | € |
|--|--------------|--------------|-----|------|---|
|  | AIM AGI47-D  | 400x730x300  | 47  | 6,3  | - |
|  | AIM AGI67-D  | 600x730x300  | 53  | 9    | - |
|  | AIM AGI87-D  | 800x730x300  | 78  | 12,6 | - |
|  | AIM AGI127-D | 1200x730x300 | 125 | 18,9 | - |





## TEKNİK DETAYLAR / TECHNICAL DETAILS

TR

- Paslanmaz çelikten imal edilmiştir.
- Paslanmaz sac konstrüksiyonu ile uzun ömürlü kolay temizlenebilir ve hijyeniktir.
- Kullanıcıya her yönden rahatlık sağlayan ergonomik dizayna sahiptir.
- Plate kalınlığı 12 mm. ST52 çelik malzemeden üretilmiştir.
- LPG ve NG seçenekleri mevcuttur.
- Her biri bağımsız brülörler sayesinde homojen ısı dağılımı sağlanmaktadır.

EN

- Made of stainless steel.
- Stainless steel sheet construction provides hygiene, long service life and easy of cleaning.
- Ergonomic design providing convenience to users in all aspects.
- Plate thickness is produced as 12 mm. made of ST52 stainless steel.
- LPG and NG options available.
- Specially designed tubular burner to ensure homogeneous cooking across plate surfaces.

|   | KOD / CODE   | (MM)         | kg  | (KW) | € |
|---|--------------|--------------|-----|------|---|
|  | AIM AGI47-N  | 400x730x300  | 47  | 6,3  | - |
|  | AIM AGI67-N  | 600x730x300  | 53  | 9    | - |
|  | AIM AGI87-N  | 800x730x300  | 78  | 12,6 | - |
|  | AIM AGI127-N | 1200x730x300 | 125 | 18,9 | - |

GAZLI IZGARALAR - 1/2 NERVÜRLÜ 1/2 DÜZ PLEYT  
GAS GRILLS - 1/2 RIBBED 1/2 SMOOTH SURFACEGAZLI IZGARALAR - DÜZ PLEYT - KROM  
GAS GRILLS - SMOOTH SURFACE - CHROME

## TEKNİK DETAYLAR / TECHNICAL DETAILS

TR

- Paslanmaz çelikten imal edilmiştir.
- Paslanmaz sac konstrüksiyonu ile uzun ömürlü kolay temizlenebilir ve hijyeniktir.
- Kullanıcıya her yönden rahatlık sağlayan ergonomik dizayna sahiptir.
- Plate kalınlığı 12 mm. ST52 çelik malzemeden üretilmiştir.
- LPG ve NG seçenekleri mevcuttur.
- Her biri bağımsız brülörler sayesinde homojen ısı dağılımı sağlanmaktadır.

EN

- Made of stainless steel.
- Stainless steel sheet construction provides hygiene, long service life and easy of cleaning.
- Ergonomic design providing convenience to users in all aspects.
- Plate thickness is produced as 12 mm. made of ST52 stainless steel.
- LPG and NG options available.
- Specially designed tubular burner to ensure homogeneous cooking across plate surfaces.

|  | KOD / CODE    | (MM)         | kg  | (KW) | € |
|--|---------------|--------------|-----|------|---|
|  | AIM AGI167-ND | 600x730x300  | 53  | 9    | - |
|  | AIM AGI187-ND | 800x730x300  | 78  | 12,6 | - |
|  | AIM AGI127-ND | 1200x730x300 | 125 | 18,9 | - |

## TEKNİK DETAYLAR / TECHNICAL DETAILS

TR

- Paslanmaz çelikten imal edilmiştir.
- Paslanmaz sac konstrüksiyonu ile uzun ömürlü kolay temizlenebilir ve hijyeniktir.
- Kullanıcıya her yönden rahatlık sağlayan ergonomik dizayna sahiptir.
- Plate kalınlığı 12 mm. ST52 çelik malzemeden üretilmiştir.
- LPG ve NG seçenekleri mevcuttur.
- Her biri bağımsız brülörler sayesinde homojen ısı dağılımı sağlanmaktadır.

EN

- Made of stainless steel.
- Stainless steel sheet construction provides hygiene, long service life and easy of cleaning.
- Ergonomic design providing convenience to users in all aspects.
- Plate thickness is produced as 12 mm. made of ST52 stainless steel.
- LPG and NG options available.
- Specially designed tubular burner to ensure homogeneous cooking across plate surfaces.

|  | KOD / CODE    | (MM)         | kg  | (KW) | € |
|--|---------------|--------------|-----|------|---|
|  | AIM AGI47-DK  | 400x730x300  | 47  | 6,3  | - |
|  | AIM AGI67-DK  | 600x730x300  | 53  | 9    | - |
|  | AIM AGI87-DK  | 800x730x300  | 78  | 12,6 | - |
|  | AIM AGI127-DK | 1200x730x300 | 125 | 18,9 | - |

GAZLI IZGARALAR - NERVÜRLÜ PLEYT - KROM  
GAS GRILLS - RIBBED SURFACE - CHROME

CHROME

AGI127-NK

NERVÜRLÜ PLEYT  
RIBBED SURFACEGAZLI IZGARALAR - 1/2 NERVÜRLÜ 1/2 DÜZ PLEYT - KROM  
GAS GRILLS - 1/2 RIBBED 1/2 SMOOTH SURFACE - CHROME

CHROME

AGI127-NDK

1/2 NERVÜRLÜ 1/2 DÜZ PLEYT  
1/2 RIBBED 1/2 SMOOTH SURFACE







## TEKNİK DETAYLAR / TECHNICAL DETAILS

TR

- Paslanmaz çelikten imal edilmiştir.
- Paslanmaz sac konstrüksiyonu ile uzun ömürlü kolay temizlenebilir ve hijyeniktir.
- Kullanıcıya her yönden rahatlık sağlayan ergonomik dizayna sahiptir.
- Plate kalınlığı 12 mm. ST52 çelik malzemeden üretilmiştir.
- LPG ve NG seçenekleri mevcuttur.
- Her biri bağımsız brülörler sayesinde homojen ısı dağılımı sağlanmaktadır.

EN

- Made of stainless steel.
- Stainless steel sheet construction provides hygiene, long service life and easy of cleaning.
- Ergonomic design providing convenience to users in all aspects.
- Plate thickness is produced as 12 mm. made of ST52 stainless steel.
- LPG and NG options available.
- Specially designed tubular burner to ensure homogeneous cooking across plate surfaces.

|  | KOD / CODE    |  (MM) |  kg |  (KW) | € |
|--|---------------|--|--|--|---|
|  | AIM AGI47-NK  | 400x730x300  | 47   | 6,3  | - |
|  | AIM AGI67-NK  | 600x730x300  | 53   | 9  | - |
|  | AIM AGI87-NK  | 800x730x300  | 78   | 12,6   | - |
|  | AIM AGI127-NK | 1200x730x300   | 125  | 18,9   | - |







## TEKNİK DETAYLAR / TECHNICAL DETAILS

TR

- Paslanmaz çelikten imal edilmiştir.
- Paslanmaz sac konstrüksiyonu ile uzun ömürlü kolay temizlenebilir ve hijyeniktir.
- Kullanıcıya her yönden rahatlık sağlayan ergonomik dizayna sahiptir.
- Plate kalınlığı 12 mm. ST52 çelik malzemeden üretilmiştir.
- LPG ve NG seçenekleri mevcuttur.
- Her biri bağımsız brülörler sayesinde homojen ısı dağılımı sağlanmaktadır.

EN

- Made of stainless steel.
- Stainless steel sheet construction provides hygiene, long service life and easy of cleaning.
- Ergonomic design providing convenience to users in all aspects.
- Plate thickness is produced as 12 mm. made of ST52 stainless steel.
- LPG and NG options available.
- Specially designed tubular burner to ensure homogeneous cooking across plate surfaces.

|   | KOD / CODE     |  (MM) |  kg |  (KW) | € |
|---|----------------|--|--|--|---|
|  | AIM AGI67-NDK  | 600x730x300  | 53   | 9  | - |
|  | AIM AGI87-NDK  | 800x730x300  | 78   | 12,6   | - |
|  | AIM AGI127-NDK | 1200x730x300   | 125  | 18,9   | - |

ELEKTRİKLİ IZGARALAR - DÜZ PLEYT  
ELECTRICAL GRILLS - SMOOTH SURFACEELEKTRİKLİ IZGARALAR - NERVÜRLÜ PLEYT  
ELECTRICAL GRILLS - RIBBED SURFACE





## TEKNİK DETAYLAR / TECHNICAL DETAILS

TR

- Paslanmaz çelikten imal edilmiştir.
- Paslanmaz sac konstrüksiyonu ile uzun ömürlü kolay temizlenebilir ve hijyeniktir.
- Kullanıcıya her yönden rahatlık sağlayan ergonomik dizayna sahiptir.
- Plate kalınlığı 12 mm. ST52 çelik malzemeden üretilmiştir.
- Cihazda bulunan rezistanslar sayesinde pişirme yüzeyinde homojen bir ısı dağılımı sağlanır.

EN

- Made of stainless steel.
- Stainless steel sheet construction provides hygiene, long service life and easy of cleaning.
- Ergonomic design providing convenience to users in all aspects.
- Plate thickness is produced as 12 mm. made of ST52 stainless steel.
- Specially designed heating elements to ensure homogeneous cooking across plate surfaces.

|  | KOD / CODE   | (MM)         | kg  |           | (KW) | € |
|--|--------------|--------------|-----|-----------|------|---|
|  | AIM AEI47-D  | 400x730x300  | 47  | 380-410 V | 5,1  | - |
|  | AIM AEI67-D  | 600x730x300  | 53  | 380-410 V | 6,8  | - |
|  | AIM AEI87-D  | 800x730x300  | 78  | 380-410 V | 10,2 | - |
|  | AIM AEI127-D | 1200x730x300 | 125 | 380-410 V | 15,3 | - |





## TEKNİK DETAYLAR / TECHNICAL DETAILS

TR

- Paslanmaz çelikten imal edilmiştir.
- Paslanmaz sac konstrüksiyonu ile uzun ömürlü kolay temizlenebilir ve hijyeniktir.
- Kullanıcıya her yönden rahatlık sağlayan ergonomik dizayna sahiptir.
- Plate kalınlığı 12 mm. ST52 çelik malzemeden üretilmiştir.
- Cihazda bulunan rezistanslar sayesinde pişirme yüzeyinde homojen bir ısı dağılımı sağlanır.

EN

- Made of stainless steel.
- Stainless steel sheet construction provides hygiene, long service life and easy of cleaning.
- Ergonomic design providing convenience to users in all aspects.
- Plate thickness is produced as 12 mm. made of ST52 stainless steel.
- Specially designed heating elements to ensure homogeneous cooking across plate surfaces.

|   | KOD / CODE   | (MM)         | kg  |           | (KW) | € |
|---|--------------|--------------|-----|-----------|------|---|
|  | AIM AEI47-N  | 400x730x300  | 47  | 380-410 V | 5,1  | - |
|  | AIM AEI67-N  | 600x730x300  | 53  | 380-410 V | 6,8  | - |
|  | AIM AEI87-N  | 800x730x300  | 78  | 380-410 V | 10,2 | - |
|  | AIM AEI127-N | 1200x730x300 | 125 | 380-410 V | 15,3 | - |

ELEKTRİKLİ IZGARALAR - 1/2 NERVÜRLÜ 1/2 DÜZ PLEYT  
ELECTRICAL GRILLS - 1/2 RIBBED 1/2 SMOOTH SURFACE

AEI127-ND

1/2 NERVÜRLÜ 1/2 DÜZ PLEYT  
1/2 RIBBED 1/2 SMOOTH SURFACEELEKTRİKLİ IZGARALAR - DÜZ PLEYT - KROM  
ELECTRICAL GRILLS - SMOOTH SURFACE - CHROME

CHROME



AEI127-DK

DÜZ PLEYT  
SMOOTH SURFACE



## TEKNİK DETAYLAR / TECHNICAL DETAILS

TR

- Paslanmaz çelikten imal edilmiştir.
- Paslanmaz sac konstrüksiyonu ile uzun ömürlü kolay temizlenebilir ve hijyeniktir.
- Kullanıcıya her yönden rahatlık sağlayan ergonomik dizayna sahiptir.
- Plate kalınlığı 12 mm. ST52 çelik malzemeden üretilmiştir.
- Cihazda bulunan rezistanslar sayesinde pişirme yüzeyinde homojen bir ısı dağılımı sağlanır.

EN

- Made of stainless steel.
- Stainless steel sheet construction provides hygiene, long service life and easy of cleaning.
- Ergonomic design providing convenience to users in all aspects.
- Plate thickness is produced as 12 mm. made of ST52 stainless steel.
- Specially designed heating elements to ensure homogeneous cooking across plate surfaces.

|  | KOD / CODE    | (MM)         | kg  | 380-410 V | (KW) | € |
|--|---------------|--------------|-----|-----------|------|---|
|  | AIM AEI167-ND | 600x730x300  | 53  | 380-410 V | 6,8  | - |
|  | AIM AEI187-ND | 800x730x300  | 78  | 380-410 V | 10,2 | - |
|  | AIM AEI127-ND | 1200x730x300 | 125 | 380-410 V | 15,3 | - |





## TEKNİK DETAYLAR / TECHNICAL DETAILS

TR

- Paslanmaz çelikten imal edilmiştir.
- Paslanmaz sac konstrüksiyonu ile uzun ömürlü kolay temizlenebilir ve hijyeniktir.
- Kullanıcıya her yönden rahatlık sağlayan ergonomik dizayna sahiptir.
- Plate kalınlığı 12 mm. ST52 çelik malzemeden üretilmiştir.
- Cihazda bulunan rezistanslar sayesinde pişirme yüzeyinde homojen bir ısı dağılımı sağlanır.

EN

- Made of stainless steel.
- Stainless steel sheet construction provides hygiene, long service life and easy of cleaning.
- Ergonomic design providing convenience to users in all aspects.
- Plate thickness is produced as 12 mm. made of ST52 stainless steel.
- Specially designed heating elements to ensure homogeneous cooking across plate surfaces.

|   | KOD / CODE    | (MM)         | kg  | 380-410 V | (KW) | € |
|---|---------------|--------------|-----|-----------|------|---|
|  | AIM AEI47-DK  | 400x730x300  | 47  | 380-410 V | 5,1  | - |
|  | AIM AEI67-DK  | 600x730x300  | 53  | 380-410 V | 6,8  | - |
|  | AIM AEI87-DK  | 800x730x300  | 78  | 380-410 V | 10,2 | - |
|  | AIM AEI127-DK | 1200x730x300 | 125 | 380-410 V | 15,3 | - |

ELEKTRİKLİ IZGARALAR - NERVÜRLÜ PLEYT - KROM  
ELECTRICAL GRILLS - RIBBED SURFACE - CHROME

CHROME

AEI127-NK

NERVÜRLÜ PLEYT  
RIBBED SURFACEELEKTRİKLİ IZGARALAR - 1/2 NERVÜRLÜ 1/2 DÜZ PLEYT - KROM  
ELECTRICAL GRILLS - 1/2 RIBBED 1/2 SMOOTH SURFACE - CHROME

CHROME

AEI127-NDK

1/2 NERVÜRLÜ 1/2 DÜZ PLEYT  
1/2 RIBBED 1/2 SMOOTH SURFACE





## TEKNİK DETAYLAR / TECHNICAL DETAILS

TR

- Paslanmaz çelikten imal edilmiştir.
- Paslanmaz sac konstrüksiyonu ile uzun ömürlü kolay temizlenebilir ve hijyeniktir.
- Kullanıcıya her yönden rahatlık sağlayan ergonomik dizayna sahiptir.
- Plate kalınlığı 12 mm. ST52 çelik malzemeden üretilmiştir.
- Cihazda bulunan rezistanslar sayesinde pişirme yüzeyinde homojen bir ısı dağılımı sağlanır.

EN

- Made of stainless steel.
- Stainless steel sheet construction provides hygiene, long service life and easy of cleaning.
- Ergonomic design providing convenience to users in all aspects.
- Plate thickness is produced as 12 mm. made of ST52 stainless steel.
- Specially designed heating elements to ensure homogeneous cooking across plate surfaces.

|  | KOD / CODE    | [MM]         | kg  | 380-410 V | (KW) | €     |
|--|---------------|--------------|-----|-----------|------|-------|
|  | AIM AEI47-NK  | 400x730x300  | 47  | 380-410 V | 5,1  | 1430  |
|  | AIM AEI67-NK  | 600x730x300  | 53  | 380-410 V | 6,8  | 1.831 |
|  | AIM AEI87-NK  | 800x730x300  | 78  | 380-410 V | 10,2 | 2.242 |
|  | AIM AEI127-NK | 1200x730x300 | 125 | 380-410 V | 15,3 | 2.927 |



## TEKNİK DETAYLAR / TECHNICAL DETAILS

TR

- Paslanmaz çelikten imal edilmiştir.
- Paslanmaz sac konstrüksiyonu ile uzun ömürlü kolay temizlenebilir ve hijyeniktir.
- Kullanıcıya her yönden rahatlık sağlayan ergonomik dizayna sahiptir.
- Plate kalınlığı 12 mm. ST52 çelik malzemeden üretilmiştir.
- LPG ve NG seçenekleri mevcuttur.
- Her biri bağımsız brülörler sayesinde homojen ısı dağılımı sağlanmaktadır.

EN

- Made of stainless steel.
- Stainless steel sheet construction provides hygiene, long service life and easy of cleaning.
- Ergonomic design providing convenience to users in all aspects.
- Plate thickness is produced as 12 mm. made of ST52 stainless steel.
- LPG and NG options available.
- Specially designed tubular burner to ensure homogeneous cooking across plate surfaces.

|   | KOD / CODE     | [MM]         | kg  | 380-410 V | (KW) | €     |
|---|----------------|--------------|-----|-----------|------|-------|
|  | AIM AEI67-NDK  | 600x730x300  | 53  | 380-410 V | 6,8  | 1.797 |
|  | AIM AEI87-NDK  | 800x730x300  | 78  | 380-410 V | 10,2 | 2.197 |
|  | AIM AEI127-NDK | 1200x730x300 | 125 | 380-410 V | 15,3 | 2.892 |

GAZLI LAVATAŞLI IZGARALAR  
GAS LAVASTONE GRILLS

ALG127

GAZLI AMERİKAN IZGARALAR  
GAS AMERICAN GRILLS

AAG127







## TEKNİK DETAYLAR / TECHNICAL DETAILS

TR

- Paslanmaz çelikten imal edilmiştir.
- Paslanmaz sac konstrüksiyonu ile uzun ömürlü kolay temizlenebilir ve hijyeniktir.
- Kullanıcıya her yönden rahatlık sağlayan ergonomik dizayna sahiptir.
- Cihazda pişirme yapılan ızgara kısmı dökümden imal edilmiştir.
- LPG ve NG seçenekleri mevcuttur.

EN

- Made of stainless steel.
- Stainless steel sheet construction provides hygiene, long service life and easy of cleaning.
- Ergonomic design providing convenience to users in all aspects.
- Cooking surface made of cast iron.
- LPG and NG options available.

|   | KOD / CODE | (MM)         | kg  | (KW) | € |
|---|------------|--------------|-----|------|---|
|  | AIM ALG47  | 400x730x300  | 57  | 5    | - |
|  | AIM ALG67  | 600x730x300  | 75  | 5,5  | - |
|  | AIM ALG87  | 800x730x300  | 96  | 10   | - |
|  | AIM ALG127 | 1200x730x300 | 143 | 15   | - |





## TEKNİK DETAYLAR / TECHNICAL DETAILS

TR

- Paslanmaz çelikten imal edilmiştir.
- Paslanmaz sac konstrüksiyonu ile uzun ömürlü kolay temizlenebilir ve hijyeniktir.
- Kullanıcıya her yönden rahatlık sağlayan ergonomik dizayna sahiptir.
- Cihazda pişirme yapılan ızgara kısmı dökümden imal edilmiştir.
- LPG ve NG seçenekleri mevcuttur.

EN

- Made of stainless steel.
- Stainless steel sheet construction provides hygiene, long service life and easy of cleaning.
- Ergonomic design providing convenience to users in all aspects.
- Cooking surface made of cast iron.
- LPG and NG options available.

|   | KOD / CODE | (MM)         | kg  | (KW) | € |
|---|------------|--------------|-----|------|---|
|  | AIM AAG47  | 400x730x300  | 57  | 9    | - |
|  | AIM AAG67  | 600x730x300  | 75  | 12   | - |
|  | AIM AAG87  | 800x730x300  | 96  | 18   | - |
|  | AIM AAG127 | 1200x730x300 | 143 | 24   | - |

ELEKTRİKLİ AMERİKAN IZGARALAR  
ELECTRICAL AMERICAN GRILLS

ALE67

ELEKTRİKLİ FRİTÖZLER  
ELECTRICAL FRYERS

AEF87









## TEKNİK DETAYLAR / TECHNICAL DETAILS

TR

- Paslanmaz çelikten imal edilmiştir.
- Paslanmaz sac konstrüksiyonu ile uzun ömürlü kolay temizlenebilir ve hijyeniktir.
- Kullanıcıya her yönden rahatlık sağlayan ergonomik dizayna sahiptir.
- Tabanda bulunan hazne içerisindeki su, yağdan kaynaklı duman ve koku oluşumunu minimize eder.
- Cihaz üzerinde bulunan 7 kademeli termostat ile ısıyı istenilen şekilde ayarlayabilme imkanı sağlar.
- Tahliye musluğu bulunmaktadır.
- Cihazdaki rezistanslar yukarı yönlü hareketli olup kolay temizlik imkanı sağlar.

EN

- Made of stainless steel.
- Stainless steel sheet construction provides hygiene, long service life and easy of cleaning.
- Ergonomic design providing convenience to users in all aspects.
- With the 7 steps thermostat on the device, it provides the opportunity to adjust the temperature as requested.
- Equipped drain tap.
- When the resistors are in the upward position, the electricity is cut off with safety switch.

|   | KOD / CODE |  (MM) |  (kg) |  |  (kW) |  |
|---|------------|--|--|---|--|---|
|  | AIM ALE47  | 400x730x300  | 57   | 380-410 V   | 3,5  | -   |
|  | AIM ALE67  | 600x730x300  | 77   | 380-410 V   | 5,5  | -   |







## TEKNİK DETAYLAR / TECHNICAL DETAILS

TR

- Paslanmaz çelikten imal edilmiştir.
- Paslanmaz sac konstrüksiyonu ile uzun ömürlü kolay temizlenebilir ve hijyeniktir.
- Kullanıcıya her yönden rahatlık sağlayan ergonomik dizayna sahiptir.
- Yağ sıcaklığı 100°C -190°C arasında termostat ile kontrol edilir.
- Cihazda emniyet amaçlı limit termostatı bulunur.
- Cihazdaki rezistanslar yukarı yönlü hareketli olup kolay temizlik imkanı sağlar.

EN

- Made of stainless steel.
- Stainless steel sheet construction provides hygiene, long service life and easy of cleaning.
- Ergonomic design providing convenience to users in all aspects.
- Oil temperature is controlled by thermostat between 100°-190°C.
- Equipped with limiting thermostat.
- When the resistors are in the upward position, the electricity is cut off with safety switch.

|   | KOD / CODE |  (MM) |  (kg) | KAPASİTE / CAPACITY       |  |  (kW) |  |
|---|------------|--|--|---------------------------|---|--|---|
|  | AIM AEF47  | 400x730x300  | 23   | Min. 6 lt<br>Max. 12 lt.  | 380-410 V   | 9  | -   |
|  | AIM AEF87  | 800x730x300  | 43   | Min. 12 lt<br>Max. 24 lt. | 380-410 V   | 18   | -   |

AGF87



AWK47





## TEKNİK DETAYLAR / TECHNICAL DETAILS

TR

- Paslanmaz çelikten imal edilmiştir.
- Paslanmaz sac konstrüksiyonu ile uzun ömürlü kolay temizlenebilir ve hijyeniktir.
- Kullanıcıya her yönden rahatlık sağlayan ergonomik dizayna sahiptir.
- Cihazda yüksek kalori sağlayan brülörler kullanılmaktadır.
- LPG ve NG seçenekleri mevcuttur.

EN

- Made of stainless steel.
- Stainless steel sheet construction provides hygiene, long service life and easy of cleaning.
- Ergonomic design providing convenience to users in all aspects.
- Specially designed tubular burner to ensure homogeneous cooking across plate surfaces.
- LPG and NG options available

|   | KOD / CODE | (MM)        | kg  | KAPASİTE / CAPACITY           | (KW) | € |
|---|------------|-------------|-----|-------------------------------|------|---|
|  | AIM AGF47  | 400x700x850 | 61  | Min. 18 lt<br>Max. 22 lt.     | 8,5  | - |
|  | AIM AGF87  | 800x700x850 | 106 | Min. 2x18 lt<br>Max. 2x22 lt. | 17   | - |

## TEKNİK DETAYLAR / TECHNICAL DETAILS

TR

- Paslanmaz çelikten imal edilmiştir.
- Paslanmaz sac konstrüksiyonu ile uzun ömürlü kolay temizlenebilir ve hijyeniktir.
- Cihaz içerisinde yağın süzülmesi için delikli sac bulunmaktadır.
- Cihazda seramik rezistans kullanılmıştır.

EN

- Made of stainless steel.
- Stainless steel sheet construction provides hygiene, long service life and easy of cleaning.
- Equipped with porcelain heater.
- Used for holding chips at perfect serving temperature and condition.

|   | KOD / CODE | (MM)        | kg | KAPASİTE / CAPACITY | (KW)              | € |
|---|------------|-------------|----|---------------------|-------------------|---|
|  | AIM AWK47  | 400x730x300 | 19 | GN 1/1 150          | 220-240 V<br>0,65 | - |

ELEKTRİKLİ BENMARI  
ELECTRICAL BAINMARIE

BN87





## TEKNİK DETAYLAR / TECHNICAL DETAILS

TR

- Paslanmaz çelikten imal edilmiştir.
- Paslanmaz sac konstrüksiyonu ile uzun ömürlü kolay temizlenebilir ve hijyeniktir.
- Cihaz 30°- 90°C aralığında termostat ile kontrol edilir.
- Cihazda kilitli boşaltma vanası sayesinde kullanıcı kontrolü dışında açılıp boşaltma yapılamaz.

EN

- Made of stainless steel.
- Stainless steel sheet construction provides hygiene, long service life and easy of cleaning.
- Ergonomic design providing convenience to users in all aspects.
- The device is controlled by a thermostat in the range of 30°-90°C .

|  | KOD / CODE | (MM)        | kg | KAPASİTE / CAPACITY | (V)       | (KW) | € |
|--|------------|-------------|----|---------------------|-----------|------|---|
|  | AIM BN47   | 400x730x300 | 21 | GN 1/1 150          | 220-240 V | 1,5  | - |
|  | AIM BN87   | 800x730x300 | 36 | GN 1/1 150 x 2      | 220-240 V | 3    | - |

ELEKTRİKLİ MAKARNA HAŞLAMALAR  
ELECTRICAL PASTA COOKERS

PC66





## TEKNİK DETAYLAR / TECHNICAL DETAILS

TR

- Paslanmaz çelikten imal edilmiştir.
- Paslanmaz sac konstrüksiyonu ile uzun ömürlü kolay temizlenebilir ve hijyeniktir.
- Cihazda kilitli boşaltma vanası sayesinde kullanıcı kontrolü dışında açılıp boşaltma yapılamaz.
- Cihazda temiz su girişi musluğu ve taşan su tahliyesi mevcuttur.
- Cihazda enerji regülatörü ile ısı kontrolü sağlanır.
- Aşırı ısınmaya karşı limit termostat bulunur.

EN

- Made of stainless steel.
- Stainless steel sheet construction provides hygiene long service life and easy of cleaning.
- The device has a locked drain valve.It cannot be turned on/off without user control.
- The device has a clean water inlet tap and an overflowing water drain.
- Heat control is provided by the energy regulator in the device.
- It has a heat regulator against over heating.

|   | KOD / CODE | (MM)        | kg | (V)       | (KW) | € |
|---|------------|-------------|----|-----------|------|---|
|  | AIM PC47   | 400x730x300 | 21 | 380-410 V | 5    | - |
|  | AIM PC67   | 600x730x300 | 28 | 380-410 V | 7,5  | - |
|  | AIM PC87   | 800x730x300 | 36 | 380-410 V | 10   | - |

ELEKTRİKLİ SETALTI FIRINLAR  
ELECTRICAL UNDERCOUNTER OVENS

## TEKNİK DETAYLAR / TECHNICAL DETAILS

TR

- Paslanmaz çelikten imal edilmiştir.
- Paslanmaz sac konstrüksiyonu ile uzun ömürlü kolay temizlenebilir ve hijyeniktir.
- Cihazda bulunan rezistanslar 50°-300°C aralığında çalışır. isteğe göre ayrı ayrı kontrol edilebilir.
- ST modellerinde; cihazın tabanında ısıyı homojen olarak dağıtmak için 10 mm. kalınlığında ST Serisi çelik plate bulunmaktadır.
- F modellerinde; fırında iç hacmi homojen olarak ısıtan AC fan bulunmaktadır.
- Ürün üzerinde aynı seriden farklı ürünler konumlandırılabilir.
- Fırın içerisinde 2 adet 530 x 400 mm. tel ızgara bulunmaktadır.

EN

- Made of stainless Steel
- Stainless steel sheet construction provides hygiene, long service life and easy of cleaning.
- The resistances in the device operate in the range of 50°-300°C degrees. It can be individually controlled optionally.
- In the ST model, in order to homogenize the heat at the base of the device, 10mm thick ST model steel is produced.
- There is an AC fan that heats the internal volume homogeneously in F models.
- Different products from the same series can be put on the product.
- There are 2 pieces 530x400 mm wire grids in the oven.

|  | KOD / CODE  | (MM)         | kg | KAPASİTE / CAPACITY | (KW)      | €   |       |
|--|-------------|--------------|----|---------------------|-----------|-----|-------|
|  | AIM SSEF87  | 800x730x550  | 45 | GN 2/1              | 380-415 V | 6,3 | 1.842 |
|  | AIM SFEF87  | 800x730x550  | 45 | GN 2/1              | 380-413 V | 2,6 | 1.362 |
|  | AIM SMEF127 | 1200x730x550 | 85 | 650x930             | 380-415 V | 12  | 2.071 |
|  | AIM SDEF127 | 1200x730x550 | 80 | GN 2/1              | 380-413 V | 6,3 | 1.911 |

GAZLI SETALTI FIRINLAR  
GAS UNDERCOUNTER OVENS

## TEKNİK DETAYLAR / TECHNICAL DETAILS

TR

- Paslanmaz çelikten imal edilmiştir.
- Paslanmaz sac konstrüksiyonu ile uzun ömürlü kolay temizlenebilir ve hijyeniktir.
- Fırında sıcaklık 60°-300° C aralığında bir adet termostatlı gaz musluğu ile kontrol edilir.
- Cihazda pilotlu ve termokupullu kontrol sistemi bulunmaktadır. Termokupul sayesinde alev söndüğünde cihaza gelen gaz otomatik olarak kesilir.
- LPG ve NG seçenekleri mevcuttur.

EN

- Made of stainless Steel
- Stainless steel sheet construction provides hygiene, long service life and easy of cleaning.
- The temperature in the oven is controlled by a thermostatic gas tap in the range of 60°-300°C degrees.
- The device has a pilot and thermocouple control system. When the flame goes out with the thermocouple, the gas coming to the device is automatically cut off.
- LPG and NG options available.

|  | KOD / CODE  | (MM)         | kg | KAPASİTE / CAPACITY | (KW) | €     |
|--|-------------|--------------|----|---------------------|------|-------|
|  | AIM SGF87   | 800x730x550  | 45 | GN 2/1              | 6,3  | 2.014 |
|  | AIM SMGF127 | 1200x730x550 | 85 | 650x930             | 9,5  | 2.323 |
|  | AIM SDGF127 | 1200x730x550 | 80 | GN 2/1              | 6,3  | 2.231 |

NW127









## TEKNİK DETAYLAR / TECHNICAL DETAILS

TR

- Paslanmaz çelikten imal edilmiştir.
- Paslanmaz sac konstrüksiyonu ile uzun ömürlü kolay temizlenebilir ve hijyeniktir.
- Kullanıcıya her açıdan kolaylık sağlayan ergonomik tasarım.

EN

- Made of stainless steel.
- Stainless steel sheet construction provides hygiene, long service life and easy of cleaning.
- Ergonomic design providing convenience to users in all aspects.

|   | KOD / CODE | <br>(MM) |  | € |
|---|------------|---|--|---|
|  | AIM NW47   | 400x730x300   | 16   | - |
|  | AIM NW67   | 600x730x300   | 22   | - |
|  | AIM NW87   | 800x730x300   | 27   | - |
|   | AIM NW127  | 1200x730x300  | 43   | - |

UC127









## TEKNİK DETAYLAR / TECHNICAL DETAILS

TR

- Paslanmaz çelikten imal edilmiştir.
- Paslanmaz sac konstrüksiyonu ile uzun ömürlü kolay temizlenebilir ve hijyeniktir.
- Kapılar çift cidarlıdır.
- Setaltı tezgahların üzerinde bulunan pimler cihazların altındaki yuvalara göre tasarlanmış olup ürünlerin tek parça olarak görünmesini sağlar.

EN

- Made of stainless steel.
- Stainless steel sheet construction provides hygiene, long service life and easy of cleaning.
- Double-wall walled.
- Pins on the undercounter cabinets are designed for the top equipment so that the products have a uniform look.

|   | KOD / CODE | <br>(MM) |  | € |
|---|------------|---|---|---|
|  | AIM UC47   | 400x730x550   | 14  | - |
|  | AIM UC67   | 600x730x550   | 18  | - |
|  | AIM UC87   | 800x730x550   | 23  | - |
|  | AIM UC127  | 1200x730x550  | 27  | - |

# ÖZEL SERİ PIŞİRİCİLER



## SPECIAL COOKING LINE



# ÖZEL SERİ PİŞİRİCİLER SPECIAL COOKING LINE

## YER OCAKLARI FLOOR TYPE COOKERS

YRG60-1



YRG60-2



## GAZLI OCAKLAR GAS COOKERS

OCK-2



OCK-4



OCK-6





### TEKNİK DETAYLAR / TECHNICAL DETAILS

#### TR

- Paslanmaz çelik gövde.
- Nikel kaplı döküm üst tabla.
- Güvenlik termostatu.
- Paslanmaz çelik ayarlanabilir ayaklar.
- Doğalgaz veya LPG ile çalışma imkanı.

#### EN

- Made of stainless steel
- Nickel plated cast iron grate
- Regulation by means of a gas tap
- With safety thermocouple.
- Stainless steel legs adjustable in height
- Operation with NG or LPG

| KOD / CODE  | <br>(MM) | <br>(KW) | € |
|-------------|---|---|---|
| AIM YRG50   | 500x500x450   | 13  | - |
| AIM YRG60-1 | 600x600x450   | 19  | - |
| AIM YRG60-2 | 600x600x450   | 28  | - |



### TEKNİK DETAYLAR / TECHNICAL DETAILS

#### TR

- Paslanmaz çelik gövde.
- Nikel kaplı döküm üst tabla.
- Hijyenik kullanım için pislik tavası.
- Kapaksız alt depolama alanı.
- Yüksek performanslı brülör.
- Paslanmaz çelik ayarlanabilir ayaklar.
- Doğalgaz veya LPG ile çalışma imkanı.

#### EN

- Made of stainless steel
- Burners of nickel cast iron
- Very high efficiency
- With catching plate for cooking liquid
- Regulation through gas valve With open cabine
- Operation with NG or LPG

| KOD / CODE | <br>(MM) | <br>(KW) | € |
|------------|---|---|---|
| AIM OCK-2  | 400x700x850   | 2x6,5   | - |
| AIM OCK-4  | 700x700x850   | 4x6,5   | - |
| AIM OCK-6  | 1100x700x850  | 6x6,5   | - |

## ÖZEL SERİ PİŞİRİCİLER SPECIAL COOKING LINE

### SETÜSTÜ OCAKLARI TABLETOP GAS COOKERS

STO-3



### ELEKTRİKLİ SETÜSTÜ FRİTÖZLER ELECTRICAL TABLETOP FRYERS

FRT-F2





#### TEKNİK DETAYLAR / TECHNICAL DETAILS

TR

- Paslanmaz çelik gövde.
- Bakır brülör.
- Paslanmaz çelik yağ toplama haznesi.
- Doğalgaz veya LPG ile çalışma imkanı.

EN

- Made of stainless steel
- Copper burner.
- Stainless steel collection trays
- Operation with NG or LPG

| KOD / CODE |  [MM] |  (KW) | € |
|------------|--|--|---|
| AIM STO-1  | 370x-x200  | 7  | - |
| AIM STO-2  | 690x-x200  | 14   | - |
| AIM STO-3  | 1010x-x200   | 21   | - |





#### TEKNİK DETAYLAR / TECHNICAL DETAILS

TR

- Paslanmaz çelik gövde.
- Güvenlik termostati.
- 12+12 Lt hazne kapasitesi
- Ön tahliye vanası

EN

- Made of stainless steel
- Safety Thermostat.
- 12+12 Lt capacity.
- Oil drain valve

| KOD / CODE |  [MM] |  kg | KAPASİTE / CAPACITY |  |  (KW) | € |
|------------|--|--|---------------------|---|--|---|
| AIM FRT-M1 | 325x650x410  | 25   | 12 lt.              | 380-410 V   | 9  | - |
| AIM FRT-M2 | 650x650x410  | 35   | 12+12 lt.           | 380-410 V   | 18   | - |

ELEKTRİKLİ AMERİKAN TİP FRİTÖZ  
ELECTRICAL AMERICAN TYPE FRYER

FRT-E



## TEKNİK DETAYLAR / TECHNICAL DETAILS

TR

- Derin soğuk bölge
- Kızartma yağının ömrünü uzatan derin bir soğuk bölge vardır.
- Kızartma kabı tamamen paslanmaz çelikten yapılmıştır ve termal korumalıdır.
- Bölünmüş tank, 2 ayrı ayarlanabilir termostat.
- Eşit ısı dağılımı

EN

- Deep cold zone
- There is a deep cold zone which extends the life of the frying oil
- The frypot is made entirely of stainless steel, with thermal protection.
- Split tank.
- Homogeneous heat distribution

| KOD / CODE | (MM)        | kg | KAPASİTE / CAPACITY |           | (KW) | € |
|------------|-------------|----|---------------------|-----------|------|---|
| AIM FRT-E1 | 420x832x850 | 91 | 2x13 lt.            | 380-410 V | 2x9  | - |

GAZLI AMERİKAN TİP FRİTÖZ  
GAS AMERICAN TYPE FRYER

FRT-G



## TEKNİK DETAYLAR / TECHNICAL DETAILS

TR

- Paslanmaz çelikten imal edilmiştir.
- Paslanmaz sac konstrüksiyonu ile uzun ömürlü kolay temizlenebilir ve hijyeniktir.
- Kullanıcıya her yönden rahatlık sağlayan ergonomik dizayna sahiptir.
- Cihazda yüksek kalori sağlayan brülörler kullanılmaktadır.
- Cihaz üzerinde bulunan 7 kademeli termostat ile istenilen şekilde ayarlanabilme imkanı sağlar.
- Cihazda pilotlu ve termokupullu kontrol sistemi bulunmaktadır. Termokupul sayesinde alev söndüğünde cihaza gelen gaz otomatik olarak kesilir.

EN

- Made of stainless steel.
- Stainless steel sheet construction provides hygiene, long service life and easy of cleaning.
- Ergonomic design providing convenience to users in all aspects.
- LPG and NG options available
- Specially designed tubular burner to ensure homogeneous cooking across plate surfaces.
- With the 7 steps thermostat on the device, it provides the opportunity to adjust the temperature as requested.

| KOD / CODE | (MM)         | kg | KAPASİTE / CAPACITY | (KW) | € |
|------------|--------------|----|---------------------|------|---|
| AIM FRT-G1 | 316x760x1110 | 61 | 15 lt.              | 21   | - |
| AIM FRT-G2 | 400x760x1110 | 78 | 21 lt.              | 27   | - |
| AIM FRT-G3 | 560x760x1110 | 91 | 45 lt.              | 49   | - |

## ÖZEL SERİ PİŞİRİCİLER SPECIAL COOKING LINE

### GAZLI VE ELEKTRİKLİ DUTCH TİP FRİTÖZ GAS & ELECTRICAL DUTCH TYPE FRYERS

FRT-ED3

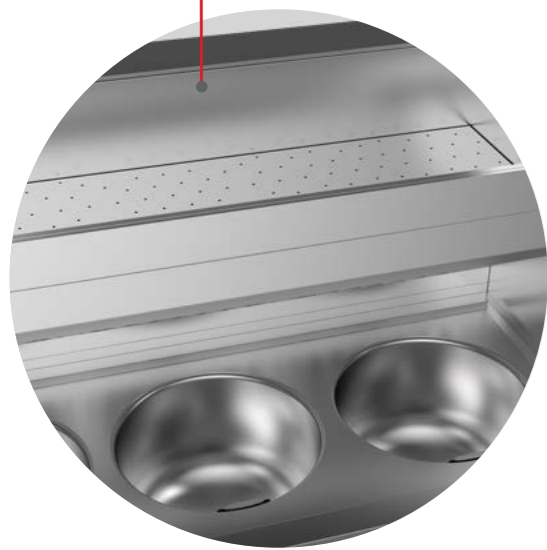

### TEKNİK DETAYLAR / TECHNICAL DETAILS

TR

- Üç yuvarlak kazanlı, paslanmaz çelikten (AISI 304/441) yapılmış sağlam gazlı fritöz. Fritöz, küvet başına saatte 50 kilogram (ön kızartma saatte 25 kilogram) kızartma kapasitesine sahiptir.
- 36 cm çapında (paslanmaz çelik kapaklar dahil) üç adet 13 litrelik küvet, alt süzgeci olan soğuk bölgelerle donatılmıştır
- Çift cidarlı üç döner kapı (yalıtlımlı)
- Her küvet için düşük tahliye musluğu ve çıkarılabilir ağızlı tahliye (veya filtreleme) (tam güvenlik içinde kolay kullanım)
- Drenaj için alt kısmı delikli, önceden pişirilmiş gıdalar için üst tepsi
- Çok yüksek verimli, yalıtlımlı yanma odasına sahip dairesel dökme demir brülör ile ısıtma
- Yanma gazlarını boşaltmak için baca (küvet başına bir adet)
- Termokupl ve piezo ateşlemeli bir güvenlik sistemi ile donatılmış "SIT" tipi termostatik gaz musluğu.
- Her bir küvetin ön tarafındaki sıcaklığın "analog" görüntüsü (7 cm çap)
- CE standartlarını karşılar

EN

- Robust gas deep fryer made of stainless steel (AISI 304/441) with three round tubs. The fryer has a frying capacity of 50 kilograms per hour (pre-frying 25 kilograms per hour) per tub.
- Three 13 liter tubs with a diameter of 36 cm (stainless steel lids included), equipped with cold zones with bottom sieve
- Three revolving doors with double walls (insulated)
- Low drain tap for each tub and drain (or filtration) with removable spout (easy use in complete safety)
- Top tray for pre-cooked foods, with a perforated bottom for drainage
- Heating by circular cast iron burner with very high efficiency, insulated combustion chamber
- Chimney (one per tub) to discharge the combustion gases
- Thermostatic gas tap type "SIT", equipped with a safety system by thermocouple and piezo ignition.
- Analogue" image of the temperature on the front of each tub (7cm diameter)
- Meets CE standards

### GAZ-GAS

| KOD / CODE  | (MM)          | KAPASİTE / CAPACITY | (KW) | € |
|-------------|---------------|---------------------|------|---|
| AIM FRT-GD1 | 550x920x1610  | 13 lt.              | 17   | - |
| AIM FRT-GD2 | 1000x920x1610 | 13x2 lt.            | 17x2 | - |
| AIM FRT-GD3 | 1450x920x1610 | 13x3 lt.            | 17x3 | - |

### ELEKTRİK-ELECTRICAL

| KOD / CODE  | (MM)          | KAPASİTE / CAPACITY | (KW)      | €    |   |
|-------------|---------------|---------------------|-----------|------|---|
| AIM FRT-ED1 | 550x920x1610  | 13 lt.              | 380-410 V | 11   | - |
| AIM FRT-ED2 | 1000x920x1610 | 13x2 lt.            | 380-410 V | 11x2 | - |
| AIM FRT-ED3 | 1450x920x1610 | 13x3 lt.            | 380-410 V | 11x3 | - |

# ÖZEL SERİ PİŞİRİCİLER SPECIAL COOKING LINE

## WOK OCAKLARI WOK RANGES



## WOK OCAKLARI WOK RANGES



### TEKNİK DETAYLAR / TECHNICAL DETAILS

#### TR

- Paslanmaz çelik AISI 304
- Güçlü dökme demir wok Ø 280 mm
- Daha yüksek performans elde etmek için 1 adet özel tasarım boru brülör
- 400 mm sırtlık
- Üst tabla kalınlığı 5 mm
- Kolay kullanım için kontrol panelinde entegre musluklu soğuk su musluğu
- Wok'un üzerinden su tahliyesine akacak olan soğutma suyu taşıma sistemi

#### EN

- Stainless steel AISI 304
- Strong cast iron wok ø 280 mm
- Special design of 1 pipe burners to get a higher performance
- Top with splashback of 400 mm
- Table top thickness 5 mm
- Cold water faucet with integrated tap in the control panel for easy use
- Cooling water overflow system which will flows above the wok into the water drain

| KOD CODE | (MM)          | WOK BURNER<br>VOK OCAĞI | SOUP BURNER<br>ÇORBA OCAĞI | KW   | € |
|----------|---------------|-------------------------|----------------------------|------|---|
| WK-1     | 610x850x1100  | 1                       | 0                          | 27,5 | - |
| WK-1+1   | 1000x850x1100 | 1                       | 1                          | 36,7 | - |

### TEKNİK DETAYLAR / TECHNICAL DETAILS

#### TR

- Paslanmaz çelik AISI 304
- Güçlü dökme demir wok Ø 280 mm
- Daha yüksek performans elde etmek için 1+2/2+1 adet özel tasarım boru brülör
- 400 mm sırtlık
- Üst tabla kalınlığı 5 mm
- Kolay kullanım için kontrol panelinde entegre musluklu soğuk su musluğu
- Wok'un üzerinden su tahliyesine akacak olan soğutma suyu taşıma sistemi

#### EN

- Stainless steel AISI 304
- Strong cast iron wok ø 280 mm
- Special design of 1+2/2+1 pipe burners to get a higher performance
- Top with splashback of 400 mm
- Table top thickness 5 mm
- Cold water faucet with integrated tap in the control panel for easy use
- Cooling water overflow system which will flows above the wok into the water drain

| KOD CODE | (MM)          | WOK BURNER<br>VOK OCAĞI | SOUP BURNER<br>ÇORBA OCAĞI | KW   | € |
|----------|---------------|-------------------------|----------------------------|------|---|
| WK-1+2   | 1390x850x1100 | 1                       | 2                          | 45,9 | - |
| WK-2+1   | 1530x850x1100 | 2                       | 1                          | 64,2 | - |

# ÖZEL SERİ PİŞİRİCİLER SPECIAL COOKING LINE

## WOK OCAKLARI WOK RANGES

WK-2+3

WK-3+2



ÜST TABLA SOĞUTMA SİSTEMİ  
TOP COOLING SYSTEM

5 MM ÜST TABLA KALINLIĞI  
5 MM TOP THICKNESS

## WOK OCAKLARI WOK RANGES

WK-4+2

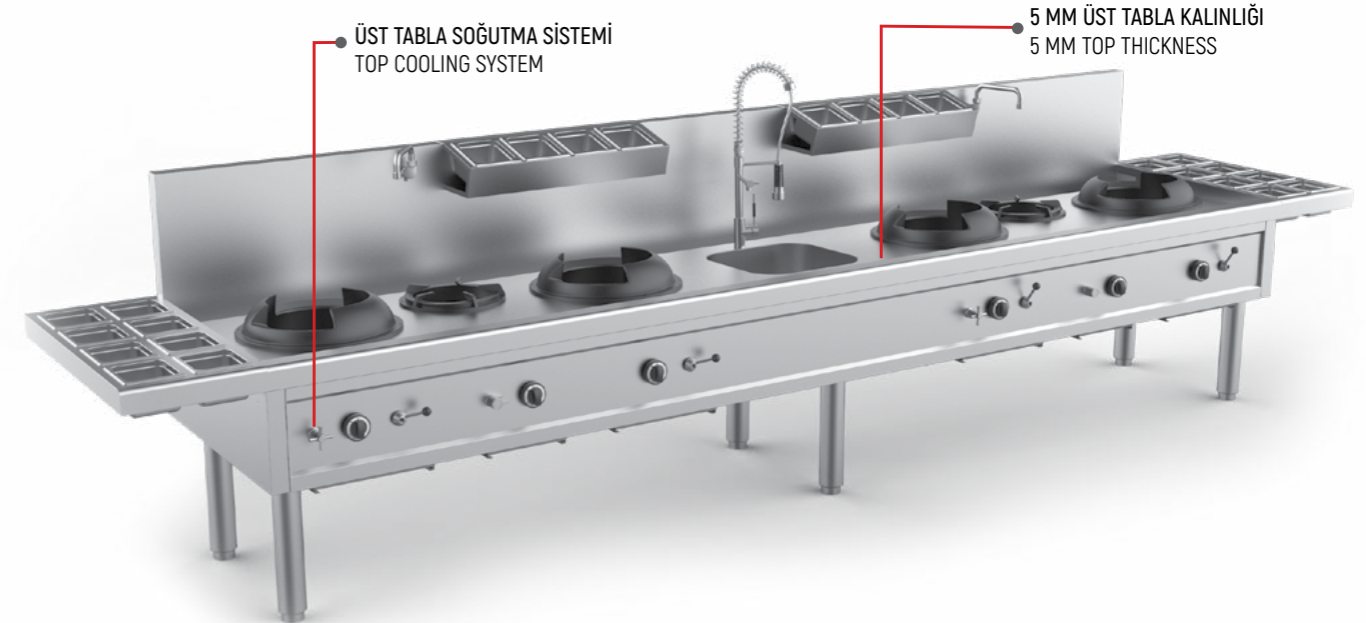

ÜST TABLA SOĞUTMA SİSTEMİ  
TOP COOLING SYSTEM

5 MM ÜST TABLA KALINLIĞI  
5 MM TOP THICKNESS

### TEKNİK DETAYLAR / TECHNICAL DETAILS

TR

- Paslanmaz çelik AISI 304
- Güçlü dökme demir wok Ø 280 mm
- Daha yüksek performans elde etmek için 2+3/3+2 adet özel tasarım boru brülör
- 400 mm sırtlık
- Üst tabla kalınlığı 5 mm
- Kolay kullanım için kontrol panelinde entegre musluklu soğuk su musluğu
- Wok'un üzerinden su tahliyesine akacak olan soğutma suyu taşıma sistemi

EN

- Stainless steel AISI 304
- Strong cast iron wok ø 280 mm
- Special design of 2+3/3+2 pipe burners to get a higher performance
- Top with splashback of 400 mm
- Table top thickness 5 mm
- Cold water faucet with integrated tap in the control panel for easy use
- Cooling water overflow system which will flows above the wok into the water drain

| KOD CODE | (MM)          | WOK BURNER<br>VOK OCAĞI | SOUP BURNER<br>ÇORBA OCAĞI | KW    | € |
|----------|---------------|-------------------------|----------------------------|-------|---|
| WK-2+3   | 2310x850x1100 | 2                       | 3                          | 82,6  | - |
| WK-3+2   | 2450x850x1100 | 3                       | 2                          | 100,9 | - |

### TEKNİK DETAYLAR / TECHNICAL DETAILS

TR

- Paslanmaz çelik AISI 304
- Güçlü dökme demir wok Ø 280 mm
- Daha yüksek performans elde etmek için 2+3/3+2 adet özel tasarım boru brülör
- 400 mm sırtlık
- Üst tabla kalınlığı 5 mm
- Kolay kullanım için kontrol panelinde entegre musluklu soğuk su musluğu
- Wok'un üzerinden su tahliyesine akacak olan soğutma suyu taşıma sistemi

EN

- Stainless steel AISI 304
- Strong cast iron wok ø 280 mm
- Special design of 2+3/3+2 pipe burners to get a higher performance
- Top with splashback of 400 mm
- Table top thickness 5 mm
- Cold water faucet with integrated tap in the control panel for easy use
- Cooling water overflow system which will flows above the wok into the water drain

| KOD CODE | (MM)        | WOK BURNER<br>VOK OCAĞI | SOUP BURNER<br>ÇORBA OCAĞI | KW    | € |
|----------|-------------|-------------------------|----------------------------|-------|---|
| WK-4+2-E | -0x850x1100 | 4                       | 2                          | 128,4 | - |



Merkez Mah. Seçkin Sok. 2-4/A  
S Blok K: 1/10 Dap Vadi  
Çağlayan - Kağıthane - İstanbul  
+90 212 982 38 91  
info@aimgastro.com

**INDUSTRIAL KITCHEN EQUIPMENT**

[www.aimgastro.com](http://www.aimgastro.com)

[f](#) [@](#) [t](#) [in](#) [v](#) /aimgastro

